

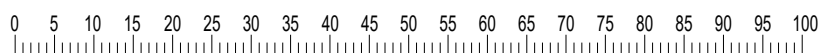

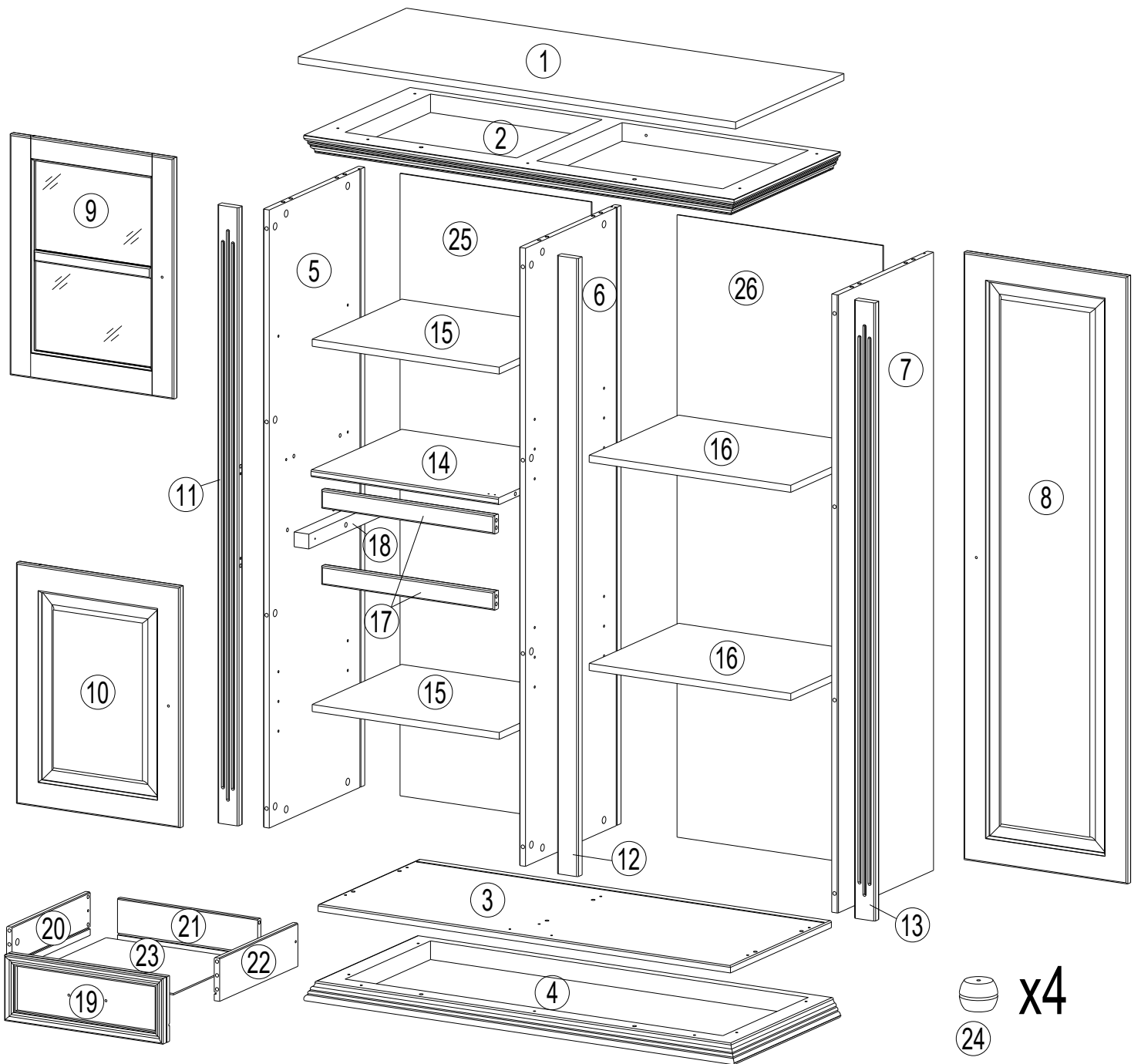

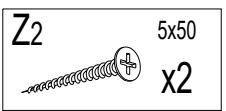

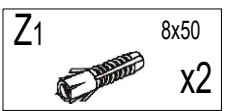

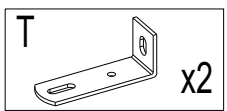
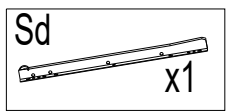
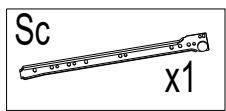
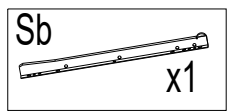
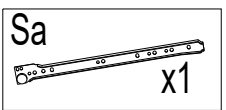
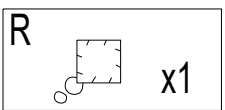
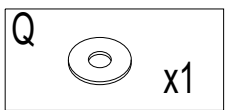
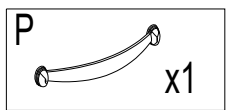
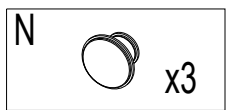
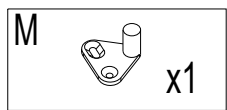
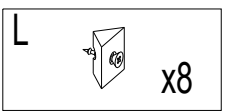
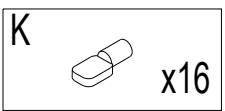
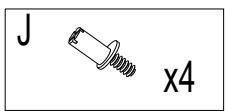
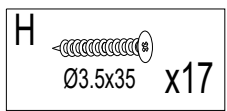
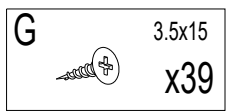
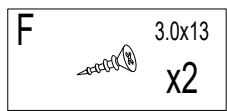
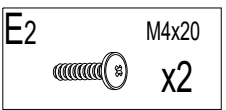
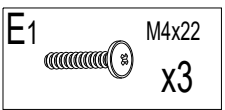
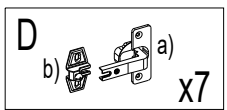
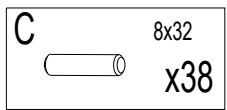
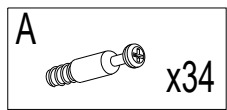
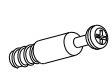

90 min

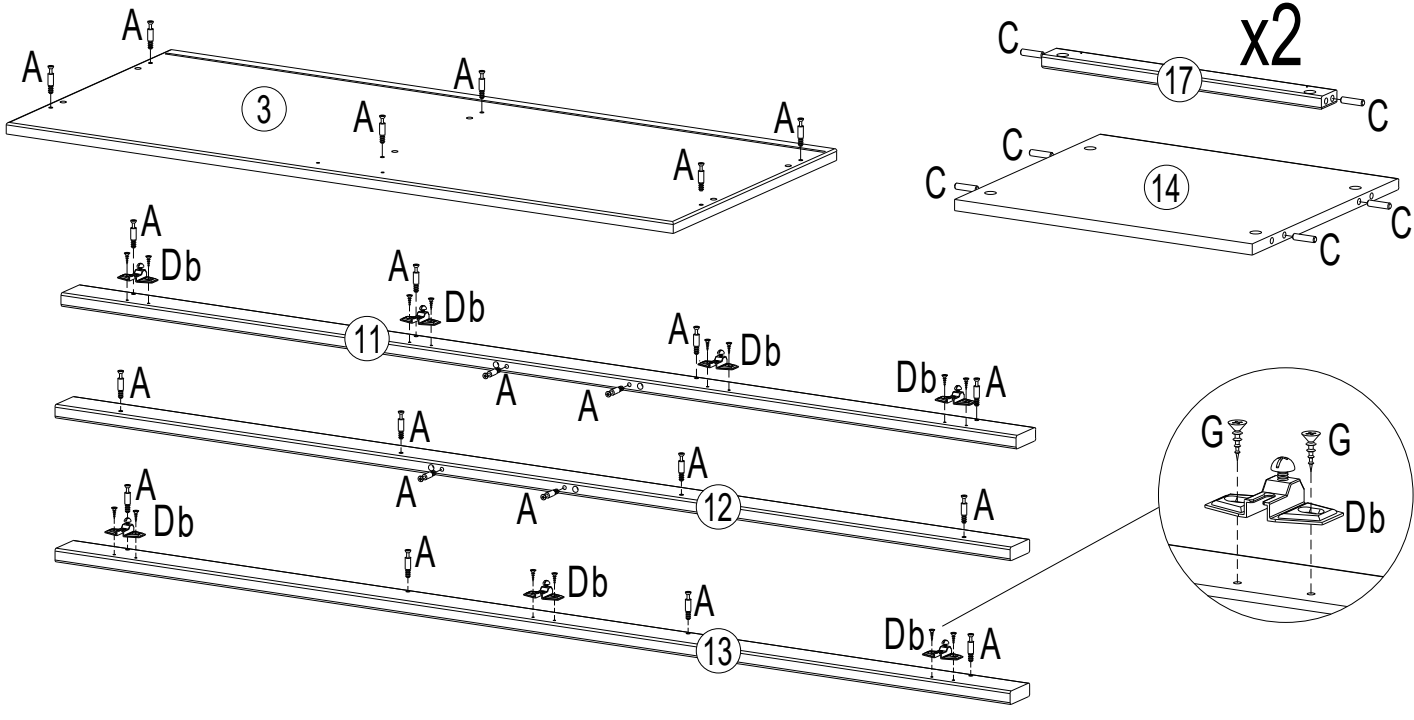

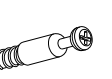
№	Size/MaB (mm)	Qty	Colli №	✓	№	Size/MaB (mm)	Qty	Colli №	✓
1	1050x450x15	1	1/2		14	450x377x15	1	1/2	
2	1033x442x40	1	1/2		15	484x372x15	2	1/2	
3	990x420x15	1	1/2		16	449x372x15	2	1/2	
4	1033x442x40	1	1/2		17	415x40x18	2	2/2	
5	1330x397x15	1	2/2		18	308x35x24	1	1/2	
6	1330x397x15	1	2/2		19	409x152x33	1	1/2	
7	1330x397x15	1	2/2		20	350x100x14	1	1/2	
8	1324x409x18	1	2/2		21	362x100x14	1	1/2	
9	540x409x18	1	2/2		22	350x100x14	1	1/2	
10	540x409x18	1	2/2		23	371x342x3	1	1/2	
11	1330x50x18	1	2/2		24	60x70x70	4	1/2	
12	1330x50x18	1	2/2		25	1339x459x3	1	2/2	
13	1330x50x18	1	2/2		26	1339x494x3	1	2/2	

- 1
- A  x22
- C  8x32 x8
- G  3.5x15 x14
- D  b) x7

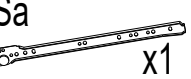

- 2
- A  x4
- B  x12
- C  8x32 x14
- G  3.5x15 x4
- Sa  x1
- Sc  x1

- H  Ø3.5x35 x1

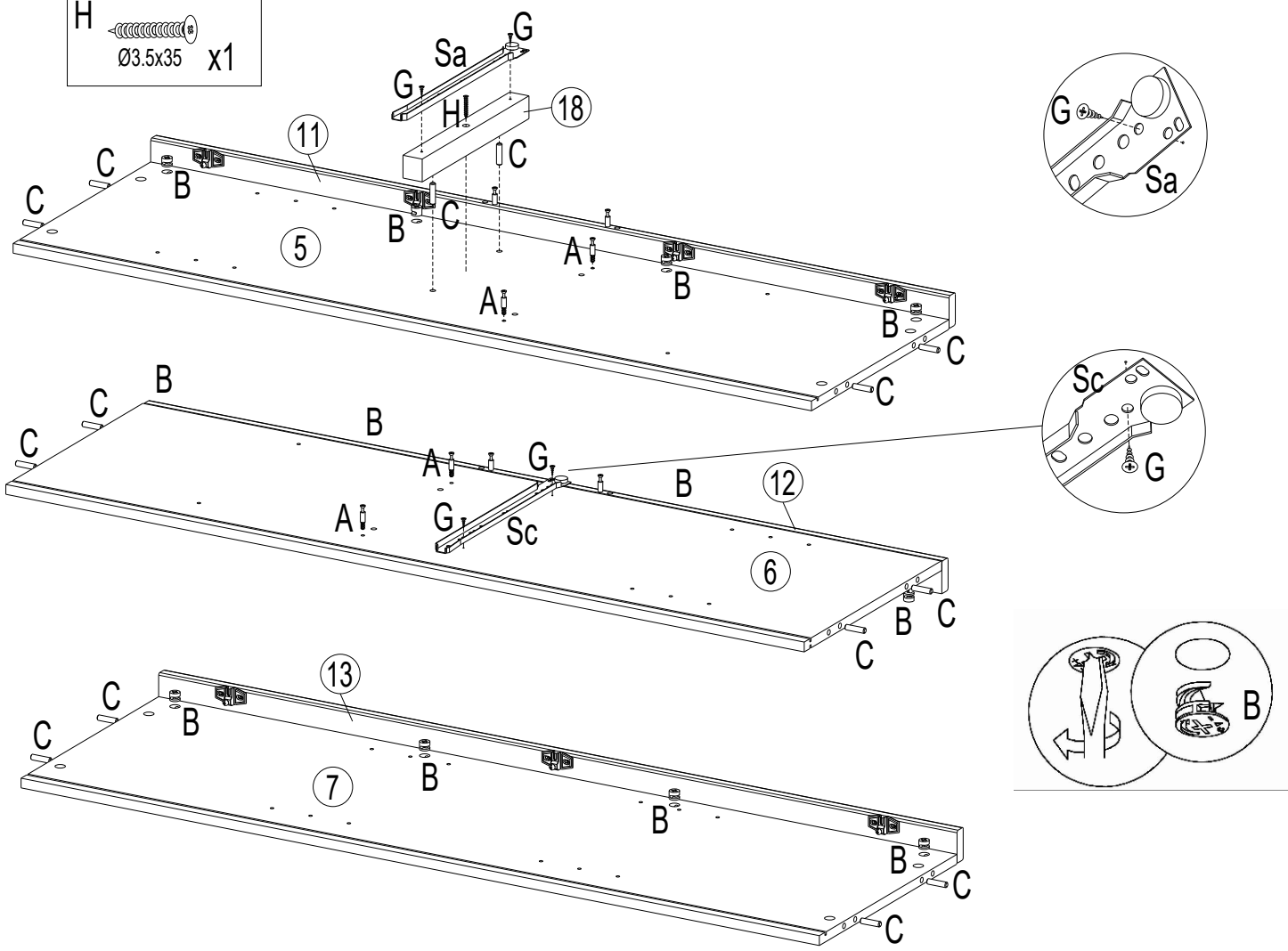

3

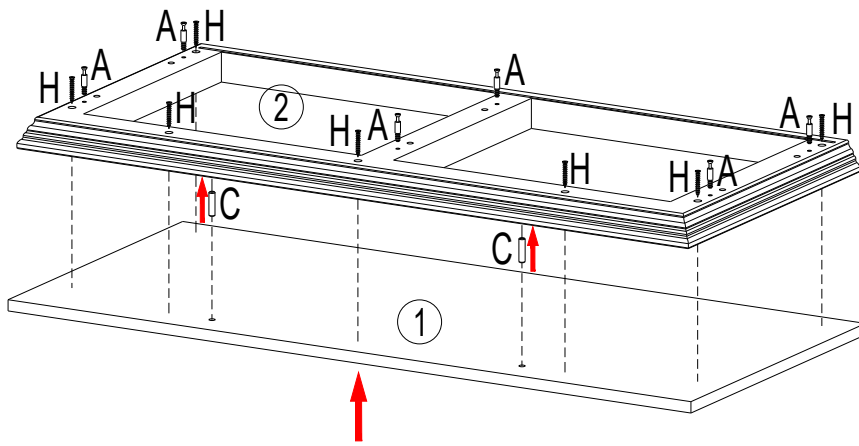
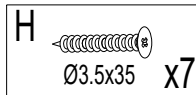
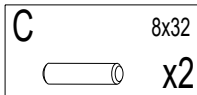
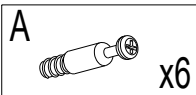

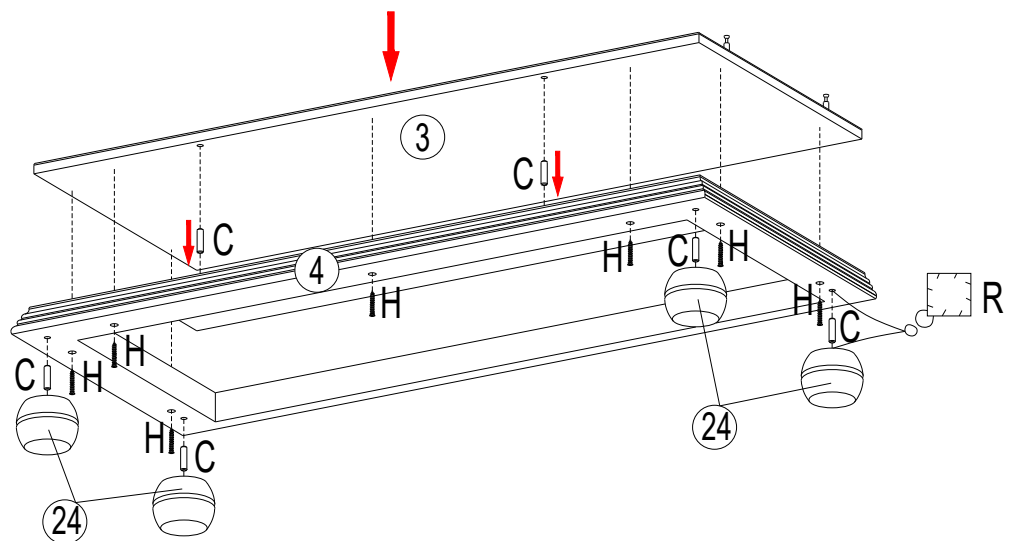
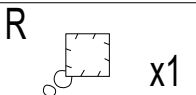
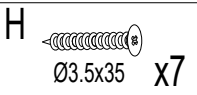
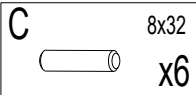

4

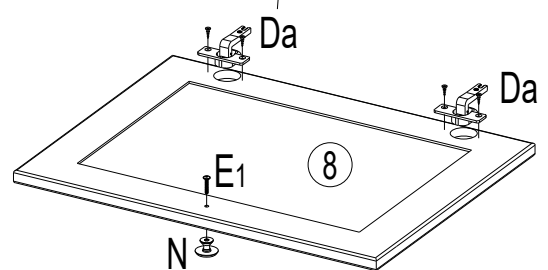
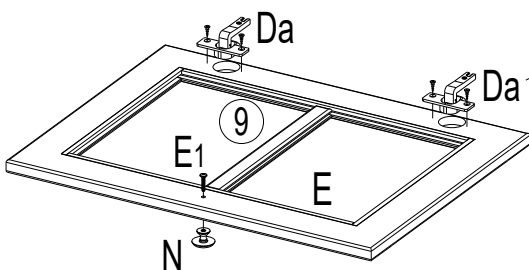
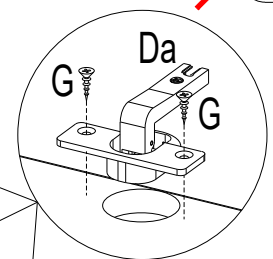
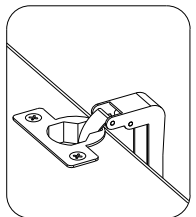
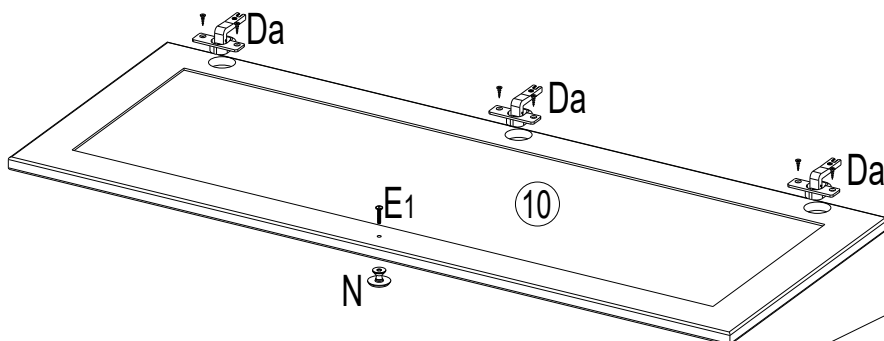
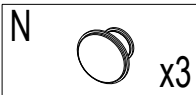
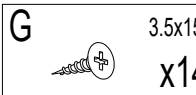
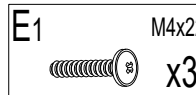
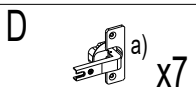

5









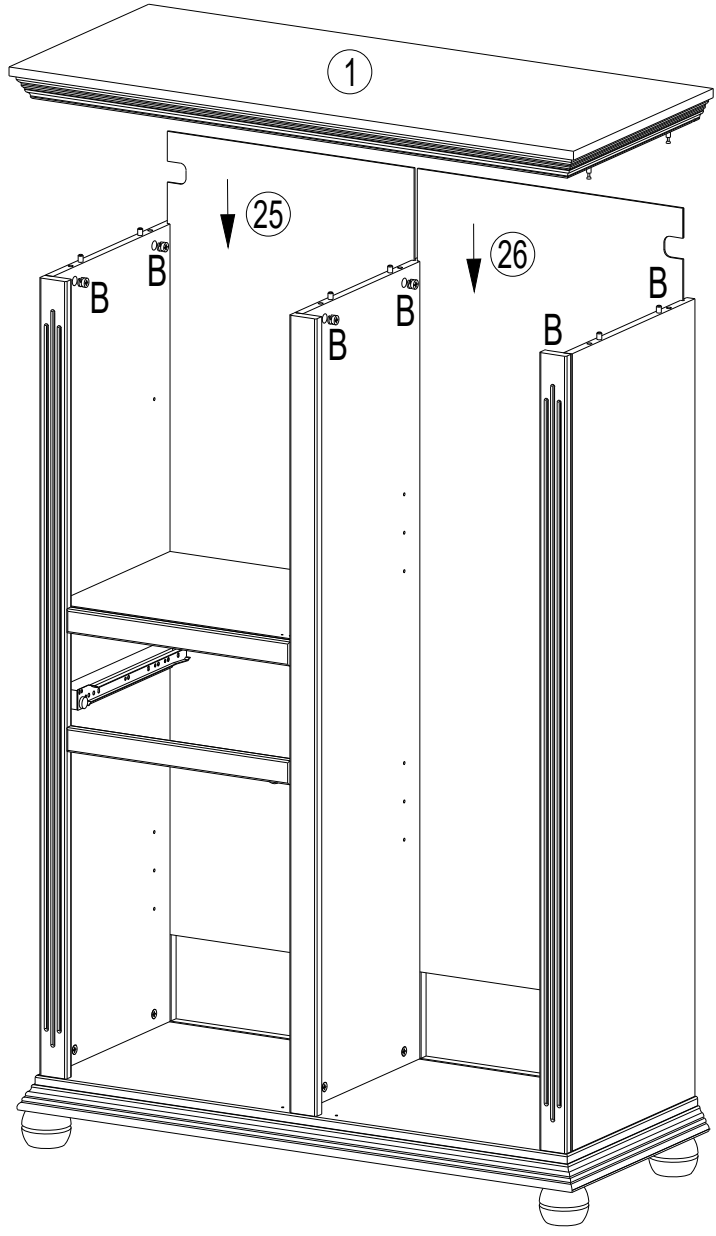
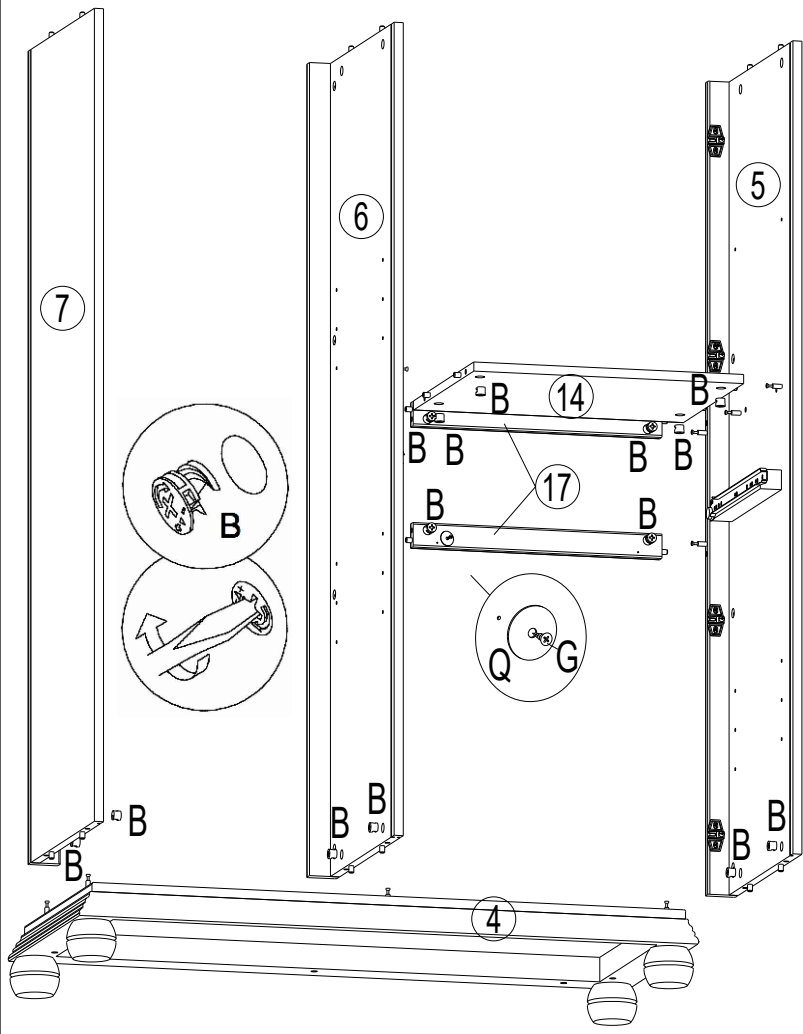

5-7

- 6 B  x14
- G  3.5x15 x1
- Q  x1

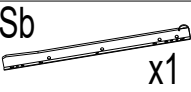
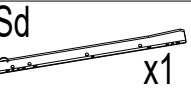
- 7 B  x6



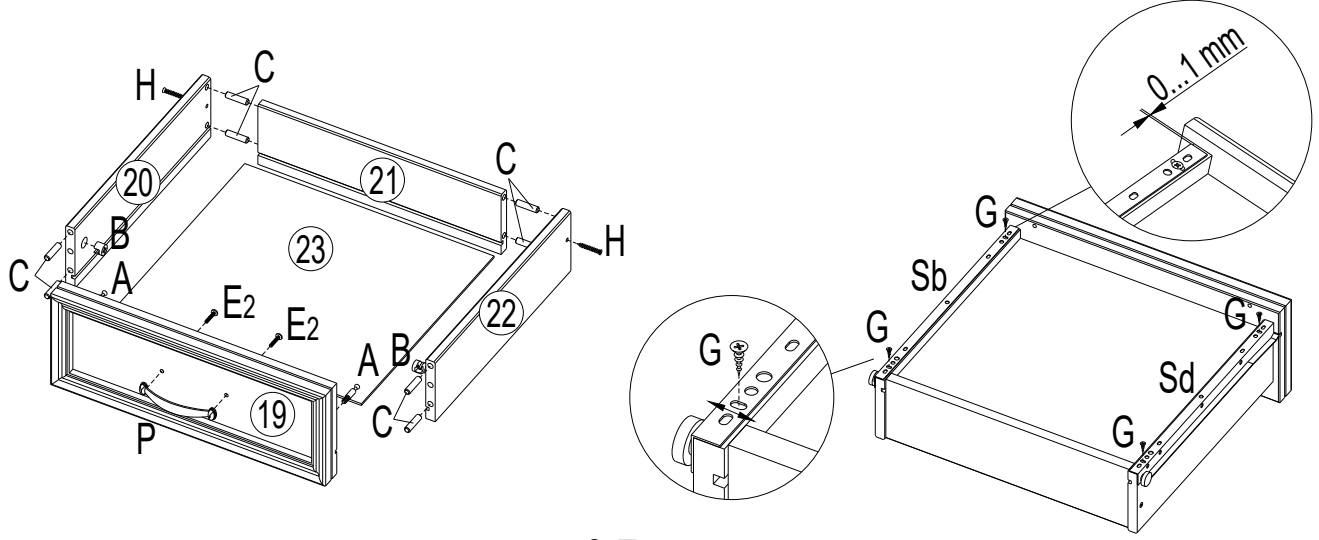

- 8 A  x2
- B  x2
- C  8x32 x8
- P  x1
- Sb  x1
- Sd  x1

- E2  M4x20 x2
- G  3.5x15 x4
- H  Ø3.5x35 x2

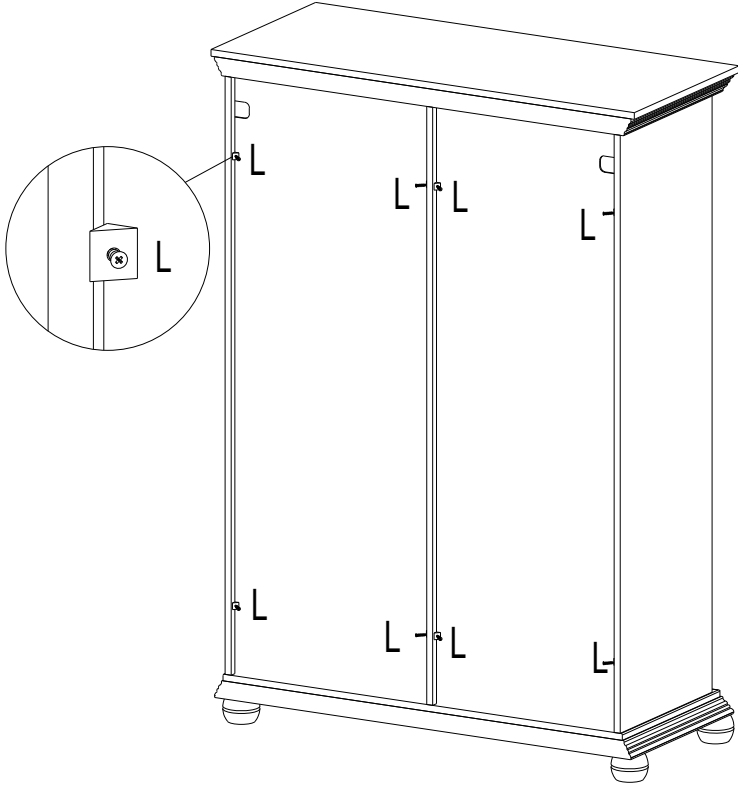

9 L  x8



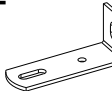

10 G  3.5x15 x2

T  x2

Z1  8x50 x2

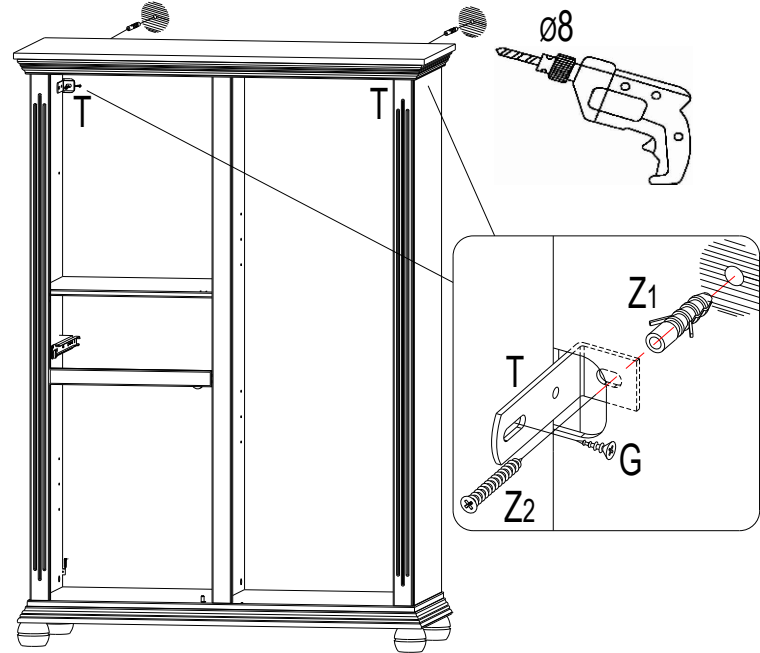
Z2  5x50 x2



11 F  3.0x13 x2

J  x4

K  x16

M  x1

