

SOLID: LINE LOWBAY EMERGENCY LIGHTS

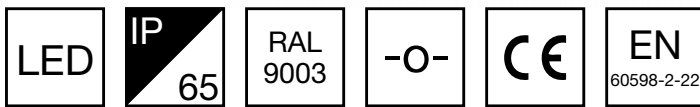

Solid Line Lowbay are designed for escape route emergency lighting. The luminaire is completely dust proof and water proof, so for example it is suitable for industrial premises, parking halls, as well as for outdoor use.

The Solid luminaire uses long-lasting LEDs as its light source.

Special attention has been paid to the design, for easy installation.

The product codes starting with letter Y include an individually packed luminaire. The product codes starting with TW include the luminaire only.

SELF-CONTAINED ESCAP EMERGENCY LIGHTS WITH SUPER CAPACITOR AND SELF-TESTING

Product Code	Nominal Supply Voltage	Feature	Backup (h)	Form
TWS4292WM	220-240 V, 50/60 Hz AC	Escap, Lumi Test	1	
Y4292WM	220-240 V, 50/60 Hz AC	Escap, Lumi Test	1	

SELF-CONTAINED ESCAP EMERGENCY LIGHTS WITH SUPER CAPACITOR AND WIRELESS CENTRAL MONITORING

Product Code	Nominal Supply Voltage	Feature	Backup (h)
TWS4292WA	220-240 V, 50/60 Hz AC	Aalto Control, Escap, Lumi Test	1
Y4292WA	220-240 V, 50/60 Hz AC	Aalto Control, Escap, Lumi Test	1

We reserve the rights to make modifications without notice.

Copyright © 2021 Teknoware. All rights reserved.

Date: February 15, 2021 | Source:

www.teknoware.com/en/emergency-lighting/emergency-lights/emergency-light-product-families/solid-line-lowbay-emergency-lights



SELF-CONTAINED EMERGENCY LIGHTS WITH BATTERY AND SELF-TESTING

Product Code	Nominal Supply Voltage	Feature	Backup (h)
TWT4252WM	220-240 V, 50/60 Hz AC	Lumi Test	1
Y4252WM	220-240 V, 50/60 Hz AC	Lumi Test	1
TWT4253WM	220-240 V, 50/60 Hz AC	Lumi Test	3
Y4253WM	220-240 V, 50/60 Hz AC	Lumi Test	3

SELF-CONTAINED EMERGENCY LIGHTS WITH BATTERY AND WIRELESS CENTRAL MONITORING

Product Code	Nominal Supply Voltage	Feature	Backup (h)
TWT4252WA	220-240 V, 50/60 Hz AC	Aalto Control, Lumi Test	1
Y4252WA	220-240 V, 50/60 Hz AC	Aalto Control, Lumi Test	1
TWT4253WA	220-240 V, 50/60 Hz AC	Aalto Control, Lumi Test	3
Y4253WA	220-240 V, 50/60 Hz AC	Aalto Control, Lumi Test	3

ADDRESSABLE 230 V CENTRALLY SUPPLIED EMERGENCY LIGHTS

Product Code	Nominal Supply Voltage	Feature
TWT4251WK	220-240 V, 50/60 Hz AC, DC	Intelligent Controller, Tapsa Control
Y4251WK	220-240 V, 50/60 Hz AC, DC	Intelligent Controller, Tapsa Control

NON-ADDRESSABLE 230 V CENTRALLY SUPPLIED EMERGENCY LIGHTS

Product Code	Nominal Supply Voltage	Feature
TWT4271W	24-230 V, 50/60 Hz AC, DC	
Y4271W	24-230 V, 50/60 Hz AC, DC	

ADDRESSABLE 24 V CENTRALLY SUPPLIED EMERGENCY LIGHTS

Product Code	Nominal Supply Voltage	Feature
TWT4241WK	24 V, 50/60 Hz AC, DC	Tapsa Control

We reserve the rights to make modifications without notice.

Copyright © 2021 Teknoware. All rights reserved.

Date: February 15, 2021 | Source:

www.teknoware.com/en/emergency-lighting/emergency-lights/emergency-light-product-families/solid-line-lowbay-emergency-lights



SOLID LINE LOWBAY EMERGENCY LIGHTTTWS4292WA

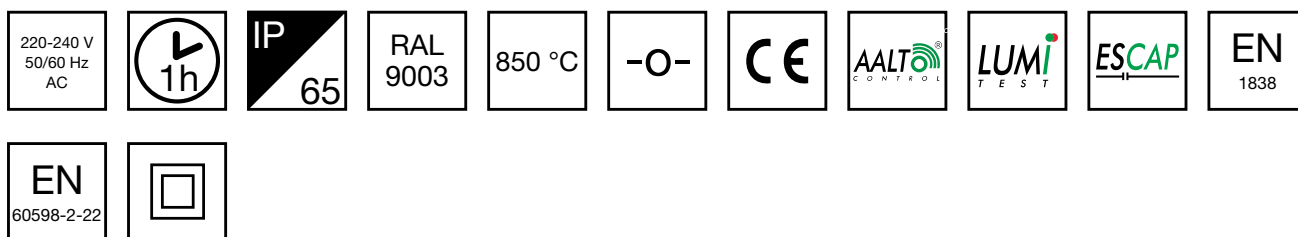

Self-contained ESCAP Emergency Light with 1 h Super Capacitor and Wireless Central Monitoring

Solid Line Lowbay are designed for escape route emergency lighting. The luminaire is completely dust proof and water proof, so for example it is suitable for industrial premises and parking halls. ESCAP and centrally supplied luminaires are also suitable for outdoor use.

The Solid luminaire uses long lasting leds as its light source.

Special attention has been paid to the design, for easy installation.

INDIVIDUALLY PACKED LIGHTS

The product codes starting with letter Y include an individually packed luminaire. The product codes starting with TW include the luminaire only.

Product Code	IP Class	Luminous Flux (lm)
Y4292WA	IP65	90

Product Code	TWS4292WA
Feature	Aalto Control, Escap, Lumi Test
Mounting (standard)	surface
Customs Code	94056080
GTIN Code	6438045021157
ETIM Product Class	EC001957
Length	371 mm
Width	181 mm
Height	57 mm
Weight	1,1 kg
Backup	1 h
Max Input Power VA	3 VA
Nominal Supply Voltage	220-240 V, 50/60 Hz AC
Protection Class	II
IP Class	IP65
Temperature Range Min - Max	-25...+35 °C
Glow Wire Test of Plastic Materials	850 °C
Body Material	plastic
Colour	RAL9003
Electrical Installation	2/3 x 2,5 mm ²

We reserve the rights to make modifications without notice.
Copyright © 2021 Teknoware. All rights reserved.
Date: February 15, 2021 | Source:
www.teknoware.com/en/emergency-lighting/solid-line-lowbay-emergency-lighttws4292wa

Teknoware Oy | P.O. Box 19, 15101 Lahti | Ilmarisentie 8, 15200 Lahti Finland
Tel +358 3 883 020 | VAT-number FI01494751 | teknoware.com | emexit@teknoware.com



Emergency lighting for escape routes (ceiling mounting)

Table of 1 lux for escape routes in the middle line according to the norm EN 1838.

Level of measurement 0,02 m, measurement result with battery operation.

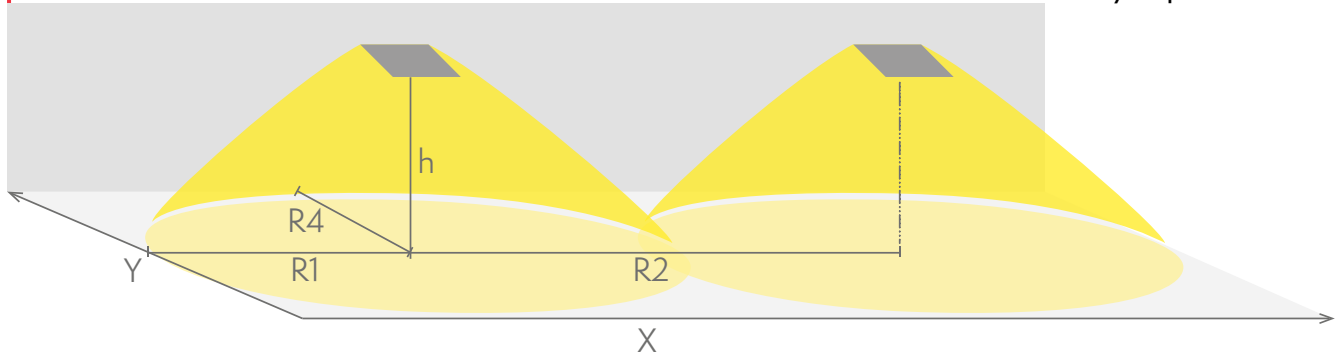

R1 distance from wall (X axis)

R2 installation distance between lights (X axis)

R4 distance from wall (Y axis)

TWS4292WA

Mounting height (m)	Below the light lux	R1 (m)	R2 (m)	R4 (m)
		1 lux	1 lux	1 lux
2,5	2,5	7	16	1
3	1,5	8	18	1

OPTIONAL ACCESSORIES:

OPTIONAL MOUNTING ACCESSORIES FOR EMERGENCY EXIT LIGHTS



Product Code	Product Name	Compatible Product Groups
TWT3006	Solid Suspension Bracket TWT3006	Solid Exit 2 Emergency Exit Lights, Solid: Line Lowbay Emergency Lights, Solid: Line Midbay Emergency Lights, Solid: Zone Lowbay Emergency Lights, Solid: Zone Midbay Emergency Lights

COMPATIBLE PRODUCTS:

We reserve the rights to make modifications without notice.

Copyright © 2021 Teknoware. All rights reserved.

Date: February 15, 2021 | Source:

www.teknoware.com/en/emergency-lighting/solid-line-lowbay-emergency-lighttws4292wa

Teknoware Oy | P.O. Box 19, 15101 Lahti | Ilmarisentie 8, 15200 Lahti Finland

Tel +358 3 883 020 | VAT-number FI01494751 | teknoware.com | emexit@teknoware.com

OPTIONAL MOUNTING ACCESSORIES FOR EMERGENCY EXIT LIGHTS

We reserve the rights to make modifications without notice.
Copyright © 2021 Teknoware. All rights reserved.
Date: February 15, 2021 | Source:
www.teknoware.com/en/emergency-lighting/solid-line-lowbay-emergency-lighttws4292wa

Teknoware Oy | P.O. Box 19, 15101 Lahti | Ilmarisentie 8, 15200 Lahti Finland
Tel +358 3 883 020 | VAT-number FI01494751 | teknoware.com | emexit@teknoware.com





Product Code	Product Name	Compatible Product Groups
TWT3006	Solid Suspension Bracket TWT3006	Solid Exit 2 Emergency Exit Lights, Solid: Line Lowbay Emergency Lights, Solid: Line Midbay Emergency Lights, Solid: Zone Lowbay Emergency Lights, Solid: Zone Midbay Emergency Lights
TWT3001	Solid Recess Mounting Frame TWT3001	Solid Exit Emergency Exit Lights, Solid Exit 2 Emergency Exit Lights, Solid: Line Lowbay Emergency Lights, Solid: Line Midbay Emergency Lights, Solid: Zone Lowbay Emergency Lights, Solid: Zone Midbay Emergency Lights
TWT3002	Solid Wall bracket TWT3002	Solid Exit Emergency Exit Lights, Solid Exit 2 Emergency Exit Lights, Solid: Line Lowbay Emergency Lights, Solid: Line Midbay Emergency Lights, Solid: Zone Lowbay Emergency Lights, Solid: Zone Midbay Emergency Lights
TWT3003	Solid Flag bracket TWT3003	Solid Exit Emergency Exit Lights, Solid Exit 2 Emergency Exit Lights, Solid: Line Lowbay Emergency Lights, Solid: Line Midbay Emergency Lights, Solid: Zone Lowbay Emergency Lights, Solid: Zone Midbay Emergency Lights
TWT3004	Solid Ceiling bracket TWT3004	Solid Exit Emergency Exit Lights, Solid Exit 2 Emergency Exit Lights, Solid: Line Lowbay Emergency Lights, Solid: Line Midbay Emergency Lights, Solid: Zone Lowbay Emergency Lights, Solid: Zone Midbay Emergency Lights

We reserve the rights to make modifications without notice.

Copyright © 2021 Teknoware. All rights reserved.

Date: February 15, 2021 | Source:

www.teknoware.com/en/emergency-lighting/solid-line-lowbay-emergency-lighttws4292wa

Teknoware Oy | P.O. Box 19, 15101 Lahti | Ilmarisentie 8, 15200 Lahti Finland

Tel +358 3 883 020 | VAT-number FI01494751 | teknoware.com | emexit@teknoware.com



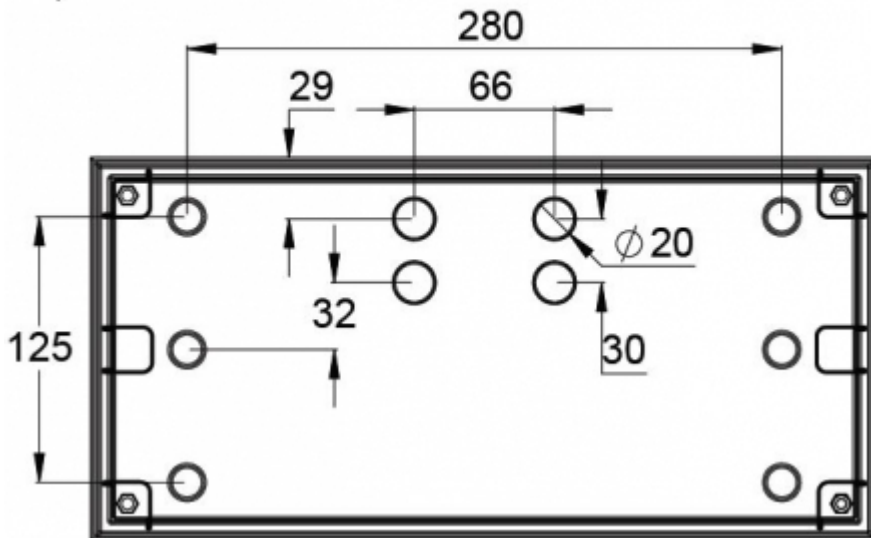
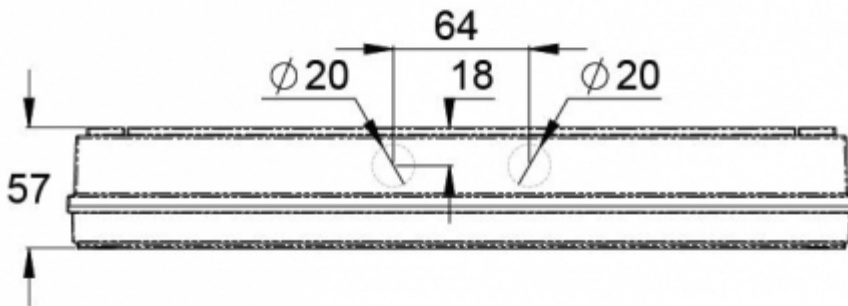
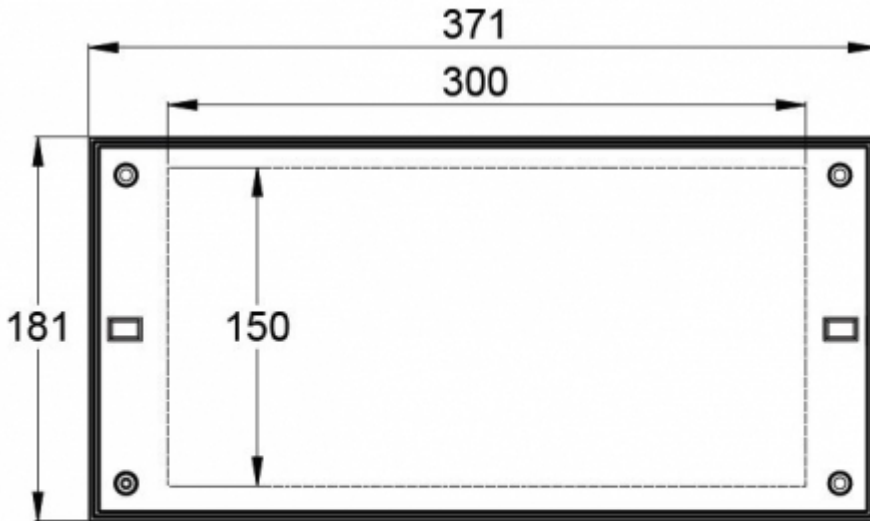

We reserve the rights to make modifications without notice.
 Copyright © 2021 Teknoware. All rights reserved.
 Date: February 15, 2021 | Source:
www.teknoware.com/en/emergency-lighting/solid-line-lowbay-emergency-lighttws4292wa

Teknoware Oy | P.O. Box 19, 15101 Lahti | Ilmarisentie 8, 15200 Lahti Finland
 Tel +358 3 883 020 | VAT-number FI01494751 | teknoware.com | emexit@teknoware.com



SOLID LINE LOWBAY EMERGENCY LIGHTTTWS4292WM

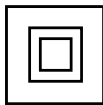
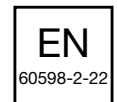
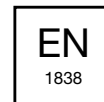
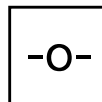
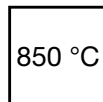
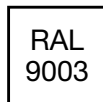
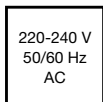

Self-contained ESCAP Emergency Light with 1 h Super Capacitor and Lumi Test Self-testing

Solid Line Lowbay are designed for escape route emergency lighting. The luminaire is completely dust proof and water proof, so for example it is suitable for industrial premises and parking halls. ESCAP and centrally supplied luminaires are also suitable for outdoor use.

The Solid luminaire uses long lasting leds as its light source.

Special attention has been paid to the design, for easy installation.

INDIVIDUALLY PACKED LIGHTS

The product codes starting with letter Y include an individually packed luminaire. The product codes starting with TW include the luminaire only.

Product Code	IP Class	Luminous Flux (lm)
Y4292WM	IP65	90

Product Code	TWS4292WM
Feature	Escap, Lumi Test
Mounting (standard)	surface
Customs Code	94056080
GTIN Code	6438045021140
ETIM Product Class	EC001957
Length	371 mm
Width	181 mm
Height	57 mm
Weight	1,5 kg
Backup	1 h
Max Input Power VA	3 VA
Nominal Supply Voltage	220-240 V, 50/60 Hz AC
Protection Class	II
IP Class	IP65
Temperature Range Min - Max	-25...+35 °C
Glow Wire Test of Plastic Materials	850 °C
Body Material	plastic
Colour	RAL9003
Electrical Installation	2/3 x 2,5 mm ²

We reserve the rights to make modifications without notice.
Copyright © 2021 Teknoware. All rights reserved.
Date: February 15, 2021 | Source:
www.teknoware.com/en/emergency-lighting/solid-line-lowbay-emergency-lighttws4292wm

Teknoware Oy | P.O. Box 19, 15101 Lahti | Ilmarisentie 8, 15200 Lahti Finland
Tel +358 3 883 020 | VAT-number FI01494751 | teknoware.com | emexit@teknoware.com



Emergency lighting for escape routes (ceiling mounting)

Table of 1 lux for escape routes in the middle line according to the norm EN 1838.

Level of measurement 0,02 m, measurement result with battery operation.

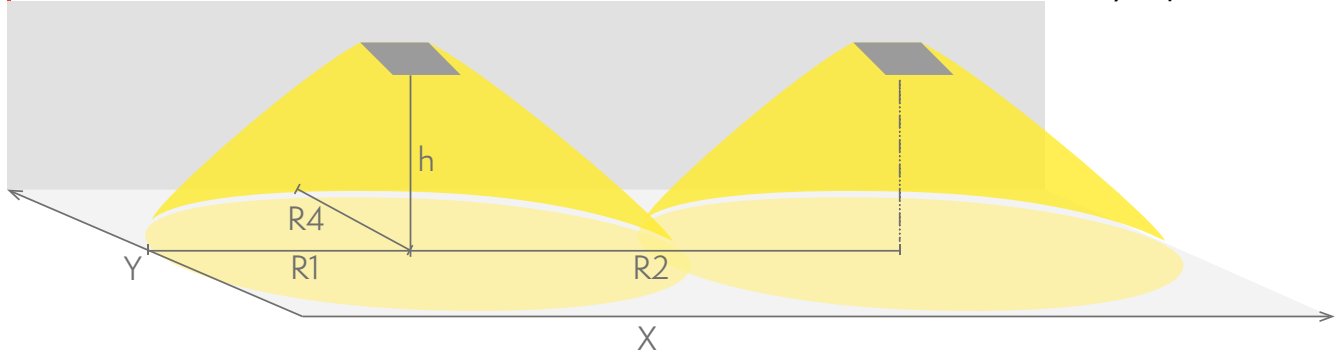

R1 distance from wall (X axis)

R2 installation distance between lights (X axis)

R4 distance from wall (Y axis)

TWS4292WM

Mounting height (m)	Below the light lux	R1 (m)	R2 (m)	R4 (m)
		1 lux	1 lux	1 lux
2,5	2,5	7	16	1
3	1,5	8	18	1

OPTIONAL ACCESSORIES:

OPTIONAL MOUNTING ACCESSORIES FOR EMERGENCY EXIT LIGHTS



Product Code	Product Name	Compatible Product Groups
TWT3006	Solid Suspension Bracket TWT3006	Solid Exit 2 Emergency Exit Lights, Solid: Line Lowbay Emergency Lights, Solid: Line Midbay Emergency Lights, Solid: Zone Lowbay Emergency Lights, Solid: Zone Midbay Emergency Lights

COMPATIBLE PRODUCTS:

We reserve the rights to make modifications without notice.

Copyright © 2021 Teknoware. All rights reserved.

Date: February 15, 2021 | Source:

www.teknoware.com/en/emergency-lighting/solid-line-lowbay-emergency-lighttws4292wm

Teknoware Oy | P.O. Box 19, 15101 Lahti | Ilmarisentie 8, 15200 Lahti Finland
Tel +358 3 883 020 | VAT-number FI01494751 | teknoware.com | emexit@teknoware.com

OPTIONAL MOUNTING ACCESSORIES FOR EMERGENCY EXIT LIGHTS

We reserve the rights to make modifications without notice.
Copyright © 2021 Teknoware. All rights reserved.
Date: February 15, 2021 | Source:
www.teknoware.com/en/emergency-lighting/solid-line-lowbay-emergency-lighttws4292wm

Teknoware Oy | P.O. Box 19, 15101 Lahti | Ilmarisentie 8, 15200 Lahti Finland
Tel +358 3 883 020 | VAT-number FI01494751 | teknoware.com | emexit@teknoware.com





Product Code	Product Name	Compatible Product Groups
TWT3006	Solid Suspension Bracket TWT3006	Solid Exit 2 Emergency Exit Lights, Solid: Line Lowbay Emergency Lights, Solid: Line Midbay Emergency Lights, Solid: Zone Lowbay Emergency Lights, Solid: Zone Midbay Emergency Lights
TWT3001	Solid Recess Mounting Frame TWT3001	Solid Exit Emergency Exit Lights, Solid Exit 2 Emergency Exit Lights, Solid: Line Lowbay Emergency Lights, Solid: Line Midbay Emergency Lights, Solid: Zone Lowbay Emergency Lights, Solid: Zone Midbay Emergency Lights
TWT3002	Solid Wall bracket TWT3002	Solid Exit Emergency Exit Lights, Solid Exit 2 Emergency Exit Lights, Solid: Line Lowbay Emergency Lights, Solid: Line Midbay Emergency Lights, Solid: Zone Lowbay Emergency Lights, Solid: Zone Midbay Emergency Lights
TWT3003	Solid Flag bracket TWT3003	Solid Exit Emergency Exit Lights, Solid Exit 2 Emergency Exit Lights, Solid: Line Lowbay Emergency Lights, Solid: Line Midbay Emergency Lights, Solid: Zone Lowbay Emergency Lights, Solid: Zone Midbay Emergency Lights
TWT3004	Solid Ceiling bracket TWT3004	Solid Exit Emergency Exit Lights, Solid Exit 2 Emergency Exit Lights, Solid: Line Lowbay Emergency Lights, Solid: Line Midbay Emergency Lights, Solid: Zone Lowbay Emergency Lights, Solid: Zone Midbay Emergency Lights

We reserve the rights to make modifications without notice.

Copyright © 2021 Teknoware. All rights reserved.

Date: February 15, 2021 | Source:

www.teknoware.com/en/emergency-lighting/solid-line-lowbay-emergency-lighttws4292wm

Teknoware Oy | P.O. Box 19, 15101 Lahti | Ilmarisentie 8, 15200 Lahti Finland

Tel +358 3 883 020 | VAT-number FI01494751 | teknoware.com | emexit@teknoware.com



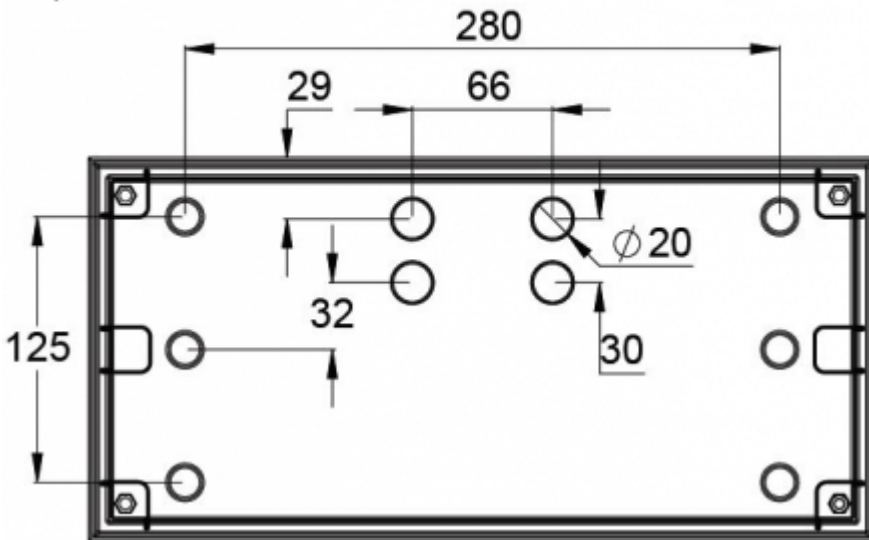
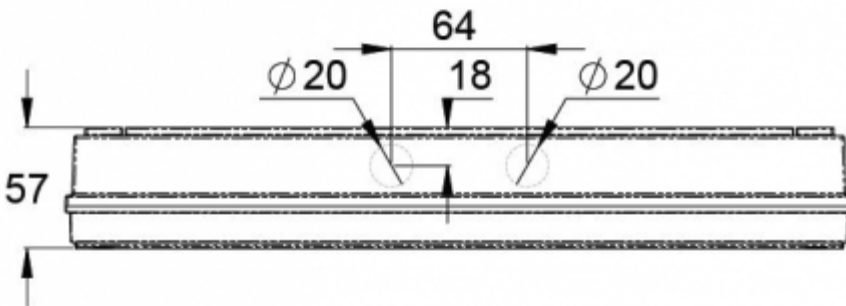
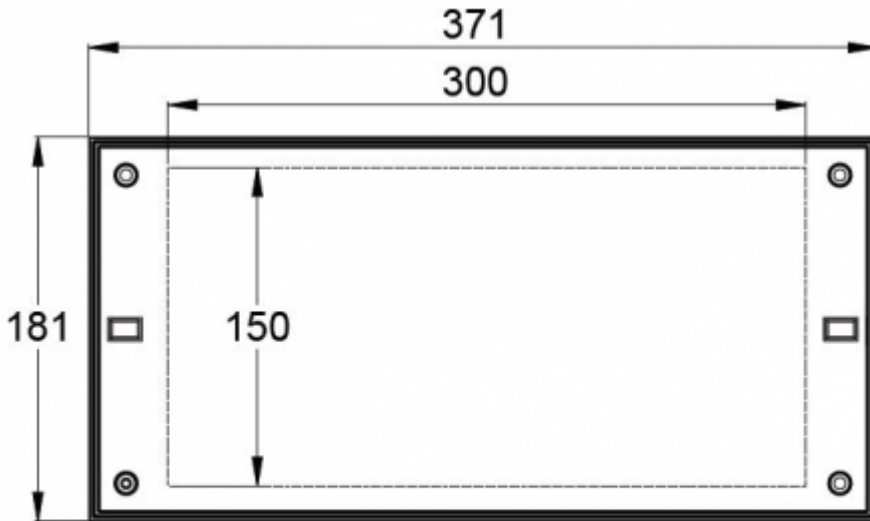

We reserve the rights to make modifications without notice.
 Copyright © 2021 Teknoware. All rights reserved.
 Date: February 15, 2021 | Source:
www.teknoware.com/en/emergency-lighting/solid-line-lowbay-emergency-lighttws4292wm

Teknoware Oy | P.O. Box 19, 15101 Lahti | Ilmarisentie 8, 15200 Lahti Finland
 Tel +358 3 883 020 | VAT-number FI01494751 | teknoware.com | emexit@teknoware.com



SOLID LINE LOWBAY LED EMERGENCY LIGHT TWT4241WK

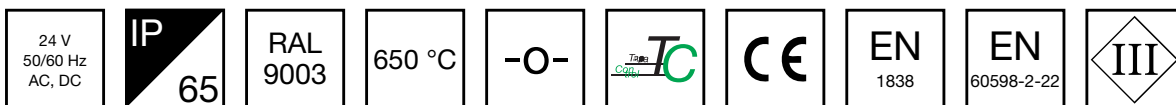

Addressable 24 V centrally supplied LED emergency light for escape routes

SOLID Line Lowbay is designed for escape route emergency lighting. The luminaire is dust- and water proof, so for example it is suitable for industrial premises and parking halls. ESCAP and centrally supplied luminaires are also suitable for outdoor use.

The SOLID luminaire uses long lasting leds as its light source.

Special attention has been paid to the design, for easy installation.

Product Code	TWT4241WK
Feature	Tapsa Control
Mounting (standard)	surface
GTIN Code	6438045023908
Length	371 mm
Width	181 mm
Height	57 mm
Weight	1,1 kg
Max Input Power VA	3,4 VA
Max Input Power W	3,4 W
Nominal Supply Voltage	24 V, 50/60 Hz AC, DC
Protection Class	III
IP Class	IP65
Temperature Range Min - Max	-30...+50 °C
Glow Wire Test of Plastic Materials	650 °C
Body Material	plastic
Colour	RAL9003
Electrical Installation	2/3 x 2,5 mm ²
Luminous Flux	220 lm

Emergency lighting for escape routes (ceiling mounting)

Table of 1 lux for escape routes in the middle line according to the norm EN 1838.

Level of measurement 0,02 m, measurement result with battery operation.

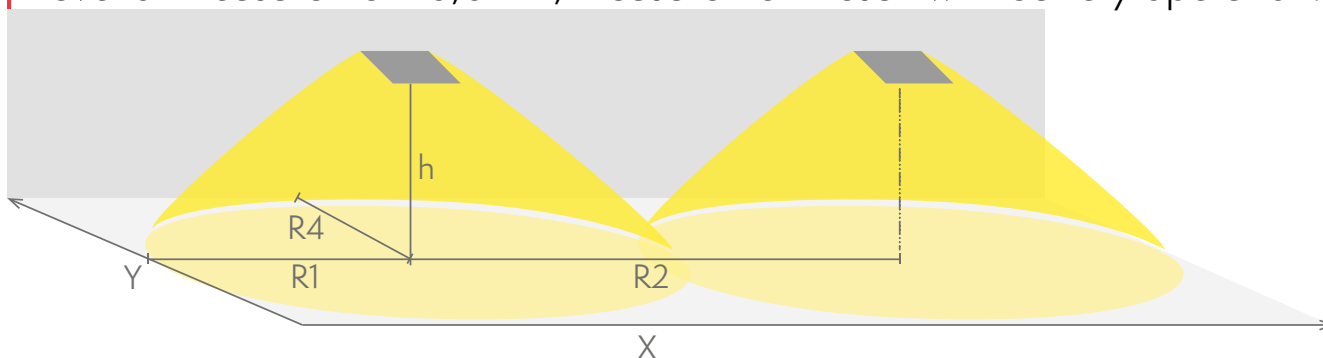

We reserve the rights to make modifications without notice.

Copyright © 2021 Teknoware. All rights reserved.

Date: February 15, 2021 | Source:

www.teknoware.com/en/emergency-lighting/solid-line-lowbay-led-emergency-light-twt4241-wk

Teknoware Oy | P.O. Box 19, 15101 Lahti | Ilmarisentie 8, 15200 Lahti Finland
Tel +358 3 883 020 | VAT-number FI01494751 | teknoware.com | emexit@teknoware.com



R1 distance from wall (X axis)
 R2 installation distance between lights (X axis)
 R4 distance from wall (Y axis)
TWT4241WK

Mounting height (m)	Below the light lux	R1 (m)	R2 (m)	R4 (m)
		1 lux	1 lux	1 lux
2,5	8	8	19	1
3	5,5	9	21	1
4	3	10	25	1

OPTIONAL ACCESSORIES:

OPTIONAL MOUNTING ACCESSORIES FOR EMERGENCY EXIT LIGHTS



Product Code	Product Name	Compatible Product Groups
TWT3006	Solid Suspension Bracket TWT3006	Solid Exit 2 Emergency Exit Lights, Solid: Line Lowbay Emergency Lights, Solid: Line Midbay Emergency Lights, Solid: Zone Lowbay Emergency Lights, Solid: Zone Midbay Emergency Lights

COMPATIBLE PRODUCTS:

OPTIONAL MOUNTING ACCESSORIES FOR EMERGENCY EXIT LIGHTS



Product Code	Product Name	Compatible Product Groups
TWT3001	Solid Recess Mounting Frame TWT3001	Solid Exit Emergency Exit Lights, Solid Exit 2 Emergency Exit Lights, Solid: Line Lowbay Emergency Lights, Solid: Line Midbay Emergency Lights, Solid: Zone Lowbay Emergency Lights, Solid: Zone Midbay Emergency Lights
TWT3002	Solid Wall bracket TWT3002	Solid Exit Emergency Exit Lights, Solid Exit 2 Emergency Exit Lights, Solid: Line Lowbay Emergency Lights, Solid: Line Midbay Emergency Lights, Solid: Zone Lowbay Emergency Lights, Solid: Zone Midbay Emergency Lights
TWT3003	Solid Flag bracket TWT3003	Solid Exit Emergency Exit Lights, Solid Exit 2 Emergency Exit Lights, Solid: Line Lowbay Emergency Lights, Solid: Line Midbay Emergency Lights, Solid: Zone Lowbay Emergency Lights, Solid: Zone Midbay Emergency Lights
TWT3004	Solid Ceiling bracket TWT3004	Solid Exit Emergency Exit Lights, Solid Exit 2 Emergency Exit Lights, Solid: Line Lowbay Emergency Lights, Solid: Line Midbay Emergency Lights, Solid: Zone Lowbay Emergency Lights, Solid: Zone Midbay Emergency Lights

We reserve the rights to make modifications without notice.
 Copyright © 2021 Teknoware. All rights reserved.
 Date: February 15, 2021 | Source:
www.teknoware.com/en/emergency-lighting/solid-line-lowbay-led-emergency-light-twt4241-wk



SOLID LINE LOWBAY LED EMERGENCY LIGHT TWT4251WK

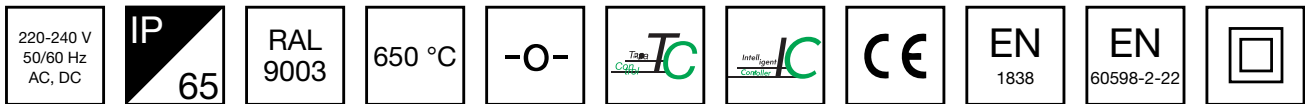

Addressable 230 V centrally supplied LED emergency light for escape routes

SOLID Line Lowbay are designed for escape route emergency lighting. The luminaire is completely dust proof and water proof, so for example it is suitable for industrial premises and parking halls. ESCAP and centrally supplied luminaires are also suitable for outdoor use.

The SOLID luminaire uses long lasting leds as its light source.

Special attention has been paid to the design, for easy installation.

INDIVIDUALLY PACKED LIGHTS

The product codes starting with letter Y include an individually packed luminaire. The product codes starting with TW include the luminaire only.

Product Code	IP Class	Luminous Flux (lm)
Y4251WK	IP65	220

Product Code	TWT4251WK
Feature	Intelligent Controller, Tapsa Control
Mounting (standard)	surface
Customs Code	94056080
GTIN Code	6438045021065
ETIM Product Class	EC001957
Length	371 mm
Width	181 mm
Height	57 mm
Weight	1,1 kg
Max Input Power VA	10 VA
Max Input Power W	6 W
Nominal Supply Voltage	220-240 V, 50/60 Hz AC, DC
Protection Class	II
IP Class	IP65
Temperature Range Min - Max	-30...+50 °C
Glow Wire Test of Plastic Materials	650 °C
Body Material	plastic
Colour	RAL9003
Electrical Installation	2/3 x 2,5 mm ²

We reserve the rights to make modifications without notice.

Copyright © 2021 Teknoware. All rights reserved.

Date: February 15, 2021 | Source:

www.teknoware.com/en/emergency-lighting/solid-line-lowbay-led-emergency-light-twt4251wk

Teknoware Oy | P.O. Box 19, 15101 Lahti | Ilmarisentie 8, 15200 Lahti Finland
Tel +358 3 883 020 | VAT-number FI01494751 | teknoware.com | emexit@teknoware.com



Emergency lighting for escape routes (ceiling mounting)

Table of 1 lux for escape routes in the middle line according to the norm EN 1838.

Level of measurement 0,02 m, measurement result with battery operation.

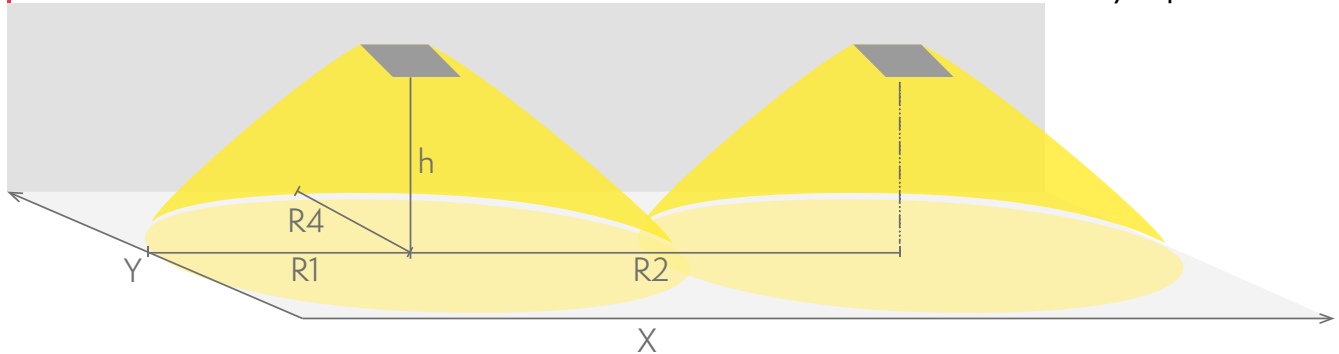

R1 distance from wall (X axis)

R2 installation distance between lights (X axis)

R4 distance from wall (Y axis)

TWT4251WK

Mounting height (m)	Below the light lux	R1 (m)	R2 (m)	R4 (m)
		1 lux	1 lux	1 lux
2,5	8	8	19	1
3	5,5	9	21	1
4	3	10	25	1

OPTIONAL ACCESSORIES:

OPTIONAL MOUNTING ACCESSORIES FOR EMERGENCY EXIT LIGHTS



Product Code	Product Name	Compatible Product Groups
TWT3006	Solid Suspension Bracket TWT3006	Solid Exit 2 Emergency Exit Lights, Solid: Line Lowbay Emergency Lights, Solid: Line Midbay Emergency Lights, Solid: Zone Lowbay Emergency Lights, Solid: Zone Midbay Emergency Lights

We reserve the rights to make modifications without notice.

Copyright © 2021 Teknoware. All rights reserved.

Date: February 15, 2021 | Source:

www.teknoware.com/en/emergency-lighting/solid-line-lowbay-led-emergency-light-twt4251-wk

Teknoware Oy | P.O. Box 19, 15101 Lahti | Ilmarisentie 8, 15200 Lahti Finland
Tel +358 3 883 020 | VAT-number FI01494751 | teknoware.com | emexit@teknoware.com

COMPATIBLE PRODUCTS:

OPTIONAL MOUNTING ACCESSORIES FOR EMERGENCY EXIT LIGHTS



Product Code	Product Name	Compatible Product Groups
TWT3001	Solid Recess Mounting Frame TWT3001	Solid Exit Emergency Exit Lights, Solid Exit 2 Emergency Exit Lights, Solid: Line Lowbay Emergency Lights, Solid: Line Midbay Emergency Lights, Solid: Zone Lowbay Emergency Lights, Solid: Zone Midbay Emergency Lights
TWT3002	Solid Wall bracket TWT3002	Solid Exit Emergency Exit Lights, Solid Exit 2 Emergency Exit Lights, Solid: Line Lowbay Emergency Lights, Solid: Line Midbay Emergency Lights, Solid: Zone Lowbay Emergency Lights, Solid: Zone Midbay Emergency Lights
TWT3003	Solid Flag bracket TWT3003	Solid Exit Emergency Exit Lights, Solid Exit 2 Emergency Exit Lights, Solid: Line Lowbay Emergency Lights, Solid: Line Midbay Emergency Lights, Solid: Zone Lowbay Emergency Lights, Solid: Zone Midbay Emergency Lights
TWT3004	Solid Ceiling bracket TWT3004	Solid Exit Emergency Exit Lights, Solid Exit 2 Emergency Exit Lights, Solid: Line Lowbay Emergency Lights, Solid: Line Midbay Emergency Lights, Solid: Zone Lowbay Emergency Lights, Solid: Zone Midbay Emergency Lights

We reserve the rights to make modifications without notice.

Copyright © 2021 Teknoware. All rights reserved.

Date: February 15, 2021 | Source:

www.teknoware.com/en/emergency-lighting/solid-line-lowbay-led-emergency-light-twt4251-wk



Teknoware Oy | P.O. Box 19, 15101 Lahti | Ilmarisentie 8, 15200 Lahti Finland

Tel +358 3 883 020 | VAT-number FI01494751 | teknoware.com | emexit@teknoware.com

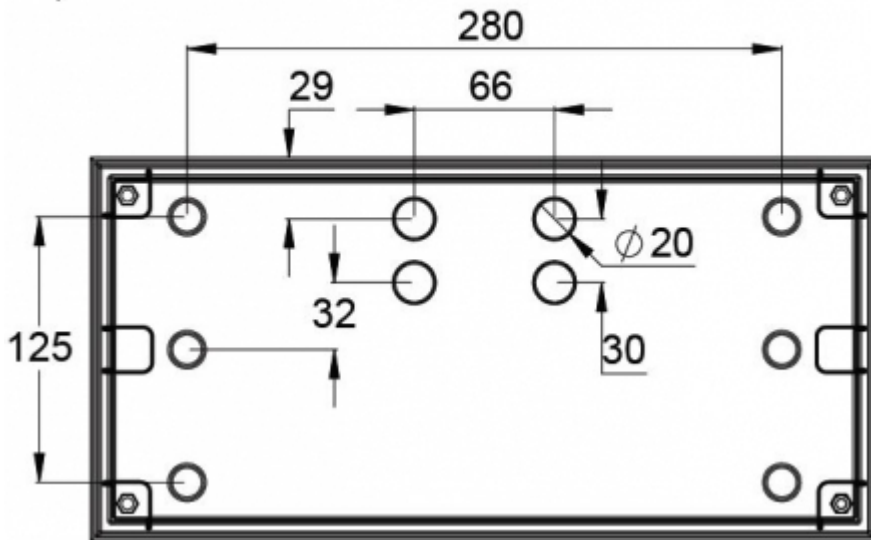
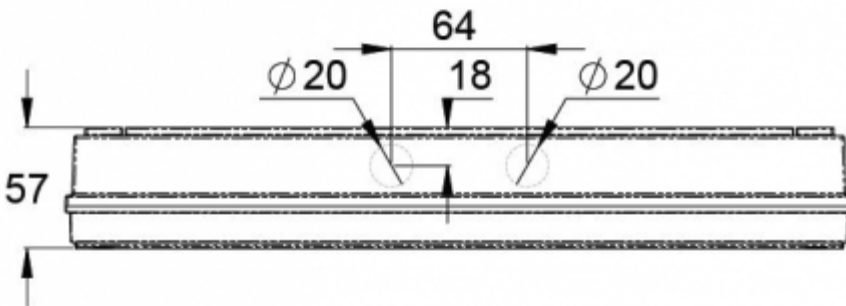
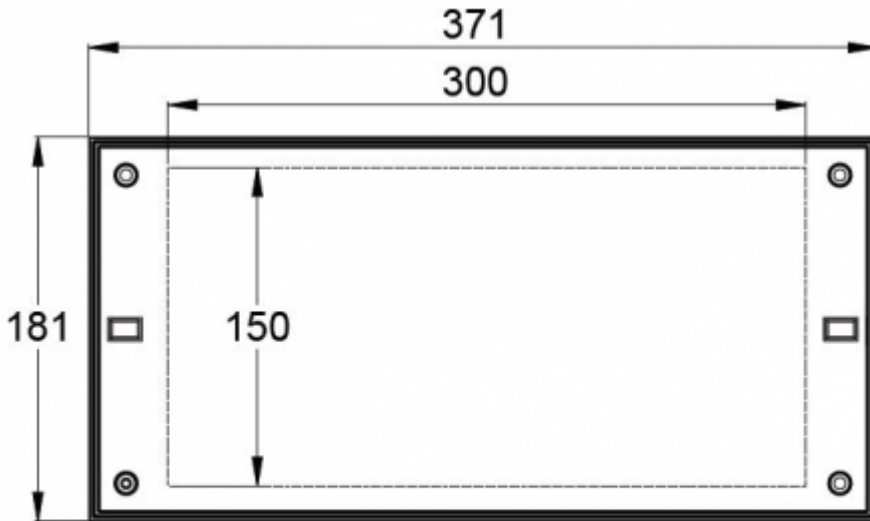

We reserve the rights to make modifications without notice.
 Copyright © 2021 Teknoware. All rights reserved.
 Date: February 15, 2021 | Source:
www.teknoware.com/en/emergency-lighting/solid-line-lowbay-led-emergency-light-twt4251-wk



SOLID LINE LOWBAY LED EMERGENCY LIGHT TWT4252WA

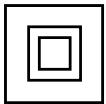
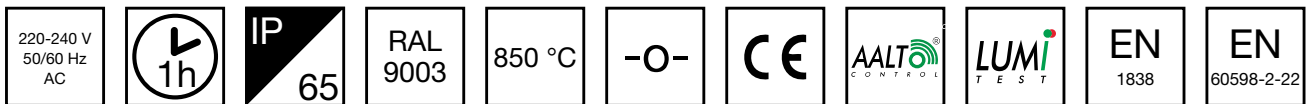

Self-contained 1 h Battery, Aalto Control compatible, LED emergency light

SOLID Line Lowbay are designed for escape route emergency lighting. The luminaire is completely dust proof and water proof, so for example it is suitable for industrial premises and parking halls. ESCAP and centrally supplied luminaires are also suitable for outdoor use.

The SOLID luminaire uses long lasting leds as its light source.

Special attention has been paid to the design, for easy installation.

INDIVIDUALLY PACKED LIGHTS

The product codes starting with letter Y include an individually packed luminaire. The product codes starting with TW include the luminaire only.

Product Code	IP Class	Luminous Flux (lm)
Y4252WA	IP65	220

Product Code	TWT4252WA
Feature	Aalto Control, Lumi Test
Mounting (standard)	surface
Customs Code	94056080
GTIN Code	6438045021386
ETIM Product Class	EC001957
Length	371 mm
Width	181 mm
Height	57 mm
Weight	1,1 kg
Backup	1 h
Max Input Power VA	2,6 VA
Nominal Supply Voltage	220-240 V, 50/60 Hz AC
Protection Class	II
IP Class	IP65
Temperature Range Min - Max	-0...+35 °C
Glow Wire Test of Plastic Materials	850 °C
Body Material	plastic
Colour	RAL9003
Electrical Installation	2/3 x 2,5 mm ²

We reserve the rights to make modifications without notice.

Copyright © 2021 Teknoware. All rights reserved.

Date: February 15, 2021 | Source:

www.teknoware.com/en/emergency-lighting/solid-line-lowbay-led-emergency-light-twt4252

wa



Emergency lighting for escape routes (ceiling mounting)

Table of 1 lux for escape routes in the middle line according to the norm EN 1838.

Level of measurement 0,02 m, measurement result with battery operation.

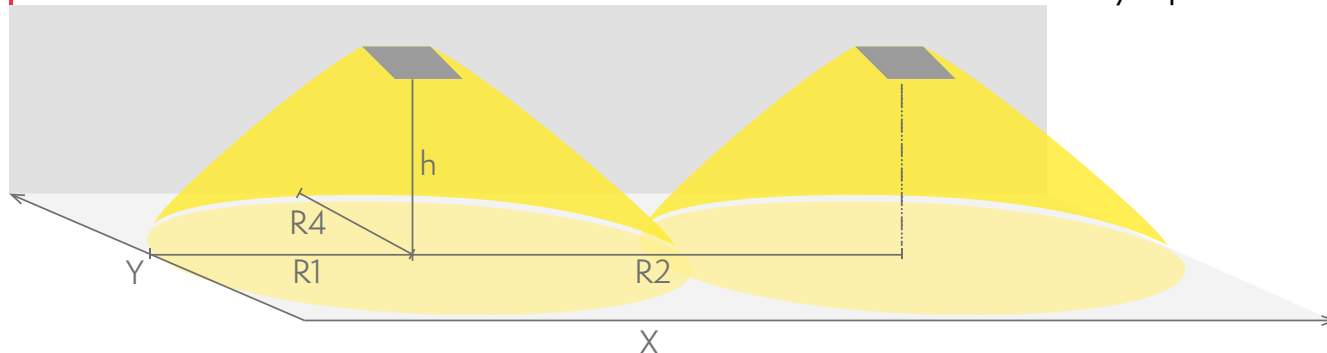

R1 distance from wall (X axis)

R2 installation distance between lights (X axis)

R4 distance from wall (Y axis)

TWT4252WA

Mounting height (m)	Below the light lux	R1 (m)	R2 (m)	R4 (m)
		1 lux	1 lux	1 lux
2,5	8	8	19	1
3	5,5	9	21	1
4	3	10	25	1

OPTIONAL ACCESSORIES:

OPTIONAL MOUNTING ACCESSORIES FOR EMERGENCY EXIT LIGHTS



Product Code	Product Name	Compatible Product Groups
TWT3006	Solid Suspension Bracket TWT3006	Solid Exit 2 Emergency Exit Lights, Solid: Line Lowbay Emergency Lights, Solid: Line Midbay Emergency Lights, Solid: Zone Lowbay Emergency Lights, Solid: Zone Midbay Emergency Lights

We reserve the rights to make modifications without notice.

Copyright © 2021 Teknoware. All rights reserved.

Date: February 15, 2021 | Source:

www.teknoware.com/en/emergency-lighting/solid-line-lowbay-led-emergency-light-twt4252

wa



COMPATIBLE PRODUCTS:

OPTIONAL MOUNTING ACCESSORIES FOR EMERGENCY EXIT LIGHTS



Product Code	Product Name	Compatible Product Groups
TWT3001	Solid Recess Mounting Frame TWT3001	Solid Exit Emergency Exit Lights, Solid Exit 2 Emergency Exit Lights, Solid: Line Lowbay Emergency Lights, Solid: Line Midbay Emergency Lights, Solid: Zone Lowbay Emergency Lights, Solid: Zone Midbay Emergency Lights
TWT3002	Solid Wall bracket TWT3002	Solid Exit Emergency Exit Lights, Solid Exit 2 Emergency Exit Lights, Solid: Line Lowbay Emergency Lights, Solid: Line Midbay Emergency Lights, Solid: Zone Lowbay Emergency Lights, Solid: Zone Midbay Emergency Lights
TWT3003	Solid Flag bracket TWT3003	Solid Exit Emergency Exit Lights, Solid Exit 2 Emergency Exit Lights, Solid: Line Lowbay Emergency Lights, Solid: Line Midbay Emergency Lights, Solid: Zone Lowbay Emergency Lights, Solid: Zone Midbay Emergency Lights
TWT3004	Solid Ceiling bracket TWT3004	Solid Exit Emergency Exit Lights, Solid Exit 2 Emergency Exit Lights, Solid: Line Lowbay Emergency Lights, Solid: Line Midbay Emergency Lights, Solid: Zone Lowbay Emergency Lights, Solid: Zone Midbay Emergency Lights

We reserve the rights to make modifications without notice.

Copyright © 2021 Teknoware. All rights reserved.

Date: February 15, 2021 | Source:

www.teknoware.com/en/emergency-lighting/solid-line-lowbay-led-emergency-light-twt4252

wa



Teknoware Oy | P.O. Box 19, 15101 Lahti | Ilmarisentie 8, 15200 Lahti Finland

Tel +358 3 883 020 | VAT-number FI01494751 | teknoware.com | emexit@teknoware.com



We reserve the rights to make modifications without notice.
Copyright © 2021 Teknoware. All rights reserved.
Date: February 15, 2021 | Source:
www.teknoware.com/en/emergency-lighting/solid-line-lowbay-led-emergency-light-twt4252wa

Teknoware Oy | P.O. Box 19, 15101 Lahti | Ilmarisentie 8, 15200 Lahti Finland
Tel +358 3 883 020 | VAT-number FI01494751 | teknoware.com | emexit@teknoware.com



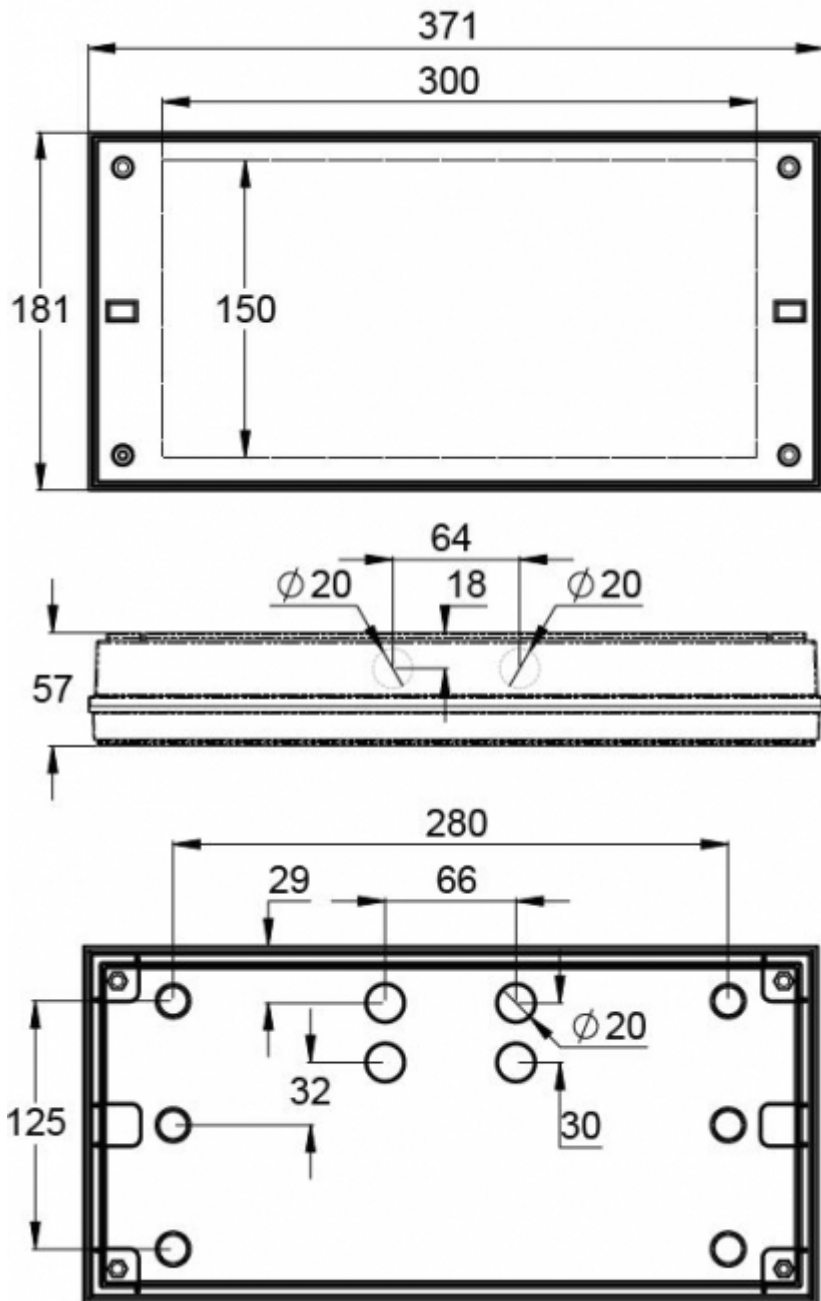

We reserve the rights to make modifications without notice.
 Copyright © 2021 Teknoware. All rights reserved.
 Date: February 15, 2021 | Source:
www.teknoware.com/en/emergency-lighting/solid-line-lowbay-led-emergency-light-twt4252wa



Teknoware Oy | P.O. Box 19, 15101 Lahti | Ilmarisentie 8, 15200 Lahti Finland
 Tel +358 3 883 020 | VAT-number FI01494751 | teknoware.com | emexit@teknoware.com

SOLID LINE LOWBAY LED EMERGENCY LIGHT TWT4252WM

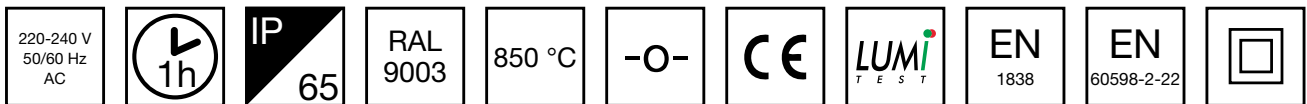

Self-contained 1 h Battery with Lumi Test Self-testing, LED emergency light

SOLID Line Lowbay are designed for escape route emergency lighting. The luminaire is completely dust proof and water proof, so for example it is suitable for industrial premises and parking halls. ESCAP and centrally supplied luminaires are also suitable for outdoor use.

The SOLID luminaire uses long lasting leds as its light source.

Special attention has been paid to the design, for easy installation.

INDIVIDUALLY PACKED LIGHTS

The product codes starting with letter Y include an individually packed luminaire. The product codes starting with TW include the luminaire only.

Product Code	IP Class	Luminous Flux (lm)
Y4252WM	IP65	220

Product Code	TWT4252WM
Feature	Lumi Test
Mounting (standard)	surface
Customs Code	94056080
GTIN Code	6438045021461
ETIM Product Class	EC001957
Length	371 mm
Width	181 mm
Height	57 mm
Weight	1,1 kg
Backup	1 h
Max Input Power VA	2,1 VA
Nominal Supply Voltage	220-240 V, 50/60 Hz AC
Protection Class	II
IP Class	IP65
Temperature Range Min - Max	-0...+35 °C
Glow Wire Test of Plastic Materials	850 °C
Body Material	plastic
Colour	RAL9003
Electrical Installation	2/3 x 2,5 mm ²

We reserve the rights to make modifications without notice.

Copyright © 2021 Teknoware. All rights reserved.

Date: February 15, 2021 | Source:

www.teknoware.com/en/emergency-lighting/solid-line-lowbay-led-emergency-light-twt4252

wm



Emergency lighting for escape routes (ceiling mounting)

Table of 1 lux for escape routes in the middle line according to the norm EN 1838.

Level of measurement 0,02 m, measurement result with battery operation.

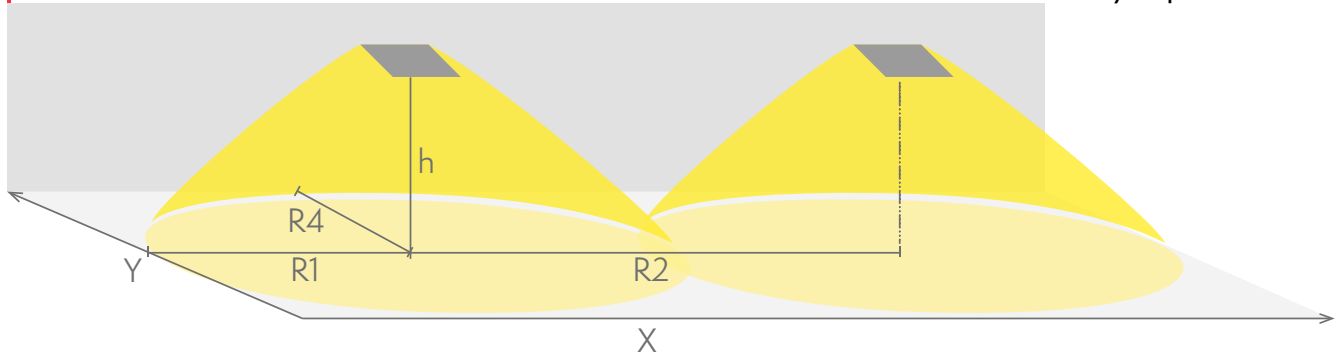

R1 distance from wall (X axis)

R2 installation distance between lights (X axis)

R4 distance from wall (Y axis)

TWT4252WM

Mounting height (m)	Below the light lux	R1 (m)	R2 (m)	R4 (m)
		1 lux	1 lux	1 lux
2,5	8	8	19	1
3	5,5	9	21	1
4	3	10	25	1

OPTIONAL ACCESSORIES:

OPTIONAL MOUNTING ACCESSORIES FOR EMERGENCY EXIT LIGHTS



Product Code	Product Name	Compatible Product Groups
TWT3006	Solid Suspension Bracket TWT3006	Solid Exit 2 Emergency Exit Lights, Solid: Line Lowbay Emergency Lights, Solid: Line Midbay Emergency Lights, Solid: Zone Lowbay Emergency Lights, Solid: Zone Midbay Emergency Lights

We reserve the rights to make modifications without notice.

Copyright © 2021 Teknoware. All rights reserved.

Date: February 15, 2021 | Source:

www.teknoware.com/en/emergency-lighting/solid-line-lowbay-led-emergency-light-twt4252wm

wm

 **TEKNOWARE**[®]

Teknoware Oy | P.O. Box 19, 15101 Lahti | Ilmarisentie 8, 15200 Lahti Finland

Tel +358 3 883 020 | VAT-number FI01494751 | teknoware.com | emexit@teknoware.com

COMPATIBLE PRODUCTS:

OPTIONAL MOUNTING ACCESSORIES FOR EMERGENCY EXIT LIGHTS



Product Code	Product Name	Compatible Product Groups
TWT3001	Solid Recess Mounting Frame TWT3001	Solid Exit Emergency Exit Lights, Solid Exit 2 Emergency Exit Lights, Solid: Line Lowbay Emergency Lights, Solid: Line Midbay Emergency Lights, Solid: Zone Lowbay Emergency Lights, Solid: Zone Midbay Emergency Lights
TWT3002	Solid Wall bracket TWT3002	Solid Exit Emergency Exit Lights, Solid Exit 2 Emergency Exit Lights, Solid: Line Lowbay Emergency Lights, Solid: Line Midbay Emergency Lights, Solid: Zone Lowbay Emergency Lights, Solid: Zone Midbay Emergency Lights
TWT3003	Solid Flag bracket TWT3003	Solid Exit Emergency Exit Lights, Solid Exit 2 Emergency Exit Lights, Solid: Line Lowbay Emergency Lights, Solid: Line Midbay Emergency Lights, Solid: Zone Lowbay Emergency Lights, Solid: Zone Midbay Emergency Lights
TWT3004	Solid Ceiling bracket TWT3004	Solid Exit Emergency Exit Lights, Solid Exit 2 Emergency Exit Lights, Solid: Line Lowbay Emergency Lights, Solid: Line Midbay Emergency Lights, Solid: Zone Lowbay Emergency Lights, Solid: Zone Midbay Emergency Lights

We reserve the rights to make modifications without notice.

Copyright © 2021 Teknoware. All rights reserved.

Date: February 15, 2021 | Source:

www.teknoware.com/en/emergency-lighting/solid-line-lowbay-led-emergency-light-twt4252wm



Teknoware Oy | P.O. Box 19, 15101 Lahti | Ilmarisentie 8, 15200 Lahti Finland

Tel +358 3 883 020 | VAT-number FI01494751 | teknoware.com | emexit@teknoware.com



We reserve the rights to make modifications without notice.
Copyright © 2021 Teknoware. All rights reserved.
Date: February 15, 2021 | Source:
www.teknoware.com/en/emergency-lighting/solid-line-lowbay-led-emergency-light-twt4252wm

Teknoware Oy | P.O. Box 19, 15101 Lahti | Ilmarisentie 8, 15200 Lahti Finland
Tel +358 3 883 020 | VAT-number FI01494751 | teknoware.com | emexit@teknoware.com



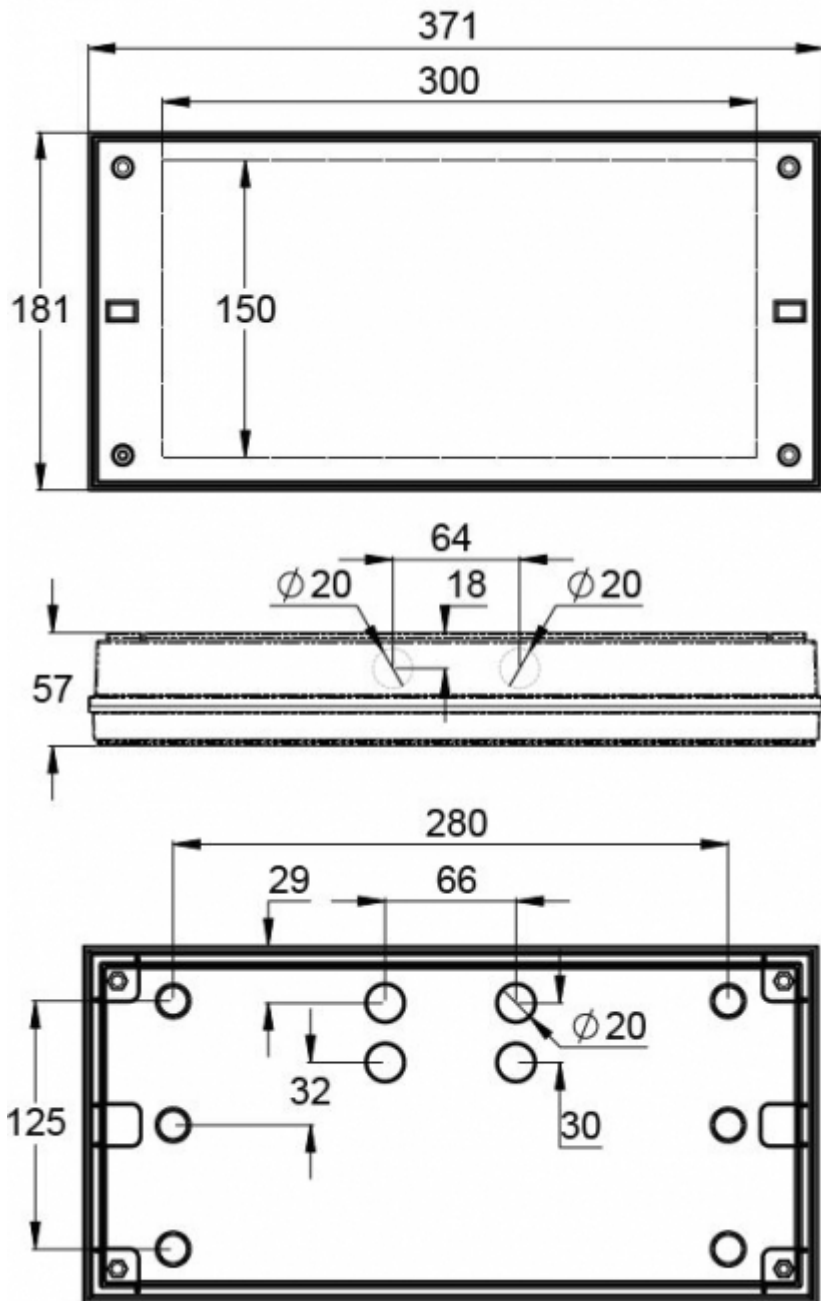

We reserve the rights to make modifications without notice.
 Copyright © 2021 Teknoware. All rights reserved.
 Date: February 15, 2021 | Source:
www.teknoware.com/en/emergency-lighting/solid-line-lowbay-led-emergency-light-twt4252-wm



Teknoware Oy | P.O. Box 19, 15101 Lahti | Ilmarisentie 8, 15200 Lahti Finland
 Tel +358 3 883 020 | VAT-number FI01494751 | teknoware.com | emexit@teknoware.com

SOLID LINE LOWBAY LED EMERGENCY LIGHT TWT4253WA

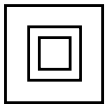
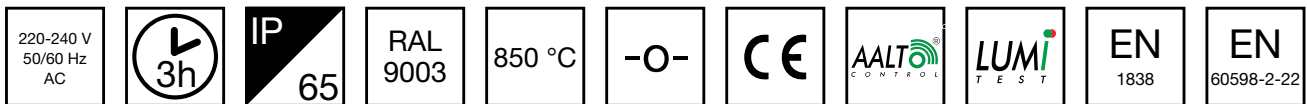

Self-contained 3 h Battery, Aalto Control compatible, LED emergency light

SOLID Line Lowbay are designed for escape route emergency lighting. The luminaire is completely dust proof and water proof, so for example it is suitable for industrial premises and parking halls. ESCAP and centrally supplied luminaires are also suitable for outdoor use.

The SOLID luminaire uses long lasting leds as its light source.

Special attention has been paid to the design, for easy installation.

INDIVIDUALLY PACKED LIGHTS

The product codes starting with letter Y include an individually packed luminaire. The product codes starting with TW include the luminaire only.

Product Code	IP Class	Luminous Flux (lm)
Y4253WA	IP65	220

Product Code	TWT4253WA
Feature	Aalto Control, Lumi Test
Mounting (standard)	surface
Customs Code	94056080
GTIN Code	6438045021423
ETIM Product Class	EC001957
Length	371 mm
Width	181 mm
Height	57 mm
Weight	1,1 kg
Backup	3 h
Max Input Power VA	3,5 VA
Nominal Supply Voltage	220-240 V, 50/60 Hz AC
Protection Class	II
IP Class	IP65
Temperature Range Min - Max	-0...+35 °C
Glow Wire Test of Plastic Materials	850 °C
Body Material	plastic
Colour	RAL9003
Electrical Installation	2/3 x 2,5 mm ²

We reserve the rights to make modifications without notice.

Copyright © 2021 Teknoware. All rights reserved.

Date: February 15, 2021 | Source:

www.teknoware.com/en/emergency-lighting/solid-line-lowbay-led-emergency-light-twt4253

wa



Emergency lighting for escape routes (ceiling mounting)

Table of 1 lux for escape routes in the middle line according to the norm EN 1838.

Level of measurement 0,02 m, measurement result with battery operation.

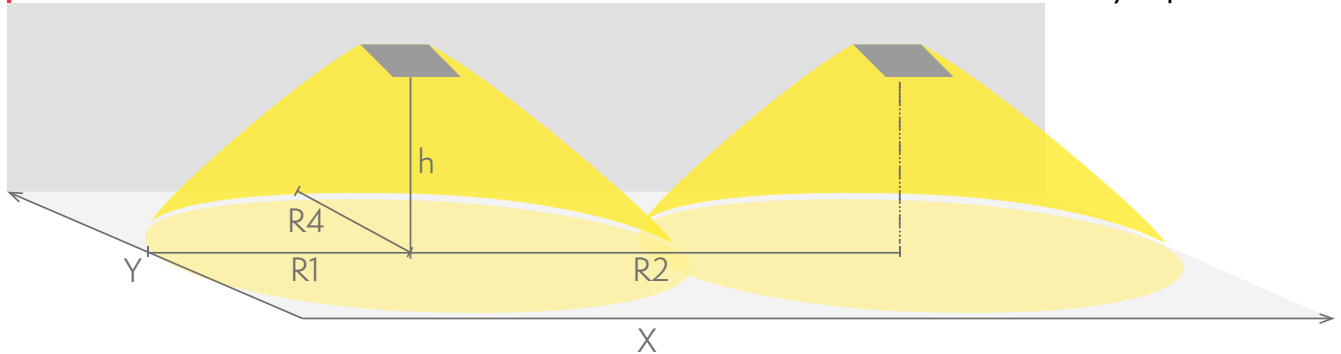

R1 distance from wall (X axis)

R2 installation distance between lights (X axis)

R4 distance from wall (Y axis)

TWT4253WA

Mounting height (m)	Below the light lux	R1 (m)	R2 (m)	R4 (m)
		1 lux	1 lux	1 lux
2,5	8	8	19	1
3	5,5	9	21	1
4	3	10	25	1

OPTIONAL ACCESSORIES:

OPTIONAL MOUNTING ACCESSORIES FOR EMERGENCY EXIT LIGHTS



Product Code	Product Name	Compatible Product Groups
TWT3006	Solid Suspension Bracket TWT3006	Solid Exit 2 Emergency Exit Lights, Solid: Line Lowbay Emergency Lights, Solid: Line Midbay Emergency Lights, Solid: Zone Lowbay Emergency Lights, Solid: Zone Midbay Emergency Lights

We reserve the rights to make modifications without notice.

Copyright © 2021 Teknoware. All rights reserved.

Date: February 15, 2021 | Source:

www.teknoware.com/en/emergency-lighting/solid-line-lowbay-led-emergency-light-twt4253

wa



COMPATIBLE PRODUCTS:

OPTIONAL MOUNTING ACCESSORIES FOR EMERGENCY EXIT LIGHTS



Product Code	Product Name	Compatible Product Groups
TWT3001	Solid Recess Mounting Frame TWT3001	Solid Exit Emergency Exit Lights, Solid Exit 2 Emergency Exit Lights, Solid: Line Lowbay Emergency Lights, Solid: Line Midbay Emergency Lights, Solid: Zone Lowbay Emergency Lights, Solid: Zone Midbay Emergency Lights
TWT3002	Solid Wall bracket TWT3002	Solid Exit Emergency Exit Lights, Solid Exit 2 Emergency Exit Lights, Solid: Line Lowbay Emergency Lights, Solid: Line Midbay Emergency Lights, Solid: Zone Lowbay Emergency Lights, Solid: Zone Midbay Emergency Lights
TWT3003	Solid Flag bracket TWT3003	Solid Exit Emergency Exit Lights, Solid Exit 2 Emergency Exit Lights, Solid: Line Lowbay Emergency Lights, Solid: Line Midbay Emergency Lights, Solid: Zone Lowbay Emergency Lights, Solid: Zone Midbay Emergency Lights
TWT3004	Solid Ceiling bracket TWT3004	Solid Exit Emergency Exit Lights, Solid Exit 2 Emergency Exit Lights, Solid: Line Lowbay Emergency Lights, Solid: Line Midbay Emergency Lights, Solid: Zone Lowbay Emergency Lights, Solid: Zone Midbay Emergency Lights

We reserve the rights to make modifications without notice.

Copyright © 2021 Teknoware. All rights reserved.

Date: February 15, 2021 | Source:

www.teknoware.com/en/emergency-lighting/solid-line-lowbay-led-emergency-light-twt4253

wa



Teknoware Oy | P.O. Box 19, 15101 Lahti | Ilmarisentie 8, 15200 Lahti Finland

Tel +358 3 883 020 | VAT-number FI01494751 | teknoware.com | emexit@teknoware.com



We reserve the rights to make modifications without notice.
Copyright © 2021 Teknoware. All rights reserved.
Date: February 15, 2021 | Source:
www.teknoware.com/en/emergency-lighting/solid-line-lowbay-led-emergency-light-twt4253wa

Teknoware Oy | P.O. Box 19, 15101 Lahti | Ilmarisentie 8, 15200 Lahti Finland
Tel +358 3 883 020 | VAT-number FI01494751 | teknoware.com | emexit@teknoware.com



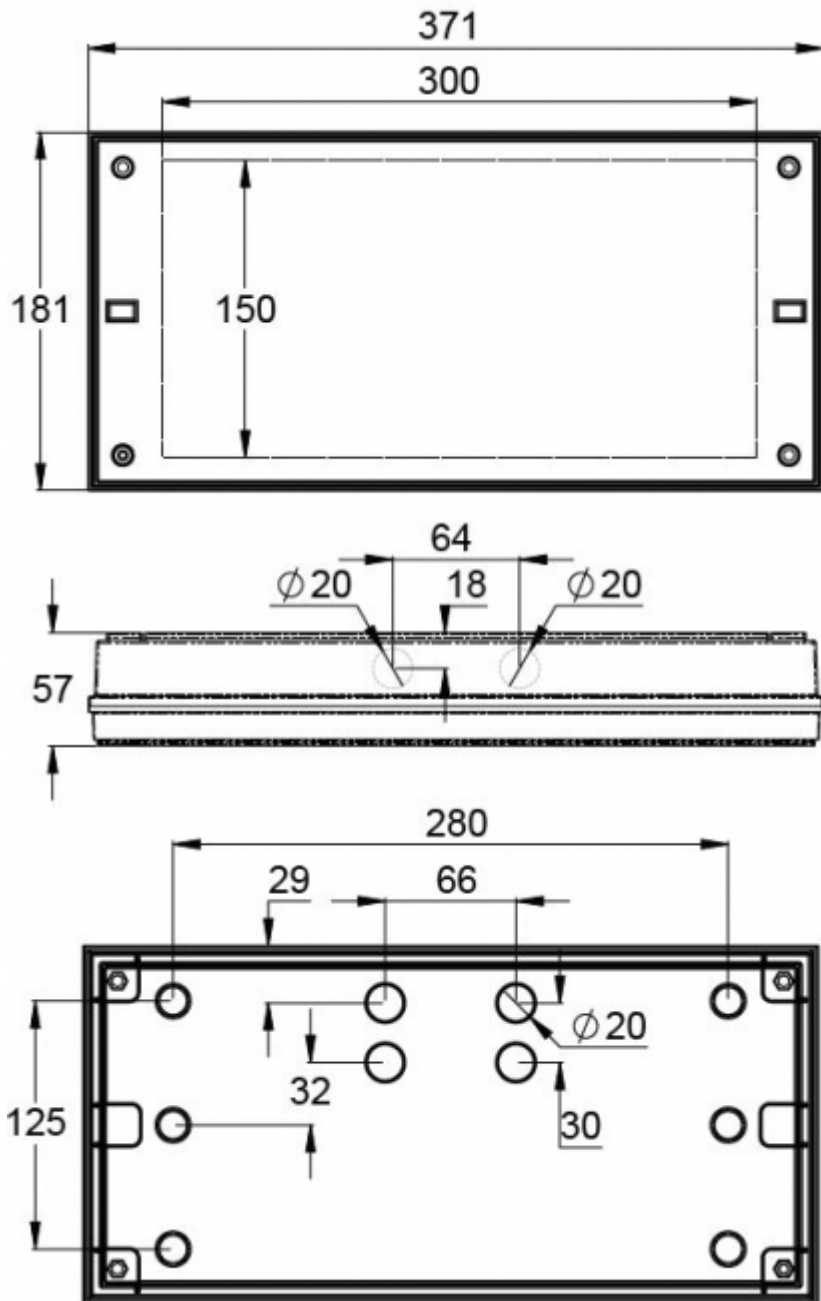

We reserve the rights to make modifications without notice.
 Copyright © 2021 Teknoware. All rights reserved.
 Date: February 15, 2021 | Source:
www.teknoware.com/en/emergency-lighting/solid-line-lowbay-led-emergency-light-twt4253
 wa



Teknoware Oy | P.O. Box 19, 15101 Lahti | Ilmarisentie 8, 15200 Lahti Finland
 Tel +358 3 883 020 | VAT-number FI01494751 | teknoware.com | emexit@teknoware.com

SOLID LINE LOWBAY LED EMERGENCY LIGHT TWT4253WM

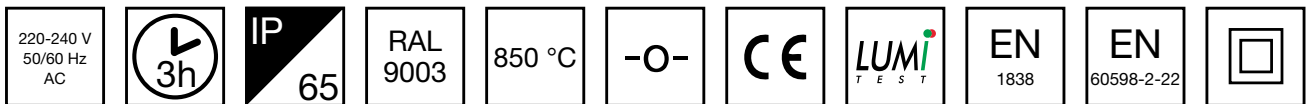

Self-contained 3 h Battery with Lumi Test Self-testing, LED emergency light

SOLID Line Lowbay are designed for escape route emergency lighting. The luminaire is completely dust proof and water proof, so for example it is suitable for industrial premises and parking halls. ESCAP and centrally supplied luminaires are also suitable for outdoor use.

The SOLID luminaire uses long lasting leds as its light source.

Special attention has been paid to the design, for easy installation.

INDIVIDUALLY PACKED LIGHTS

The product codes starting with letter Y include an individually packed luminaire. The product codes starting with TW include the luminaire only.

Product Code	IP Class	Luminous Flux (lm)
Y4253WM	IP65	220

Product Code	TWT4253WM
Feature	Lumi Test
Mounting (standard)	surface
Customs Code	94056080
GTIN Code	6438045021508
ETIM Product Class	EC001957
Length	371 mm
Width	181 mm
Height	57 mm
Weight	1,1 kg
Backup	3 h
Max Input Power VA	3,3 VA
Nominal Supply Voltage	220-240 V, 50/60 Hz AC
Protection Class	II
IP Class	IP65
Temperature Range Min - Max	-0...+35 °C
Glow Wire Test of Plastic Materials	850 °C
Body Material	plastic
Colour	RAL9003
Electrical Installation	2/3 x 2,5 mm ²

We reserve the rights to make modifications without notice.

Copyright © 2021 Teknoware. All rights reserved.

Date: February 15, 2021 | Source:

www.teknoware.com/en/emergency-lighting/solid-line-lowbay-led-emergency-light-twt4253

wm



Emergency lighting for escape routes (ceiling mounting)

Table of 1 lux for escape routes in the middle line according to the norm EN 1838.

Level of measurement 0,02 m, measurement result with battery operation.

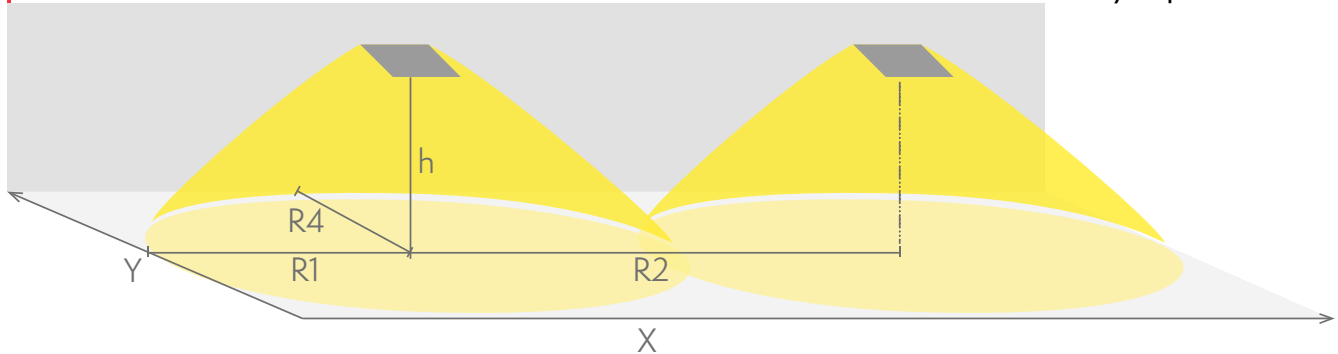

R1 distance from wall (X axis)

R2 installation distance between lights (X axis)

R4 distance from wall (Y axis)

TWT4253WM

Mounting height (m)	Below the light lux	R1 (m)	R2 (m)	R4 (m)
		1 lux	1 lux	1 lux
2,5	8	8	19	1
3	5,5	9	21	1
4	3	10	25	1

OPTIONAL ACCESSORIES:

OPTIONAL MOUNTING ACCESSORIES FOR EMERGENCY EXIT LIGHTS



Product Code	Product Name	Compatible Product Groups
TWT3006	Solid Suspension Bracket TWT3006	Solid Exit 2 Emergency Exit Lights, Solid: Line Lowbay Emergency Lights, Solid: Line Midbay Emergency Lights, Solid: Zone Lowbay Emergency Lights, Solid: Zone Midbay Emergency Lights

We reserve the rights to make modifications without notice.

Copyright © 2021 Teknoware. All rights reserved.

Date: February 15, 2021 | Source:

www.teknoware.com/en/emergency-lighting/solid-line-lowbay-led-emergency-light-twt4253wm

wm

 **TEKNOWARE**[®]

Teknoware Oy | P.O. Box 19, 15101 Lahti | Ilmarisentie 8, 15200 Lahti Finland

Tel +358 3 883 020 | VAT-number FI01494751 | teknoware.com | emexit@teknoware.com

COMPATIBLE PRODUCTS:

OPTIONAL MOUNTING ACCESSORIES FOR EMERGENCY EXIT LIGHTS



Product Code	Product Name	Compatible Product Groups
TWT3001	Solid Recess Mounting Frame TWT3001	Solid Exit Emergency Exit Lights, Solid Exit 2 Emergency Exit Lights, Solid: Line Lowbay Emergency Lights, Solid: Line Midbay Emergency Lights, Solid: Zone Lowbay Emergency Lights, Solid: Zone Midbay Emergency Lights
TWT3002	Solid Wall bracket TWT3002	Solid Exit Emergency Exit Lights, Solid Exit 2 Emergency Exit Lights, Solid: Line Lowbay Emergency Lights, Solid: Line Midbay Emergency Lights, Solid: Zone Lowbay Emergency Lights, Solid: Zone Midbay Emergency Lights
TWT3003	Solid Flag bracket TWT3003	Solid Exit Emergency Exit Lights, Solid Exit 2 Emergency Exit Lights, Solid: Line Lowbay Emergency Lights, Solid: Line Midbay Emergency Lights, Solid: Zone Lowbay Emergency Lights, Solid: Zone Midbay Emergency Lights
TWT3004	Solid Ceiling bracket TWT3004	Solid Exit Emergency Exit Lights, Solid Exit 2 Emergency Exit Lights, Solid: Line Lowbay Emergency Lights, Solid: Line Midbay Emergency Lights, Solid: Zone Lowbay Emergency Lights, Solid: Zone Midbay Emergency Lights

We reserve the rights to make modifications without notice.

Copyright © 2021 Teknoware. All rights reserved.

Date: February 15, 2021 | Source:

www.teknoware.com/en/emergency-lighting/solid-line-lowbay-led-emergency-light-twt4253

wm



Teknoware Oy | P.O. Box 19, 15101 Lahti | Ilmarisentie 8, 15200 Lahti Finland

Tel +358 3 883 020 | VAT-number FI01494751 | teknoware.com | emexit@teknoware.com



We reserve the rights to make modifications without notice.
Copyright © 2021 Teknoware. All rights reserved.
Date: February 15, 2021 | Source:
www.teknoware.com/en/emergency-lighting/solid-line-lowbay-led-emergency-light-twt4253wm

Teknoware Oy | P.O. Box 19, 15101 Lahti | Ilmarisentie 8, 15200 Lahti Finland
Tel +358 3 883 020 | VAT-number FI01494751 | teknoware.com | emexit@teknoware.com



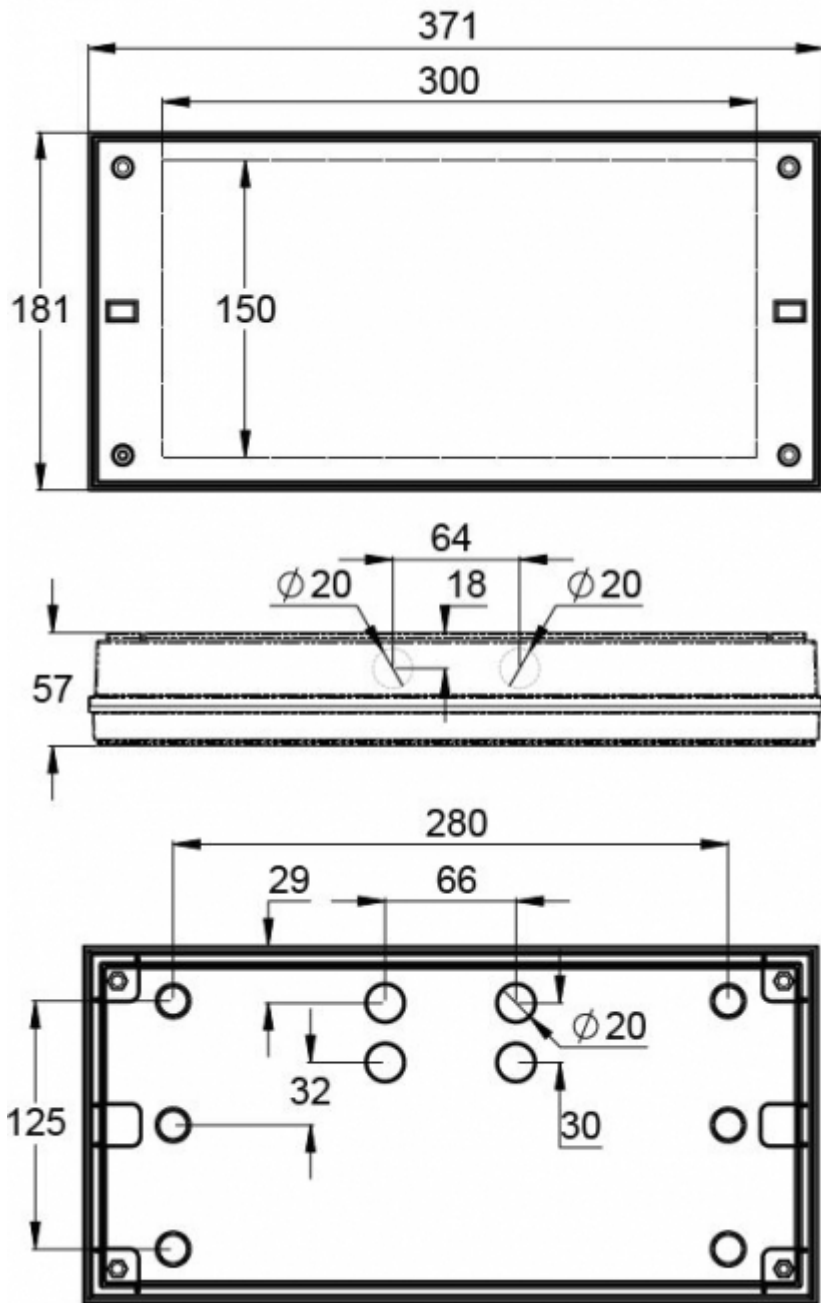

We reserve the rights to make modifications without notice.
 Copyright © 2021 Teknoware. All rights reserved.
 Date: February 15, 2021 | Source:
www.teknoware.com/en/emergency-lighting/solid-line-lowbay-led-emergency-light-twt4253-wm



Teknoware Oy | P.O. Box 19, 15101 Lahti | Ilmarisentie 8, 15200 Lahti Finland
 Tel +358 3 883 020 | VAT-number FI01494751 | teknoware.com | emexit@teknoware.com

SOLID LINE LOWBAY LED EMERGENCY LIGHT TWT4271W

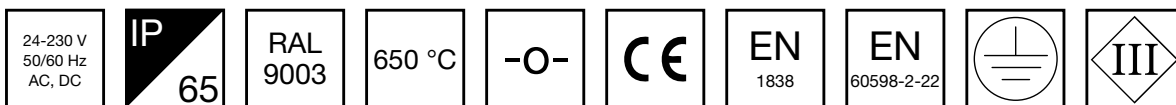

24-230 V centrally supplied LED emergency light for escape routes

SOLID Line Lowbay are designed for escape route emergency lighting. The luminaire is completely dust proof and water proof, so for example it is suitable for industrial premises and parking halls. ESCAP and centrally supplied luminaires are also suitable for outdoor use.

The SOLID luminaire uses long lasting leds as its light source.

Special attention has been paid to the design, for easy installation.

INDIVIDUALLY PACKED LIGHTS

The product codes starting with letter Y include an individually packed luminaire. The product codes starting with TW include the luminaire only.

Product Code	IP Class	Luminous Flux (lm)
Y4271W	IP65	220

Product Code	TWT4271W
Mounting (standard)	surface
Customs Code	94056080
GTIN Code	6438045021348
ETIM Product Class	EC001957
Length	371 mm
Width	181 mm
Height	57 mm
Weight	1,1 kg
Max Input Power VA	7,8 VA (24 V), 14,5 VA (230 V)
Max Input Power W	5,5 W (24 V), 6,5 W (230 V)
Nominal Supply Voltage	24-230 V, 50/60 Hz AC, DC
Protection Class	III(24V),II(230V)
IP Class	IP65
Temperature Range Min - Max	-30...+50 °C
Glow Wire Test of Plastic Materials	650 °C
Body Material	plastic
Colour	RAL9003
Electrical Installation	2 x 2,5 mm ² (24 V), 3 x 2,5 mm ² (230 V)
Luminous Flux	220 lm

We reserve the rights to make modifications without notice.

Copyright © 2021 Teknoware. All rights reserved.

Date: February 15, 2021 | Source:

www.teknoware.com/en/emergency-lighting/solid-line-lowbay-led-emergency-light-twt4271w

w



Emergency lighting for escape routes (ceiling mounting)

Table of 1 lux for escape routes in the middle line according to the norm EN 1838.

Level of measurement 0,02 m, measurement result with battery operation.

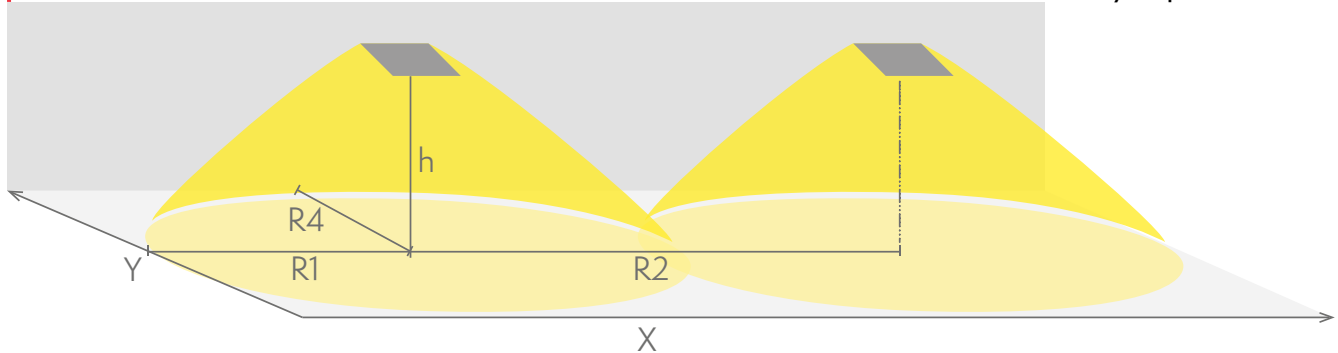

R1 distance from wall (X axis)

R2 installation distance between lights (X axis)

R4 distance from wall (Y axis)

TWT4271W

Mounting height (m)	Below the light lux	R1 (m)	R2 (m)	R4 (m)
		1 lux	1 lux	1 lux
2,5	8	8	19	1
3	5,5	9	21	1
4	3	10	25	1

OPTIONAL ACCESSORIES:

OPTIONAL MOUNTING ACCESSORIES FOR EMERGENCY EXIT LIGHTS



Product Code	Product Name	Compatible Product Groups
TWT3006	Solid Suspension Bracket TWT3006	Solid Exit 2 Emergency Exit Lights, Solid: Line Lowbay Emergency Lights, Solid: Line Midbay Emergency Lights, Solid: Zone Lowbay Emergency Lights, Solid: Zone Midbay Emergency Lights

COMPATIBLE PRODUCTS:

OPTIONAL MOUNTING ACCESSORIES FOR



We reserve the rights to make modifications without notice.

Copyright © 2021 Teknoware. All rights reserved.

Date: February 15, 2021 | Source:

www.teknoware.com/en/emergency-lighting/solid-line-lowbay-led-emergency-light-twt4271w

w



EMERGENCY EXIT LIGHTS

Product Code	Product Name	Compatible Product Groups
TWT3001	Solid Recess Mounting Frame TWT3001	Solid Exit Emergency Exit Lights, Solid Exit 2 Emergency Exit Lights, Solid: Line Lowbay Emergency Lights, Solid: Line Midbay Emergency Lights, Solid: Zone Lowbay Emergency Lights, Solid: Zone Midbay Emergency Lights
TWT3002	Solid Wall bracket TWT3002	Solid Exit Emergency Exit Lights, Solid Exit 2 Emergency Exit Lights, Solid: Line Lowbay Emergency Lights, Solid: Line Midbay Emergency Lights, Solid: Zone Lowbay Emergency Lights, Solid: Zone Midbay Emergency Lights
TWT3003	Solid Flag bracket TWT3003	Solid Exit Emergency Exit Lights, Solid Exit 2 Emergency Exit Lights, Solid: Line Lowbay Emergency Lights, Solid: Line Midbay Emergency Lights, Solid: Zone Lowbay Emergency Lights, Solid: Zone Midbay Emergency Lights
TWT3004	Solid Ceiling bracket TWT3004	Solid Exit Emergency Exit Lights, Solid Exit 2 Emergency Exit Lights, Solid: Line Lowbay Emergency Lights, Solid: Line Midbay Emergency Lights, Solid: Zone Lowbay Emergency Lights, Solid: Zone Midbay Emergency Lights

We reserve the rights to make modifications without notice.

Copyright © 2021 Teknoware. All rights reserved.

Date: February 15, 2021 | Source:

www.teknoware.com/en/emergency-lighting/solid-line-lowbay-led-emergency-light-twt4271

w

Teknoware Oy | P.O. Box 19, 15101 Lahti | Ilmarisentie 8, 15200 Lahti Finland

Tel +358 3 883 020 | VAT-number FI01494751 | teknoware.com | emexit@teknoware.com



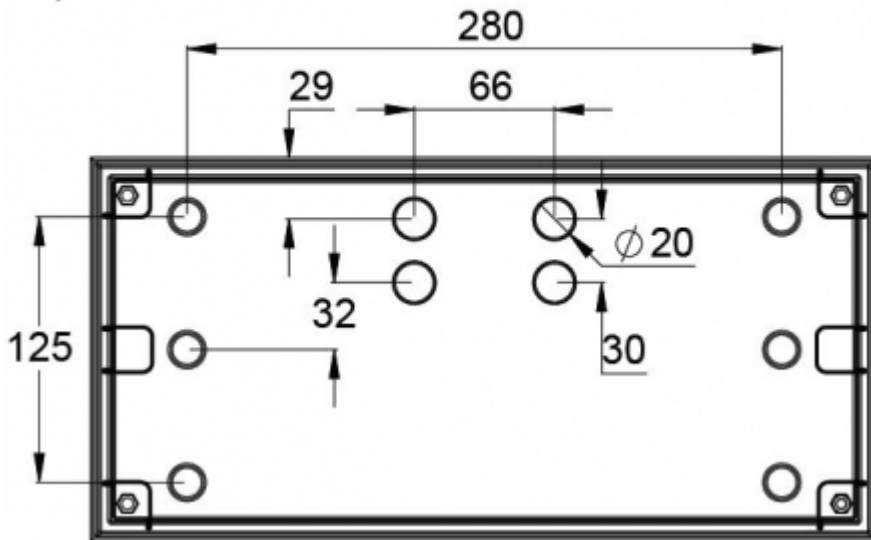
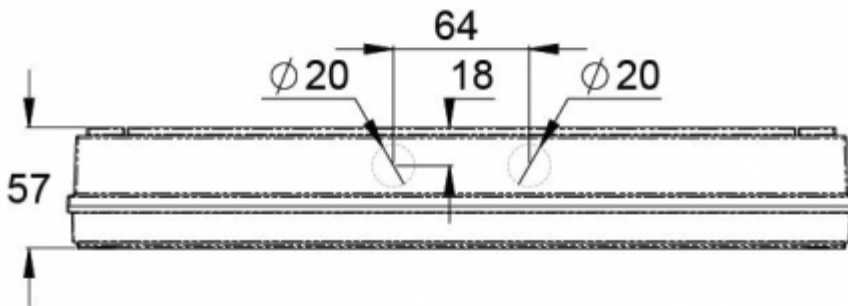
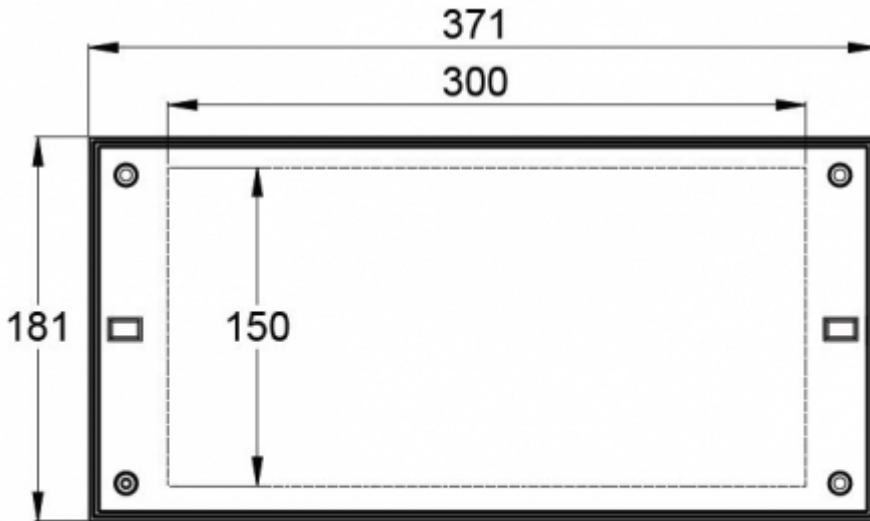

We reserve the rights to make modifications without notice.
 Copyright © 2021 Teknoware. All rights reserved.
 Date: February 15, 2021 | Source:
www.teknoware.com/en/emergency-lighting/solid-line-lowbay-led-emergency-light-twt4271w

