

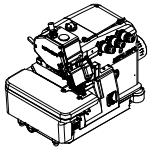









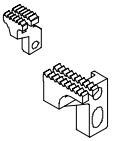











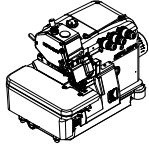

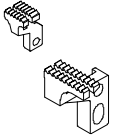







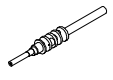
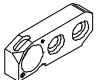

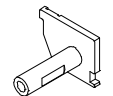

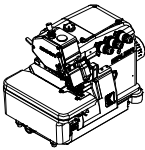

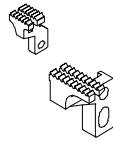



SIRUBA GAGE PARTS LIST		Series					Remark									Page	Date
		700L														1 / 3	2020/07/22
																	
機 型 MODEL		針板 NEEDLE PLATE	送 具 FEED DOG		送具 FEED DOG	押 具 PRESSER FOOT	勾 針 LOOPER	針留 NEEDLE CLAMP	束 子 COLLER	衝 程 CRANK	衝 程 CRANK	大 心 Crankshaft	勾針連桿座 Upper Looper Holder	過線器 Bracket	下刀架 Lower Knife Holder	針 號 NEEDLE	
737L	503M-3-04	E268	D210K	D207	H204K	P220-A1	LP231	KG231K-E	KJ247-E	KF203-E	KJ206-E	KD201J	KJ236K	KJ219	KR209	DCX27#11	
	504F-2-04	E250	D201K	D207	H201K	P201-14A	LP225	KG231K-E	KJ247-E	KF203-E	KJ206-E	KD201J	KJ236K	KJ219	KR209	DCX27#9	
	504F-2-15	E275	D201K	D217	H201K	P214P-A	LP225	KG231K-E	KJ247-E	KF203-E	KJ206-E	KD201J	KJ236K	KJ219	KR209	DCX27#9	
	504F-2-02/GAL	E233K	D201K	D217	H201K	P214P-2A	LP225	KG231K-E	KJ247-E	KF203-E	KJ206-E	KD201J	KJ236K	KJ219	KR209	DCX27#9	
	504M-2-15	E207K	D201K	D209	H201K	P211-A	LP225	KG231K-E	KJ247-E	KF203-E	KJ206-E	KD201J	KJ236K	KJ219	KR209	DCX27#9	
	504M-3-04	E268	D210K	D207	H204K	P220-A1	LP225	KG231K-E	KJ247-E	KF203-E	KJ206-E	KD201J	KJ236K	KJ219	KR209	DCX27#11	
	504M-3-04/LFC-3	E268	D210K	D207	H204K	P216-3	LP225	KG231K-E	KJ247-E	KF203-E	KJ206-E	KD201J	KJ236K	KJ219	KR209	DCX27#11	
	504M-3-04/TR	E268	D210K	D207	H204K	P216-3	LP225	KG231K-E	KJ247-E	KF203-E	KJ206-E	KD201J	KJ236K	KJ219	KR209	DCX27#11	
	504M-3-04/ECA-U	E222U	D210K	D207	H204K	P201-14A1	LP225	KG231K-E	KJ247-E	KF203-E	KJ206-E	KD201J	KJ236K	KJ219	KR209	DCX27#11	
	504M-3-04/ECB-U	E222U	D210K	D207	H204K	P201-14A1	LP225	KG231K-E	KJ247-E	KF203-E	KJ206-E	KD201J	KJ236K	KJ219	KR209	DCX27#11	
	504M-3-04/VTE-U	E222U	D210K	D207	H204K	P201-14A1	LP225	KG231K-E	KJ247-E	KF203-E	KJ206-E	KD201J	KJ236K	KJ219	KR209	DCX27#11	
	WR/LFC-3	E246						LP225	KG231K-E	KJ247-E	KF203-E	KJ206-E	KD201J	KJ236K	KJ219	DCX27#11	
	504M-3-05	E274	D210K	D207	H204K	P220-A1	LP225	KG231K-E	KJ247-E	KF203-E	KJ206-E	KD201J	KJ236K	KJ219	KR209	DCX27#11	
	504M-3-05/PZ	E274	D210K	D207	H204K	P257-A	LP225	KG231K-E	KJ247-E	KF203-E	KJ206-E	KD201J	KJ236K	KJ219	KR209	DCX27#18	
	504M-7-04/BK	E232	D203K	D207	H203K	P202-2A	LP225	KG231K-E	KJ247-E	KF203-E	KJ206-E	KD201J	KJ236K	KJ219	KR209	DCX27#11	
504M-7-04/BK-1	E232	D203K	D207	H203K	P202-2A	LP225	KG231K-E	KJ247-E	KF203-E	KJ206-E	KD201J	KJ236K	KJ219	BK239	DCX27#11		
505F-2-04	E250	D201K	D207	H201K	P203-A	LP225	KG231K-E	KJ247-E	KF203-E	KJ206-E	KD201J	KJ236K	KJ219	KR209	DCX27#9		
747L	512M-3-25	E276	D210K	D207	H204K	P220-A2	LP228	KG242K-E	KJ247-E	KF215-E	KJ203-E	KD201J	KJ208K	KJ219	KR209	DCX27#11*2	
	512M-3-34	E236	D210K	D207	H204K	P214-A	LP228	KG254K-E	KJ247-E	KF215-E	KJ203-E	KD201J	KJ228K	KJ219	KR209	DCX27#14*2	
	514M-8-24/GA	E252	D202K	D207	H202K	P204-A	LP226	KG242K-E	KJ246-E	KF203-E	KJ203-E	KD201J	KJ208K	KJ219	KR209	DCX27#11*2	
	514M-8-24/GA/P	E252	D202K	D207	H202K	P204P-A	LP226	KG242K-E	KJ246-E	KF203-E	KJ203-E	KD201J	KJ208K	KJ219	KR209	DCX27#11*2	
	514M-3-24	E252	D210K	D207	H204K	P220-A2	LP226	KG242K-E	KJ246-E	KF203-E	KJ203-E	KD201J	KJ208K	KJ219	KR209	DCX27#11*2	
	514M-3-24/TG	E252	D210K	D207	H204K	P226-A	LP226	KG242K-E	KJ246-E	KF203-E	KJ203-E	KD201J	KJ208K	KJ219	KR209	DCX27#11*2	
	514M-3-24/LFC-3	E252	D210K	D207	H204K	P216-4	LP226	KG242K-E	KJ246-E	KF203-E	KJ203-E	KD201J	KJ208K	KJ219	KR209	DCX27#11*2	
	514M-3-24/ECA-U	E229U	D210K	D207	H204K	P201U-A1	LP226	KG242K-E	KJ246-E	KF203-E	KJ203-E	KD201J	KJ208K	KJ219	KR209	DCX27#11*2	
	514M-3-24/ECB-U	E229U	D210K	D207	H204K	P201U-A1	LP226	KG242K-E	KJ246-E	KF203-E	KJ203-E	KD201J	KJ208K	KJ219	KR209	DCX27#11*2	
	514M-3-24/VTE-U	E229U	D210K	D207	H204K	P201U-A1	LP226	KG242K-E	KJ246-E	KF203-E	KJ203-E	KD201J	KJ208K	KJ219	KR209	DCX27#11*2	
514M-3-25	E276	D210K	D207	H204K	P220-A2	LP226	KG242K-E	KJ246-E	KF203-E	KJ203-E	KD201J	KJ208K	KJ219	KR209	DCX27#11*2		

SIRUBA GAGE PARTS LIST		Series					Remark								Page	Date
		700L													2 / 3	2020/07/22
																
機 型 MODEL		針板 NEEDLE PLATE	送 具 FEED DOG	送 具 FEED DOG	押 具 PRESSER FOOT	勾 針 LOOPER	針留 NEEDLE CLAMP	束 子 COLLER	衝 程 CRANK	衝 程 CRANK	大 心 Crankshaft	勾針連桿座 Upper Looper Holder	過線器 Bracket	下刀架 Lower Knife Holder	針 號 NEEDLE	
747L	514M-3-25/TG	E276	D210K D207	H204K	P226-A	LP226	KG242K-E	KJ246-E	KF203-E	KJ203-E	KD201J	KJ228K	KJ219	KR209	DCX27#11*2	
	514M-3-25/LFC-3	E276	D210K D207	H204K	P216-4	LP226	KG242K-E	KJ246-E	KF203-E	KJ203-E	KD201J	KJ208K	KJ219	KR209	DCX27#11*2	
	514H-3-28	E239	D210K D207	H204K	P201-8A	LP227A	KG242K-E	KJ248-E	KF203-E	KJ203-E	KD201JA	KJ228K	KJ238	KR209	DCX27#11*2	
	514H-3-28/ECA-U	E239U	D210K D207	H204K	P201-8A1	LP227A	KG242K-E	KJ248-E	KF203-E	KJ203-E	KD201JA	KJ228K	KJ238	KR209	DCX27#11*2	
	514M-3-23	E249	D210K D209	H204K	P220-A2	LP226	KG242K-E	KJ246-E	KF203-E	KJ203-E	KD201J	KJ208K	KJ219	KR209	DCX27#11*2	
	514M-3-23/ECB-U	E251U	D210K D207	H204K	P220-A2	LP226	KG242K-E	KJ246-E	KF203-E	KJ203-E	KD201J	KJ208K	KJ219	KR209	DCX27#11*2	
	514M-7-23/BK	E210	D203K D207	H203K	P202-A	LP226	KG242K-E	KJ246-E	KF203-E	KJ203-E	KD201J	KJ208K	KJ219	KR209	DCX27#11*2	
	514M-7-23/BK-1	E210	D203K D207	H203K	P202-A	LP226	KG242K-E	KJ246-E	KF203-E	KJ203-E	KD201J	KJ208K	KJ219	BK239	DCX27#11*2	
	514M-7-24/BK	E247	D203K D207	H203K	P202-A	LP226	KG242K-E	KJ246-E	KF203-E	KJ203-E	KD201J	KJ208K	KJ219	KR209	DCX27#11*2	
	514M-7-24/BK-1	E247	D203K D207	H203K	P202-A	LP226	KG242K-E	KJ246-E	KF203-E	KJ203-E	KD201J	KJ208K	KJ219	BK239	DCX27#11*2	
	514H-4-24	E226	D212 D207	H210	P220-A	LP230	KG242K-E	KJ248	KF203-E	KJ203-E	KD201JA	KJ228K	KJ238	KR209	DCX27#16*2	
	514H-7-24/BK	E247	D203K D207	H203K	P202-A	LP230	KG242K-E	KJ248	KF203-E	KJ203-E	KD201JA	KJ228K	KJ238	KR209	DCX27#16*2	
	514H-7-24/BK-1	E247	D203K D207	H203K	P202-A	LP230	KG242K-E	KJ248	KF203-E	KJ203-E	KD201JA	KJ228K	KJ238	BK239	DCX27#16*2	
	514H-4-24/TG	E226	D212 D207	H210	P226-A	LP230	KG242K-E	KJ248	KF203-E	KJ203-E	KD201JA	KJ228K	KJ238	KR209	DCX27#16*2	
	514H-4-25	E225	D212 D207	H210	P220-A	LP230	KG242K-E	KJ248	KF203-E	KJ203-E	KD201JA	KJ228K	KJ238	KR209	DCX27#16*2	
	514H-4-25/TG	E225	D212 D207	H210	P226-A	LP230	KG242K-E	KJ248	KF203-E	KJ203-E	KD201JA	KJ228K	KJ238	KR209	DCX27#16*2	
514H-4-25/ECA-U	E225U	D212 D207	H210	P201U-A1	LP230	KG242K-E	KJ248	KF203-E	KJ203-E	KD201JA	KJ228K	KJ238	KR209	DCX27#16*2		
514H-4-25/ECB-U	E225U	D212 D207	H210	P201U-A1	LP230	KG242K-E	KJ248	KF203-E	KJ203-E	KD201JA	KJ228K	KJ238	KR209	DCX27#16*2		
514H-7-25/BK	E248	D203K D207	H203K	P202-A	LP230	KG242K-E	KJ248	KF203-E	KJ203-E	KD201JA	KJ228K	KJ238	KR209	DCX27#16*2		
514H-7-25/BK-1	E248	D203K D207	H203K	P202-A	LP230	KG242K-E	KJ248	KF203-E	KJ203-E	KD201JA	KJ228K	KJ238	BK239	DCX27#16*2		
757L	401M-6/TW	E237	D219K	H219K	P506-A		KG253K-E	KJ247-E	KF203-E	KJ206-E	KD201J	TW201			DCX27#14*1	
	516M-8-35/GA	E213	D204K D207	H205K	P508J-A	LP226	KG253K-E	KJ247-E	KF203-E	KJ206-E	KD201J	KJ236K	KJ219	KR219	DCX27#14*2	
	516M-8-35/GA/P	E213	D204K D207	H205K	P508JP-A	LP226	KG253K-E	KJ247-E	KF203-E	KJ206-E	KD201J	KJ236K	KJ219	KR219	DCX27#14*2	
	516M-8-55/GA	E214	D205K D207	H206K	P509J-A	LP226	KG255K-E	KJ247-E	KF203-E	KJ206-E	KD201J	KJ236K	KJ219	KR219	DCX27#14*2	
	516M-8-55/GA/P	E214	D205K D207	H206K	P509JP-A	LP226	KG255K-E	KJ247-E	KF203-E	KJ206-E	KD201J	KJ236K	KJ219	KR219	DCX27#14*2	
	516L-2-24	E215	D206 D207	H207	P500J-A	LP225	KG252K-E	KJ247-E	KF203-E	KJ206-E	KD201J	KJ236K	KJ219	KR219	DCX27#14*2	
	516L-2-35	E216	D206 D207	H212	P504K-A	LP225	KG253K-E	KJ247-E	KF203-E	KJ206-E	KD201J	KJ236K	KJ219	KR219	DCX27#14*2	
516M-3-35	E269	D208K D207	H208K	P504K-A	LP226	KG253K-E	KJ247-E	KF203-E	KJ206-E	KD201J	KJ236K	KJ219	KR219	DCX27#11*2		

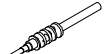
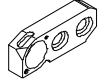
SIRUBA GAGE PARTS LIST		Series						Remark						Page	Date	
		700L												3 / 3	2020/07/22	
																
機 型 MODEL		針板 NEEDLE PLATE	送 具 FEED DOG		送 具 FEED DOG	押 具 PRESSER FOOT	勾 針 LOOPER	針 留 NEEDLE CLAMP	束 子 COLLER	衝 程 CRANK	衝 程 CRANK	大 心 Crankshaft	勾針連桿座 Upper Looper Holder	過線器 Bracket	下刀架 Lower Knife Holder	針 號 NEEDLE
757L	516M-3-35/PS	E227	D208K	D207	H214K	P504JS-A	LP226	KG253K-E	KJ247-E	KF203-E	KJ206-E	KD201J	KJ236K	KJ219	KR219	DCX27#14*2
	516M-3-35/ECA-U	E217U	D208K	D207	H214K	P504J-A	LP226	KG253K-E	KJ247-E	KF203-E	KJ206-E	KD201J	KJ236K	KJ219	KR219	DCX27#11*2
	516M-3-35/ECB-U	E217U	D208K	D207	H214K	P504J-A	LP226	KG253K-E	KJ247-E	KF203-E	KJ206-E	KD201J	KJ236K	KJ219	KR219	DCX27#11*2
	516M-3-35/CTE	E217U	D208K	D207	H214K	P504J-A	LP226	KG253K-E	KJ247-E	KF203-E	KJ206-E	KD201J	KJ236K	KJ219	KR219	DCX27#11*2
	516M-3-55	E254	D208K	D207	H209K	P502K-A	LP226	KG255K-E	KJ247-E	KF203-E	KJ206-E	KD201J	KJ236K	KJ219	KR219	DCX27#14*2
	516M-3-55/PS	E228	D208K	D207	H215K	P502JS-A	LP226	KG255K-E	KJ247-E	KF203-E	KJ206-E	KD201J	KJ236K	KJ219	KR219	DCX27#14*2
	516M-3-55/ECA-U	E218U	D208K	D207	H209K	P502J-A	LP226	KG255K-E	KJ247-E	KF203-E	KJ206-E	KD201J	KJ236K	KJ219	KR219	DCX27#11*2
	516M-3-55/ECB-U	E218U	D208K	D207	H209K	P502J-A	LP226	KG255K-E	KJ247-E	KF203-E	KJ206-E	KD201J	KJ236K	KJ219	KR219	DCX27#11*2
	516M-3-55/CTE	E218U	D208K	D207	H209K	P502J-A	LP226	KG255K-E	KJ247-E	KF203-E	KJ206-E	KD201J	KJ236K	KJ219	KR219	DCX27#11*2
	516H-3-55	E259	D602	D601	H220A	P964-A	LP233	KG255K-E	KJ246-E	KF215-E	KJ203-E	KD201JA	KJ208K	KJ233	KR223	DCX27#21*2
	516H-3-55/ECA-U	E218U	D602	D601	H220A	P964-A	LP233	KG255K-E	KJ246-E	KF215-E	KJ203-E	KD201JA	KJ208K	KJ233	KR223	DCX27#21*2
	516H-3-56	E260	D602	D601	H220A	P964-A	LP233	KG255K-E	KJ246-E	KF215-E	KJ203-E	KD201JA	KJ208K	KJ233	KR223	DCX27#21*2
	516X-3-55	E259	D602	D601	H220A	P964-A	LP233	KG601-E	KJ246-E+KJ234	KF203-E	KJ602-E	KD601	KJ601	KJ233	KR223	DCX27#21*2
	516X-3-56	E260	D602	D601	H220A	P964-A	LP233	KG601-E	KJ246-E+KJ234	KF203-E	KJ602-E	KD601	KJ601	KJ233	KR223	DCX27#21*2
	516X-3-56/ECA-U	E234U	D602	D601	H220A	P964-A	LP233	KG601-E	KJ246-E+KJ234	KF203-E	KJ602-E	KD601	KJ601	KJ233	KR223	DCX27#21*2
	516X-3-56/ECB-U	E234U	D602	D601	H220A	P964-A	LP233	KG601-E	KJ246-E+KJ234	KF203-E	KJ602-E	KD601	KJ601	KJ233	KR223	DCX27#21*2
	516X-3-56/CTE	E234U	D602	D601	H220A	P964-A	LP233	KG601-E	KJ246-E+KJ234	KF203-E	KJ602-E	KD601	KJ601	KJ233	KR223	DCX27#21*2
401M-8-30/TA	E235	D211K	D222K	H216K	P224-A		KG266-E	KJ247-E	KF203-E	KJ206-E	KD201J	TW201		KR219	DCX27#14*2	
401M-8-50/TA	E238	D211K	D222K	H216K	P223-A		KG256K-E	KJ247-E	KF203-E	KJ206-E	KD201J	TW201		KR219	DCX27#14*2	
767L	644M-3-324	E272	D208K	D207	H209K	P233K-A	LP226	KG433K-E	KJ246-E	KF203-E	KJ203-E	KD201J	KJ208K	KJ219	KR219	DCX27#11*3
	644M-3-324/PS	E270	D208K	D207	H226	P233S-A	LP226	KG433K-E	KJ246-E	KF203-E	KJ203-E	KD201J	KJ208K	KJ219	KR219	DCX27#14*3
	644M-3-324/ECA-U	E219U	D208K	D207	H209K	P233J-A	LP226	KG433K-E	KJ246-E	KF203-E	KJ203-E	KD201J	KJ208K	KJ219	KR219	DCX27#11*3
	644M-3-324/ECB-U	E219U	D208K	D207	H209K	P233J-A	LP226	KG433K-E	KJ246-E	KF203-E	KJ203-E	KD201J	KJ208K	KJ219	KR219	DCX27#11*3
	644M-3-524	E273	D208K	D207	H209K	P255K-A	LP226	KG455K-E	KJ246-E	KF203-E	KJ203-E	KD201J	KJ228K	KJ219	KR219	DCX27#11*3
	644M-3-524/PS	E271	D208K	D207	H226	P255S-A	LP226	KG455K-E	KJ246-E	KF203-E	KJ203-E	KD201J	KJ228K	KJ219	KR219	DCX27#14*3
	644M-3-524/ECB-U	E224U	D208K	D207	H209K	P255J-A	LP226	KG455K-E	KJ246-E	KF203-E	KJ203-E	KD201J	KJ228K	KJ219	KR219	DCX27#11*3

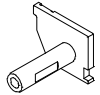
SIRUBA PARTS LIST	Series	Parts Group	Subclass / Remark	Page
	700L	KA		1/1
				Date
				2021/04/07

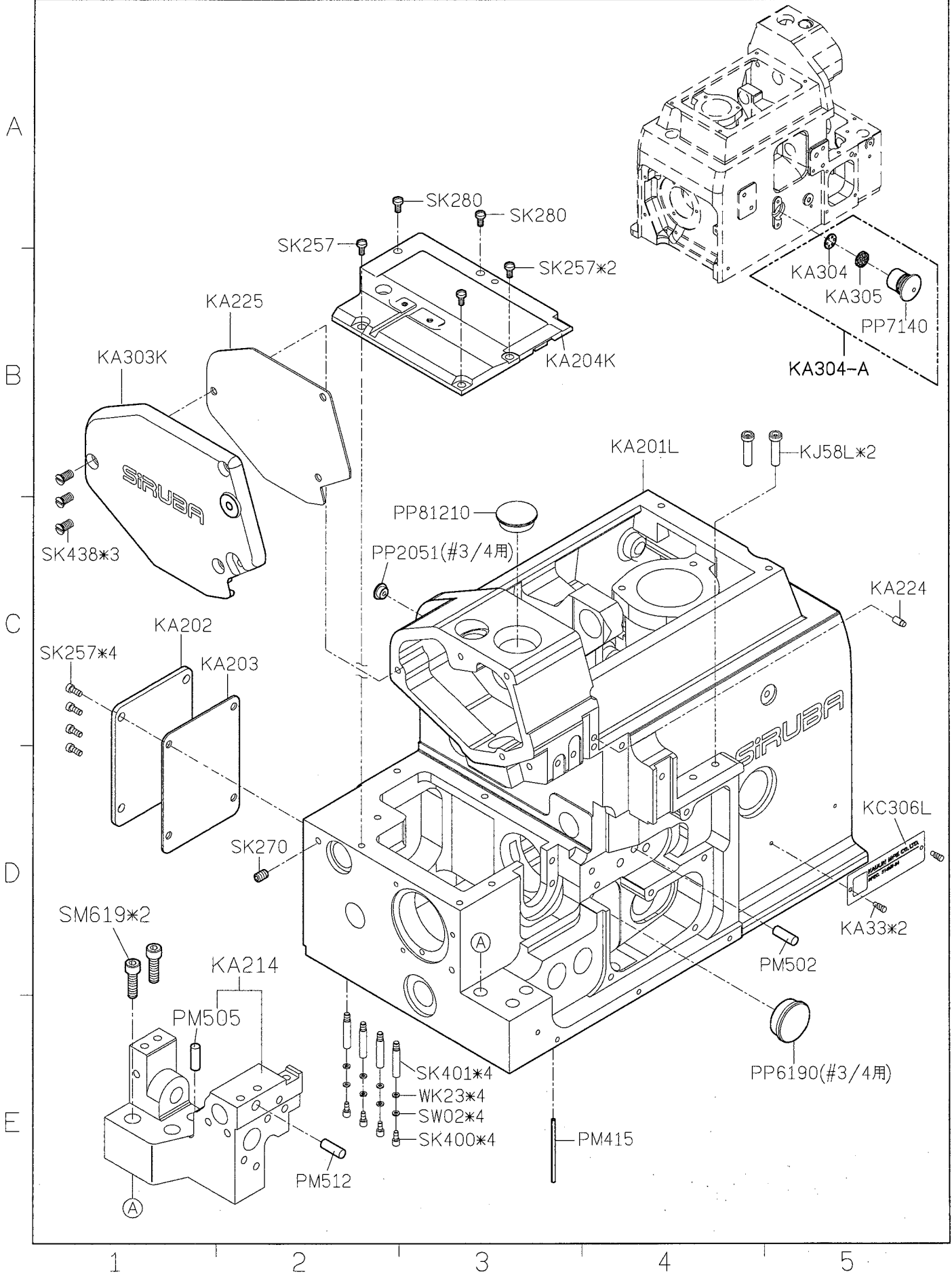

SIRUBA PARTS LIST	Series	Parts Group	Subclass / Remark	Page
	700L	KB		1/1
				Date
				2017/05/23

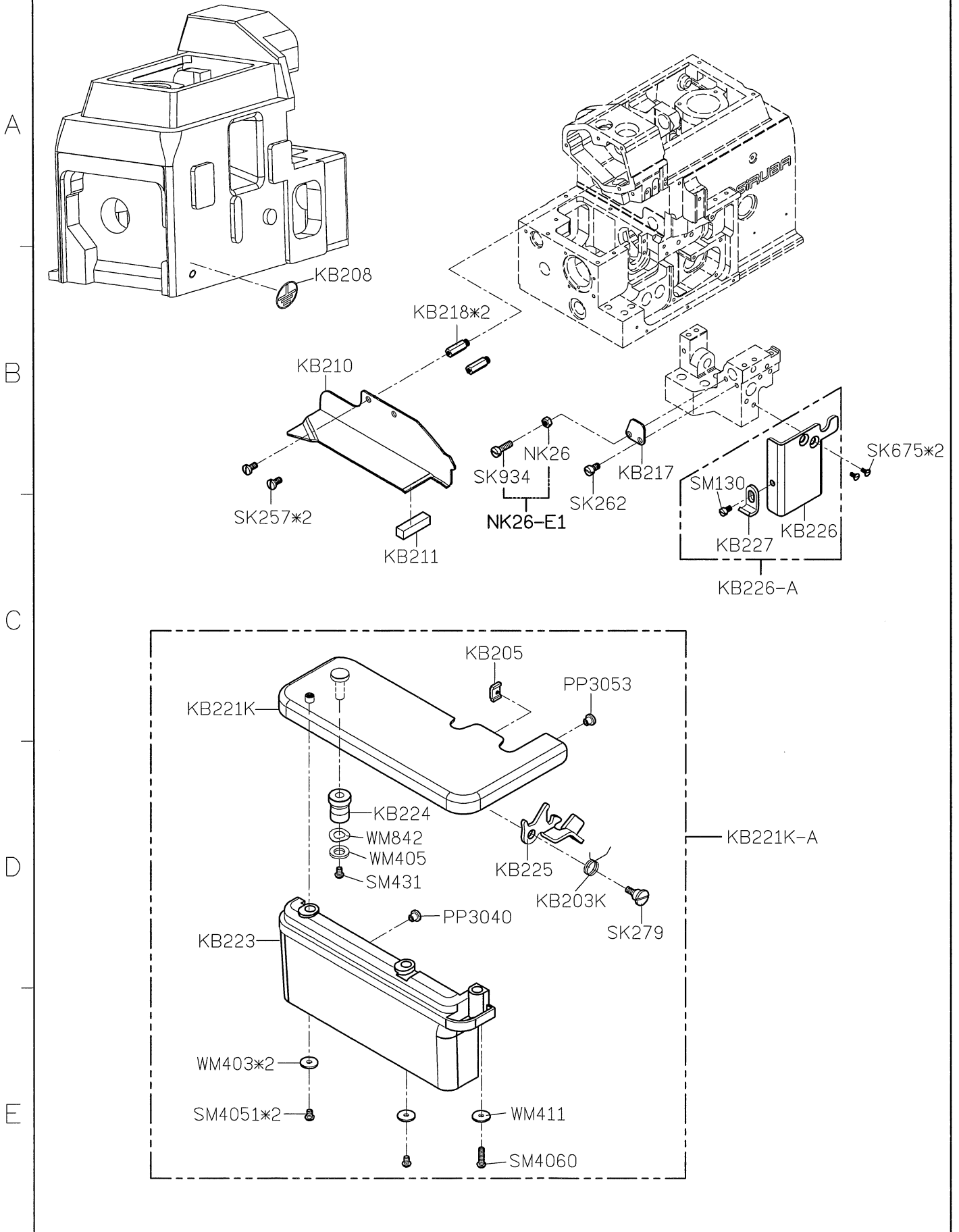

SIRUBA PARTS LIST	Series	Parts Group	Subclass / Remark	Page
	700L	KC		1/1
				Date
				2020/07/13

	700L
#3	KC38L-3
#4	KC38L-4
#5	KC38L-5
#6	KC38L-6

MODEL	#3/#4	#5/#6
PARTS NO	KC209K	KC219K
	KC303K-4	KC303K-5

A
B
C
D
E

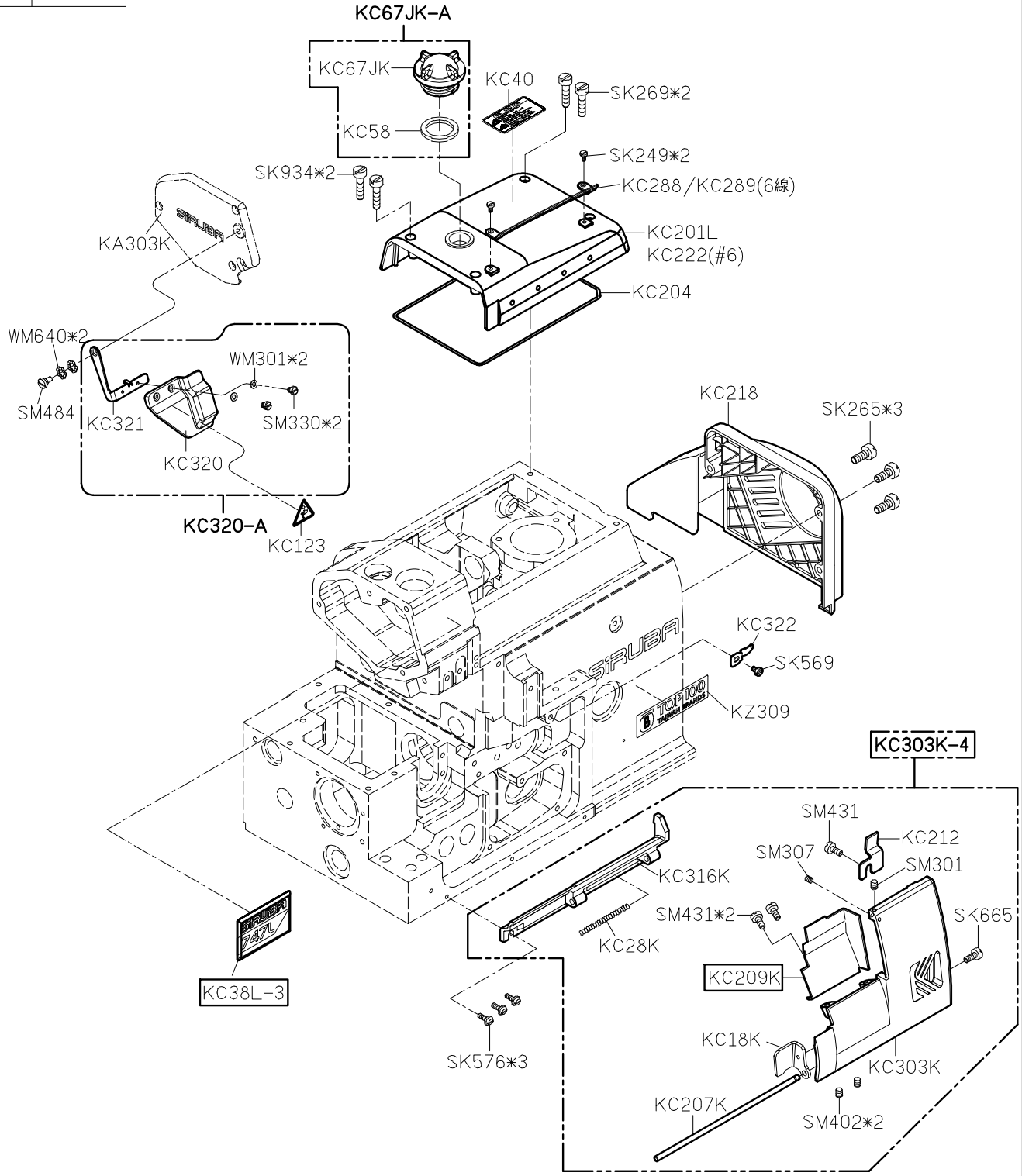

1 2 3 4 5

SIRUBA

PARTS LIST

Series

700L

Parts Group

KD

Subclass / Remark

Page

1/1

Date

2017/11/22

MODEL	#3/#4	#5/#6	H-3/-4/-7	X-3
PARTS NO	KD204	KD217	KD204	KD217
	SM603B	KD220	SM603B	KD220
	SK241*3	SK539*2 SK872*1	SK241*3	SK539*2 SK872*1
	KD201J	KD201JA	KD601	

A

B

C

D

E

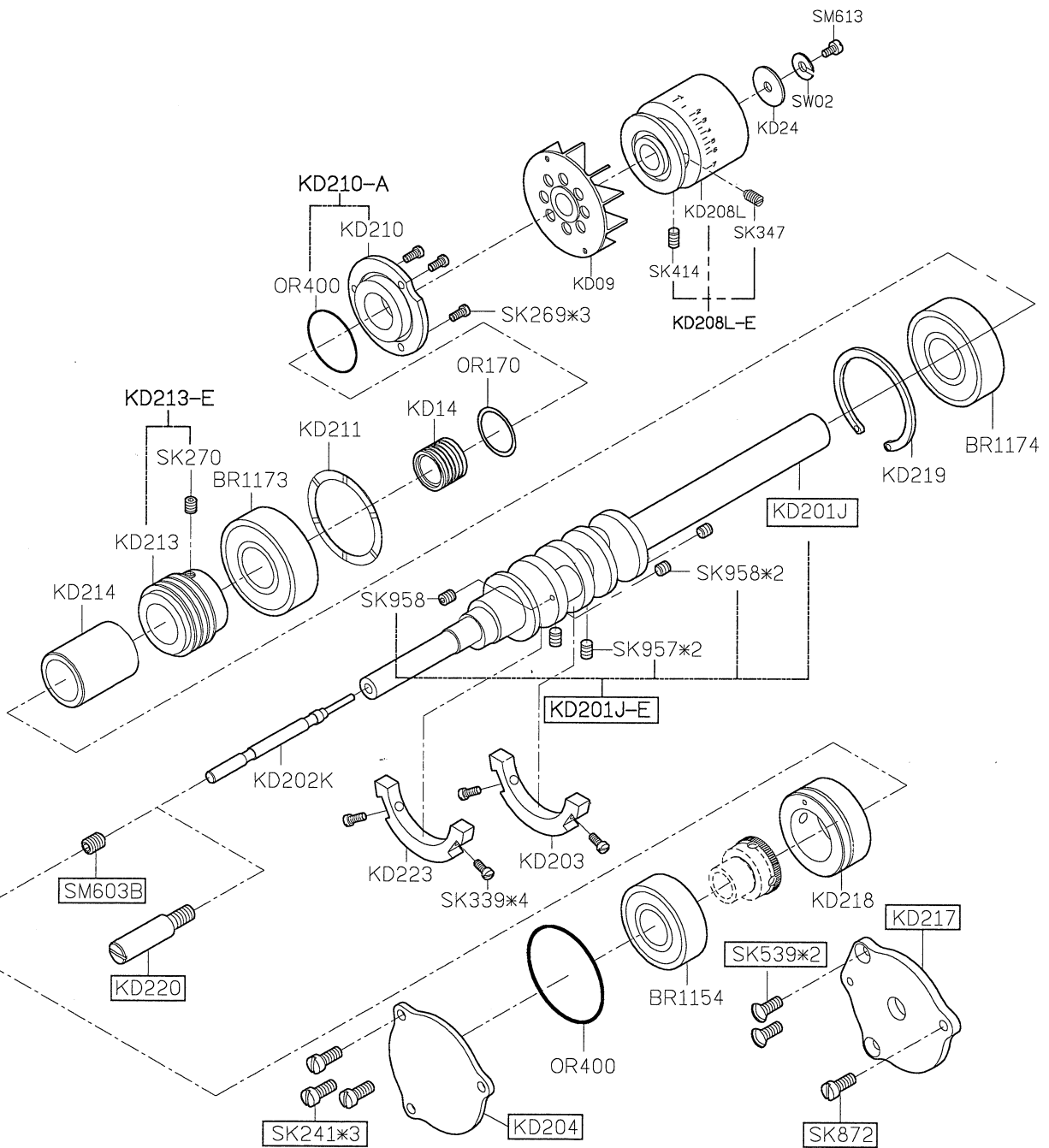

1

2

3

4

5

SIRUBA PARTS LIST	Series	Parts Group	Subclass / Remark	Page
	700L	KF		1/3
				Date
				2020/03/25

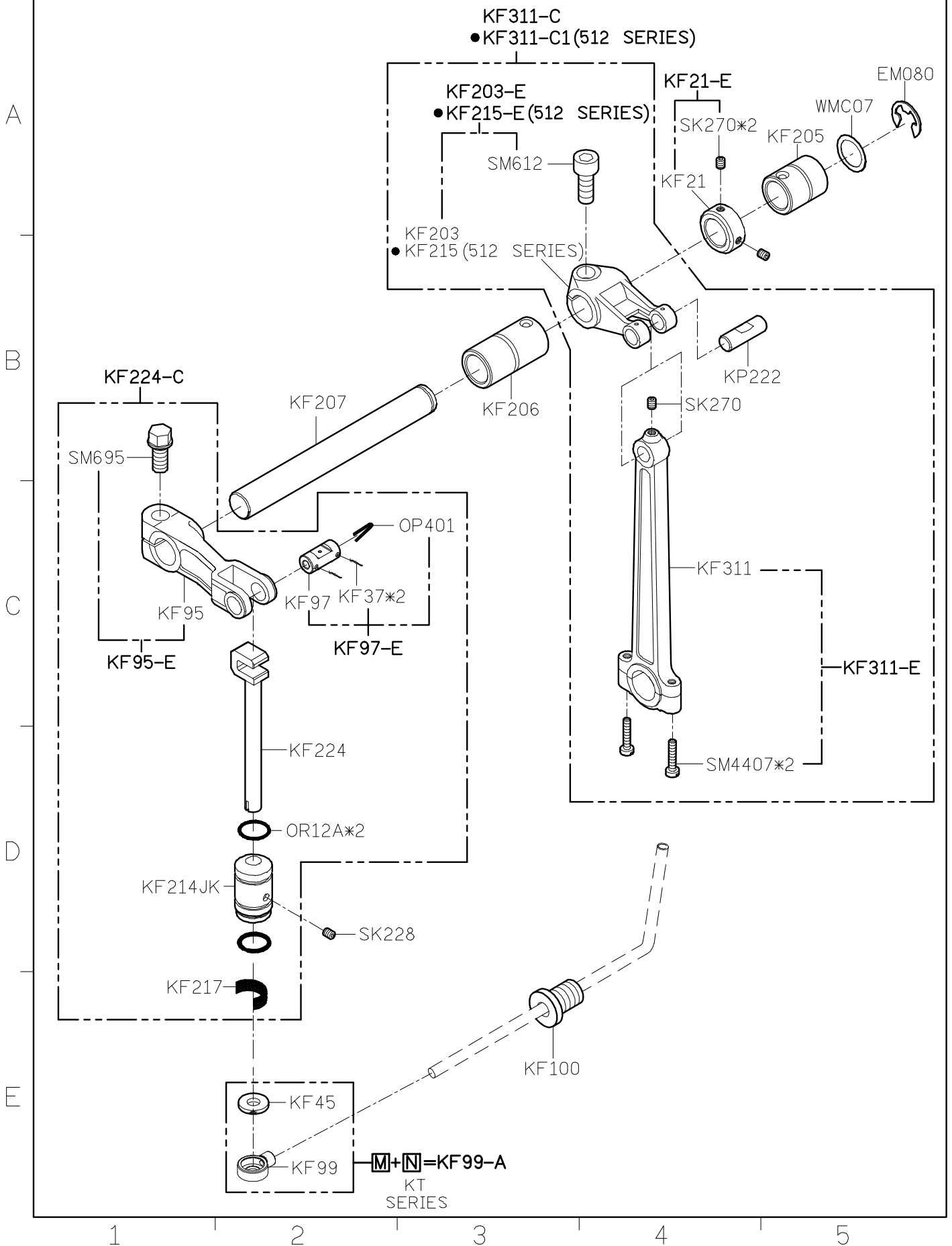

SIRUBA PARTS LIST	Series	Parts Group	Subclass / Remark	Page
	700L	KF	FOR H-3	2/3
				Date
				2020/03/25

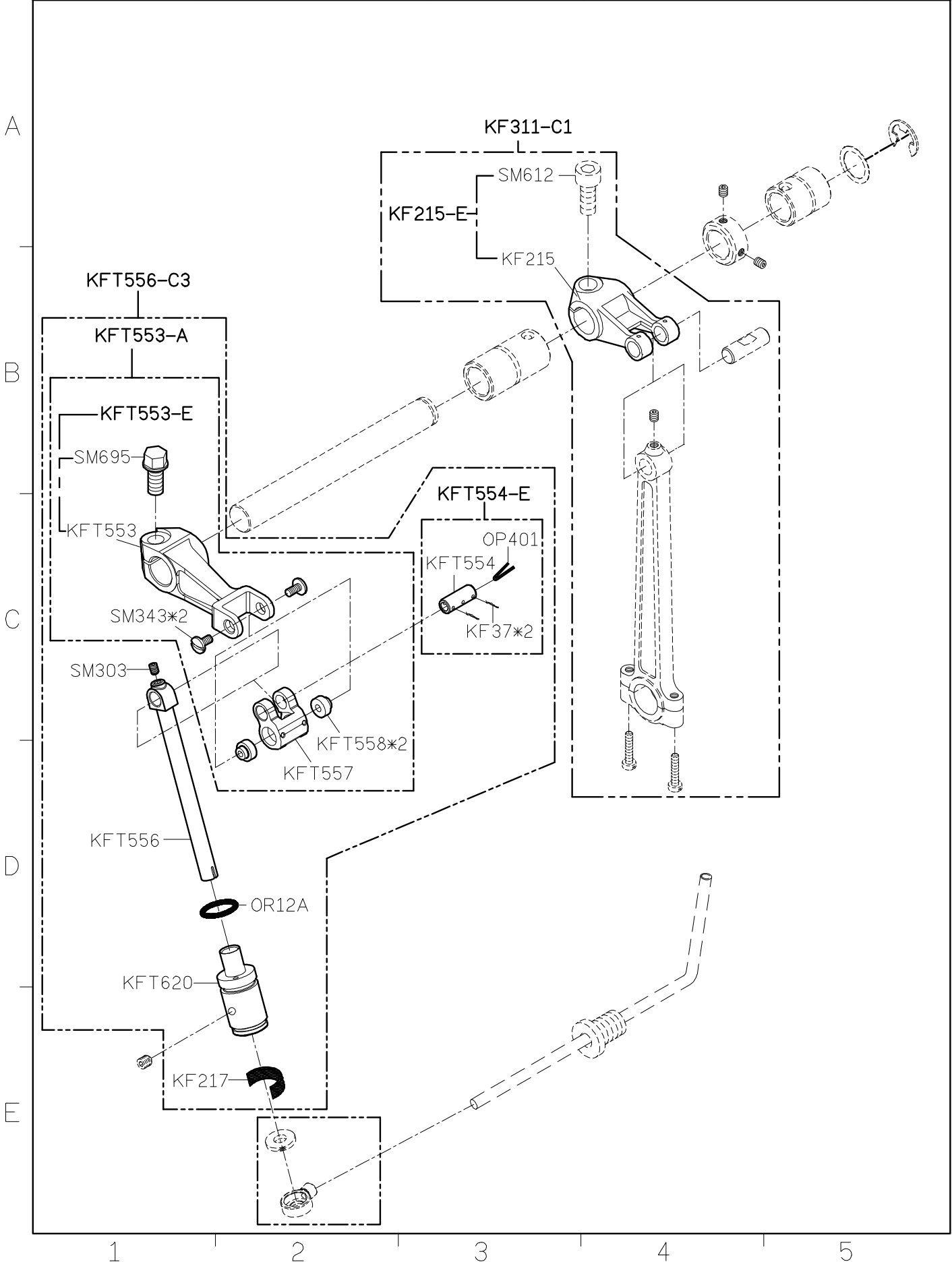

SIRUBA PARTS LIST	Series	Parts Group	Subclass / Remark	Page
	700L	KF	FOR X-3	3/3
				Date
				2020/03/25

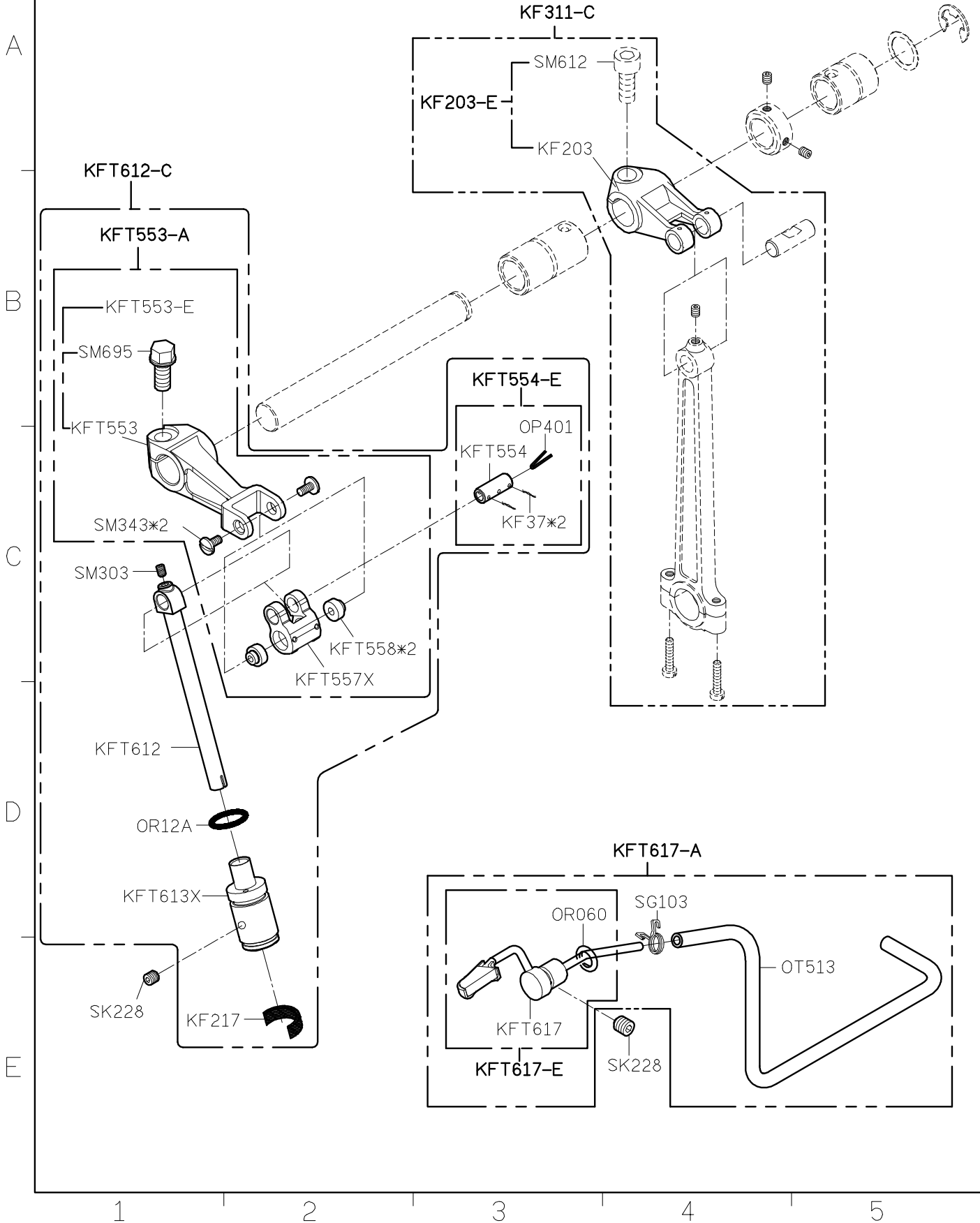

SIRUBA

PARTS LIST

Series

700L

Parts Group

KG

Subclass / Remark

Page

1/1

Date

2018/10/29

MODEL	#3	#4	#5	#5-X-3	#6	FOR(#3/#4)	FOR(#5/#6)
	KG262	KG211K	KG262	KG604L	KG211K		SK569
	KG248	KG213K	KG239	KG239	KG246	KG212-3	SK437N
	KG250K	KG269	KG243K	KG605	KG251K	KG211K	
	KG222	KG222	KG245	KG245	KG245	SK250N	
	KG225	KG225	KG261	KG261	KG261	KG212	SK216
	KG201	KG201	KG244	KG244	KG244	KG248	
	KG93	KG92	KG267	KG603	KG267	SK216	KG238
	SK216	SK216	SK216*2	SK216*2	SK216*2	SK250N	SK216
	SK250N	SK250N	SK250N*2	SK250N*2	SK250N*2	SK250N	SK250N
	SK437N	SK437N	SK569	SK569	SK569	SK674N	SK674N
	SM251	SM251	SM250	SM250	SM250		KG241-5
	KG212-3	KG212-4	KG241-5	KG606-5	KG241-6		
	KG223-4	KG223-4	KG223-5	KG223-5	KG223-5		
			KG238	KG606	KG238		
			KG41	KG608	KG41		
			KG41-E	KG608-E	KG41-E		
			KG234	KG234K	KG234		

A PARTS NO

B

C

D

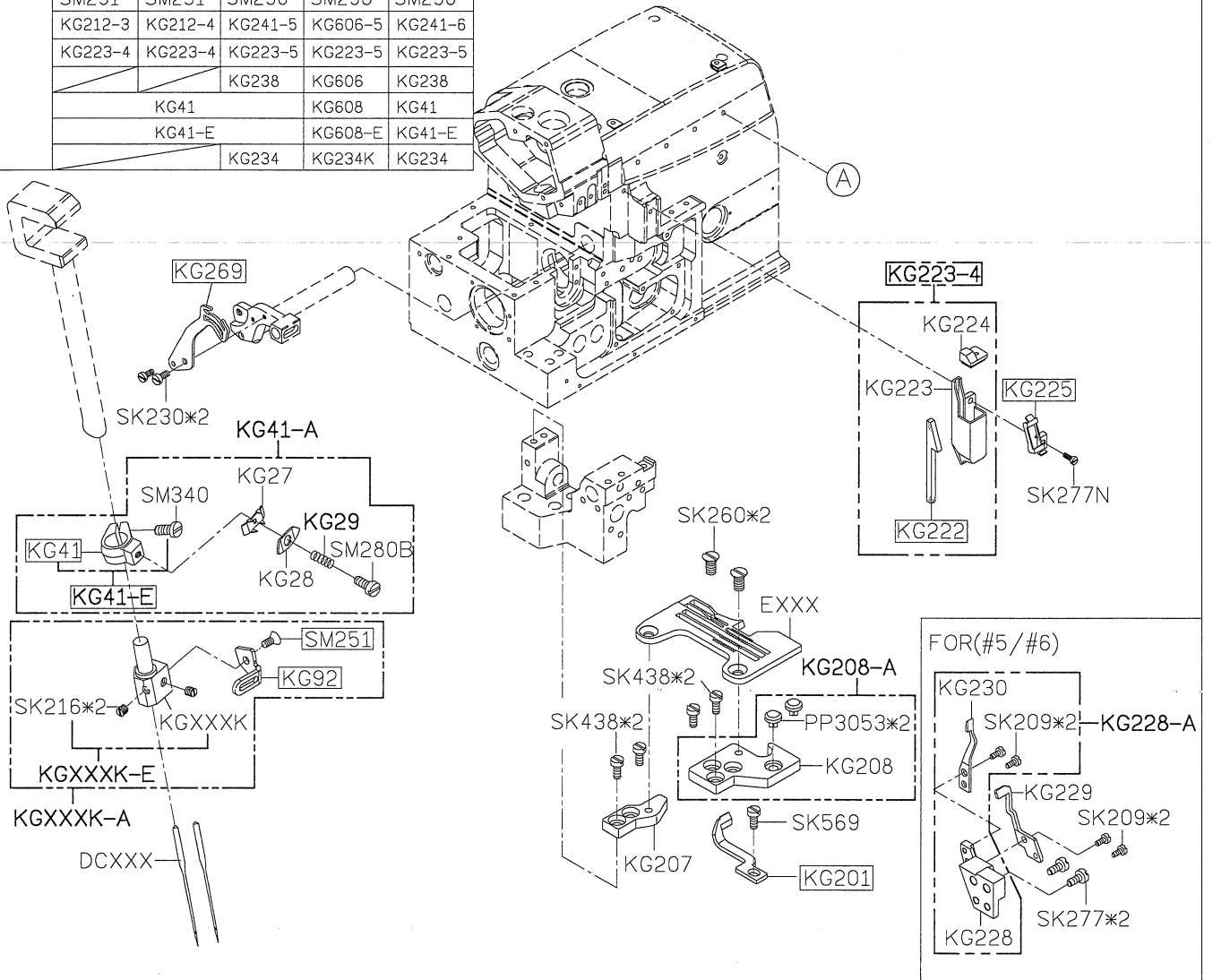

FOR(#3)

FOR(#4/#5)

H-3/H-4/X-3

FOR(#6)

E

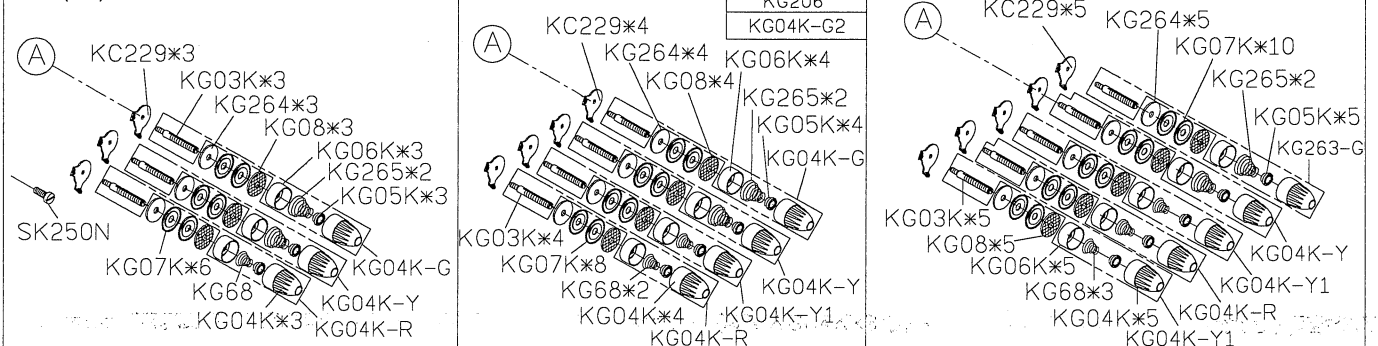

1

2

3

4

5

SIRUBA

PARTS LIST

Series

700L

Parts Group

KJ

Subclass / Remark

Page

1/2

Date

2018/11/19

MODEL	#3/#5	#4/#6	#4 H-3/H-4/H-7	#5 H-3	#5 X-3
	KJ247-E	KJ246-E	KJ248-E	KJ246-E	KJ246-E+KJ234
	KJ206	KJ203	KJ203	KJ203	KJ602
	KJ206-E	KJ203-E	KJ203-E	KJ203-E	KJ602-E
	KJ206-C1	KJ203-C1	KJ203-C1	KJ203-C1	KJ602-C
	KJ236K	KJ208K	KJ228K	KJ208K	KJ601
	KJ236K-C1	KJ208K-C1	KJ228K-C1	KJ208K-C1	KJ601-C
	KJ219		KJ238	KJ233	KJ233
	KJ210L		KJ210L	KJ210L	KJ603
	KJ210L-A		KJ210L-A	KJ210L-A	KJ603-A
	KJ209		KJ209	KJ209	KJ609

A

B

C

D

E

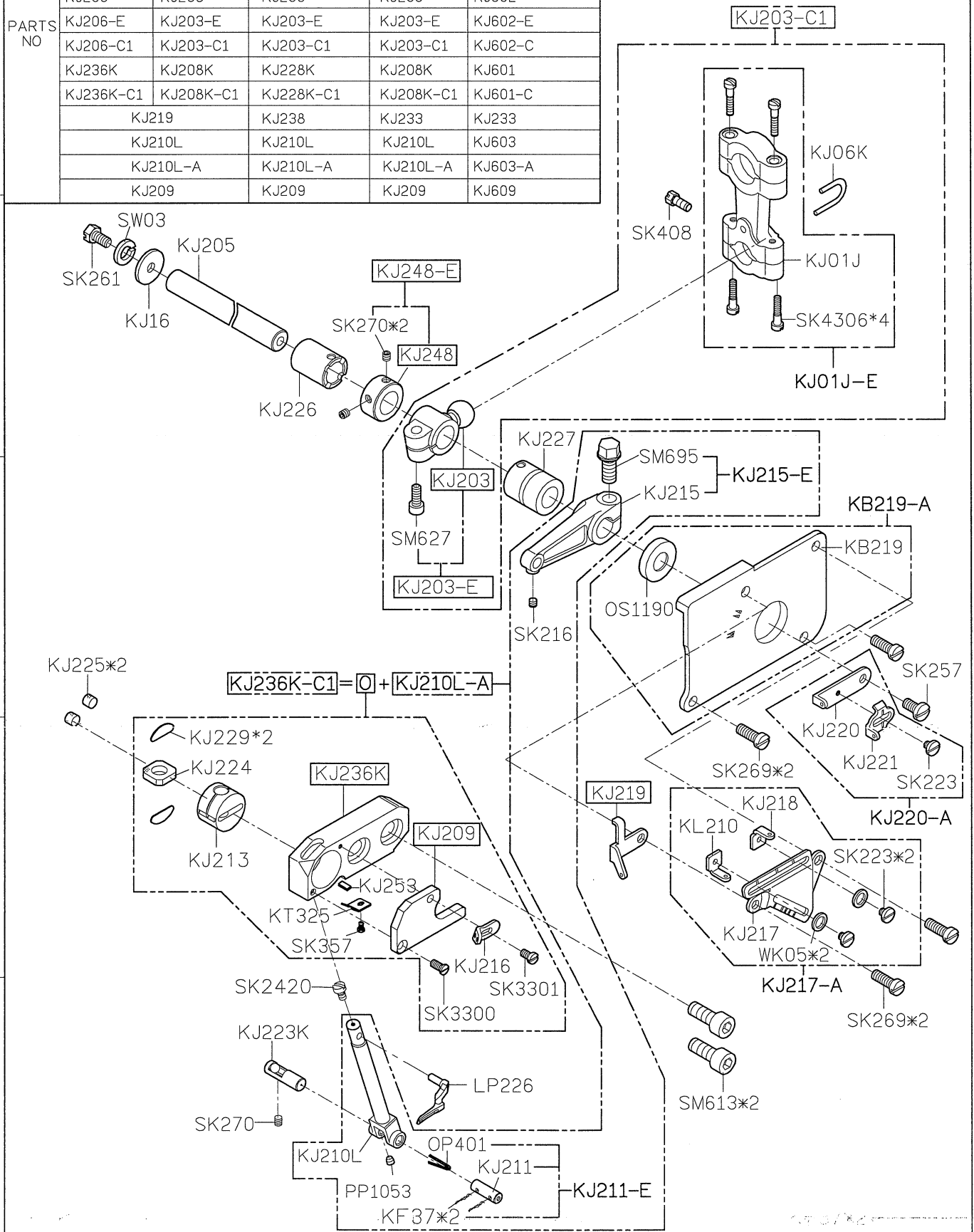

1

2

3

4

5

A

B

C

D

E

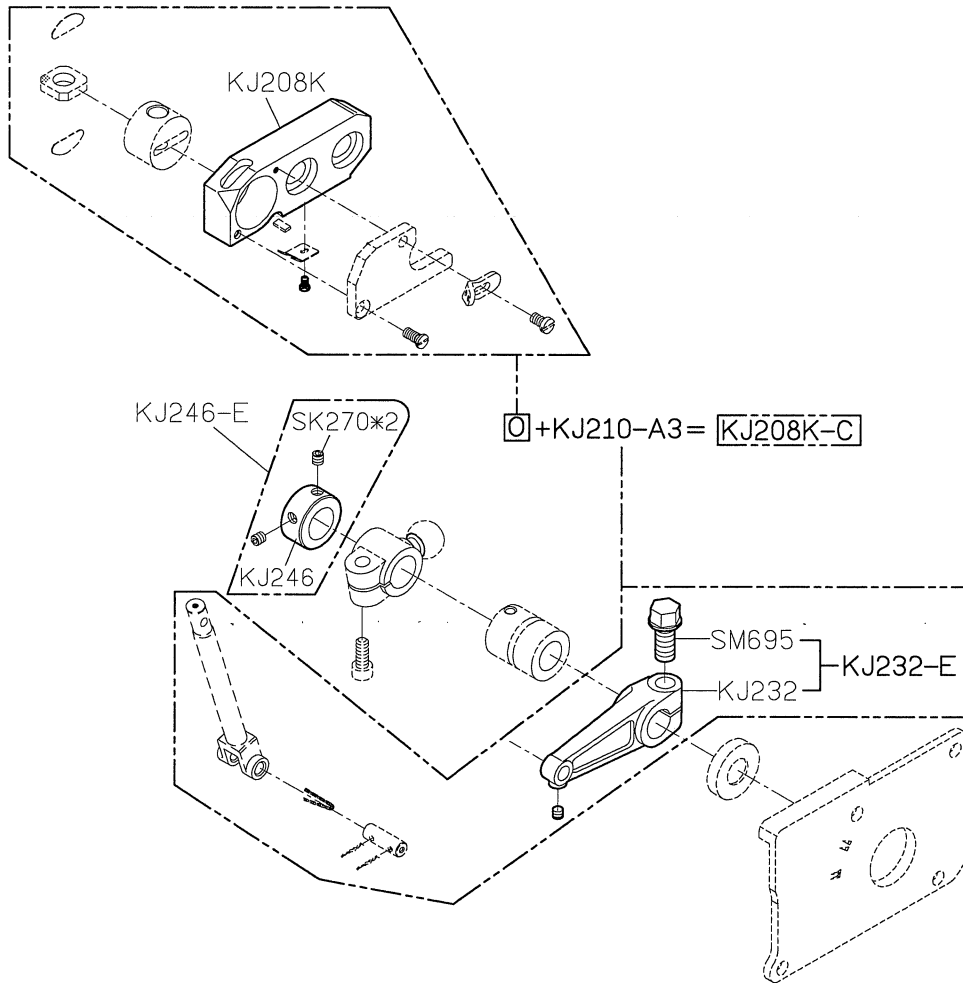

SIRUBA PARTS LIST	Series	Parts Group	Subclass / Remark	Page
	700L	KL		1/1
				Date
				2017/11/22

MODEL	#3/#4	#5/#6	H-3/H-4/H-7 SERIES	5# H-3 SERIES	5# X-3 SERIES
PARTS NO	KJ222		KJ222	KJ230	KFT597
	KL202		KL202A	KL202	KL202
	KL211-A		KL211-A1	KL211-A2	KFT597-A
	KL205	KL209			
		SK270			
	KL205-E	KL209-E			
	KL205-C	KL209-C			

A

B

C

D

E

KL KL KM
 SERIES SERIES SERIES
 $P + R + S = KL209-C$
 KL KL
 SERIES SERIES
 $P + Q = KL205-C$

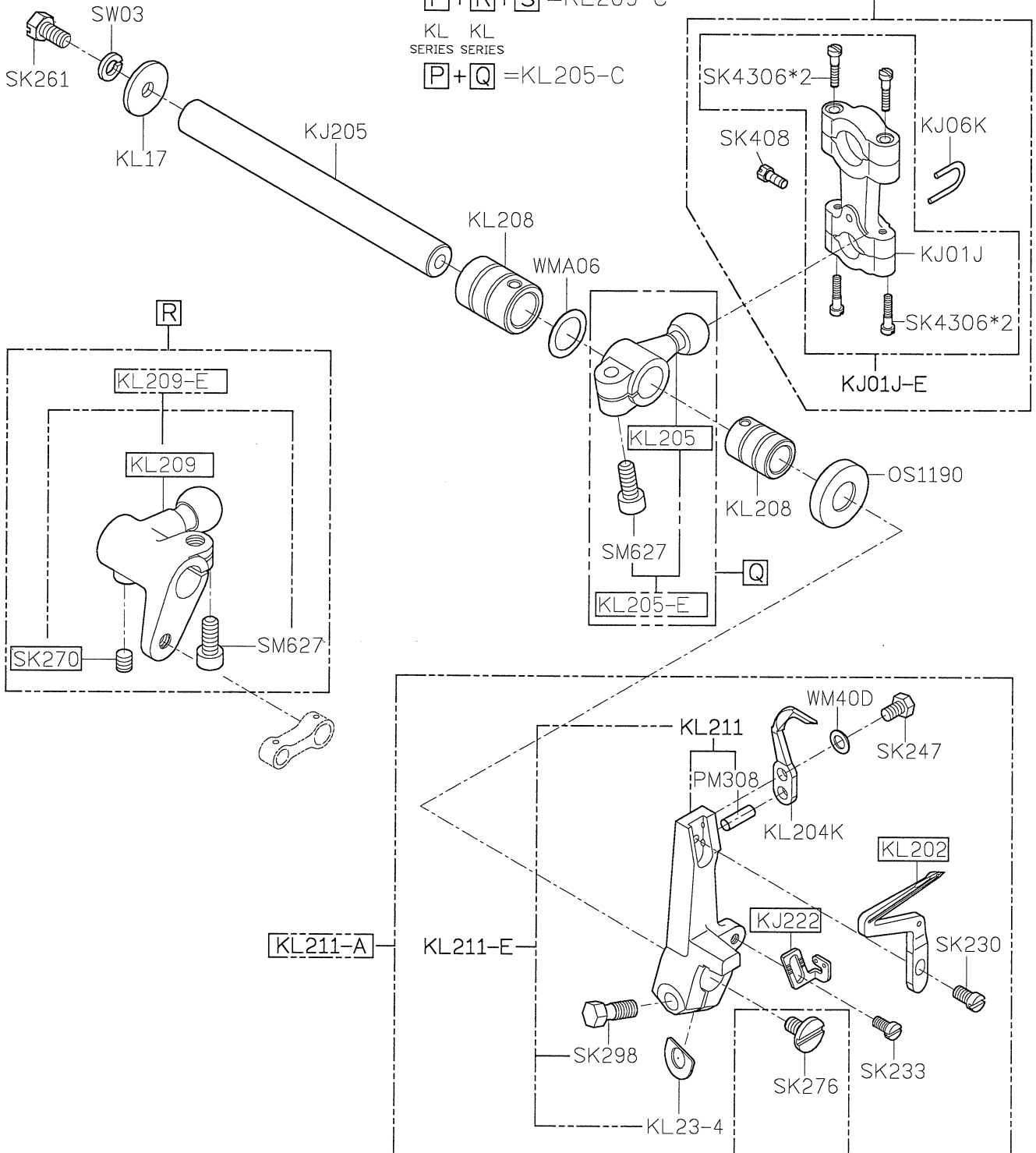

1

2

3

4

5

SiRUBA PARTS LIST	Series	Parts Group	Subclass / Remark	Page
	700L	KM		1/1
				Date
				2019/08/06

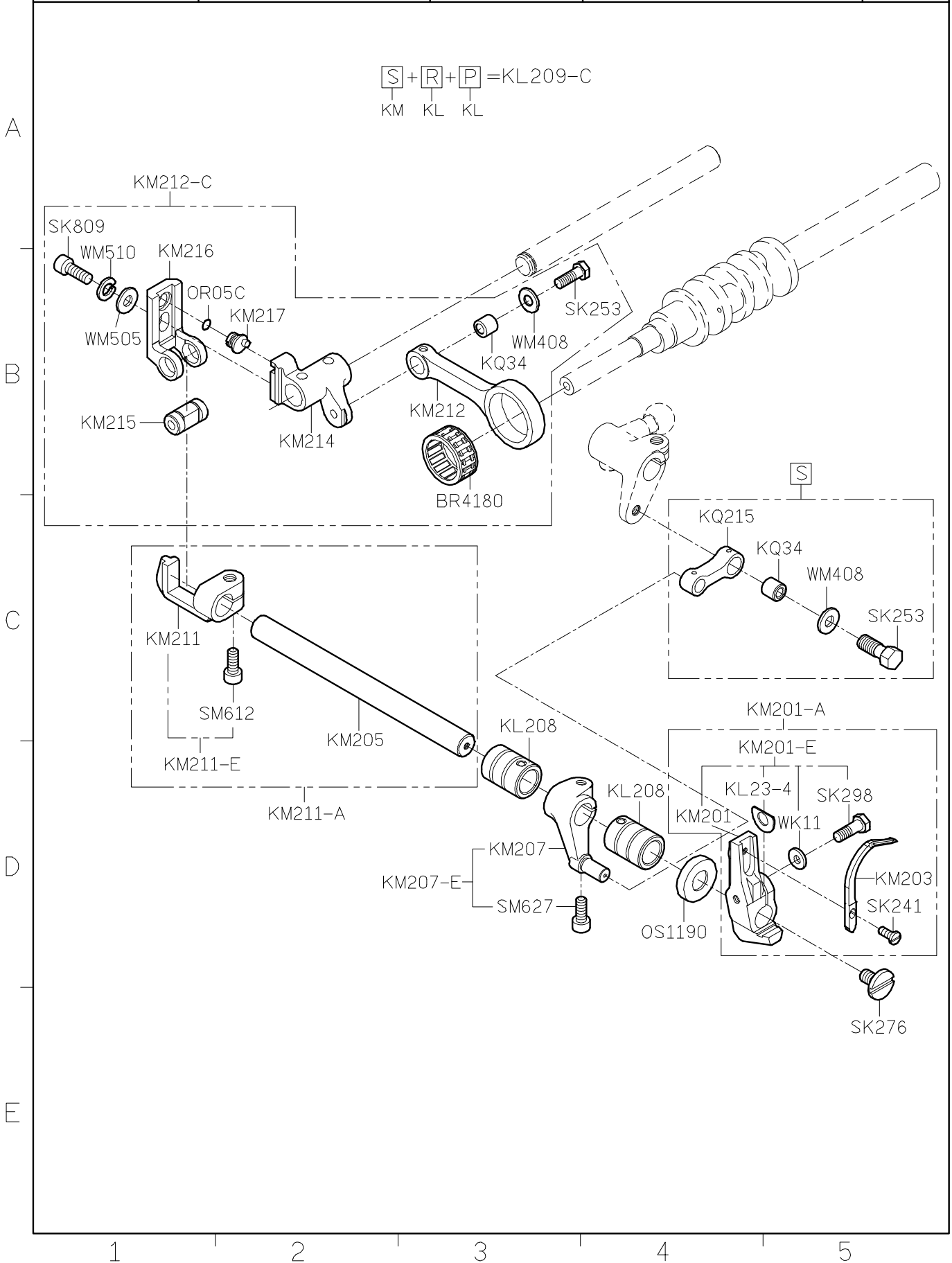

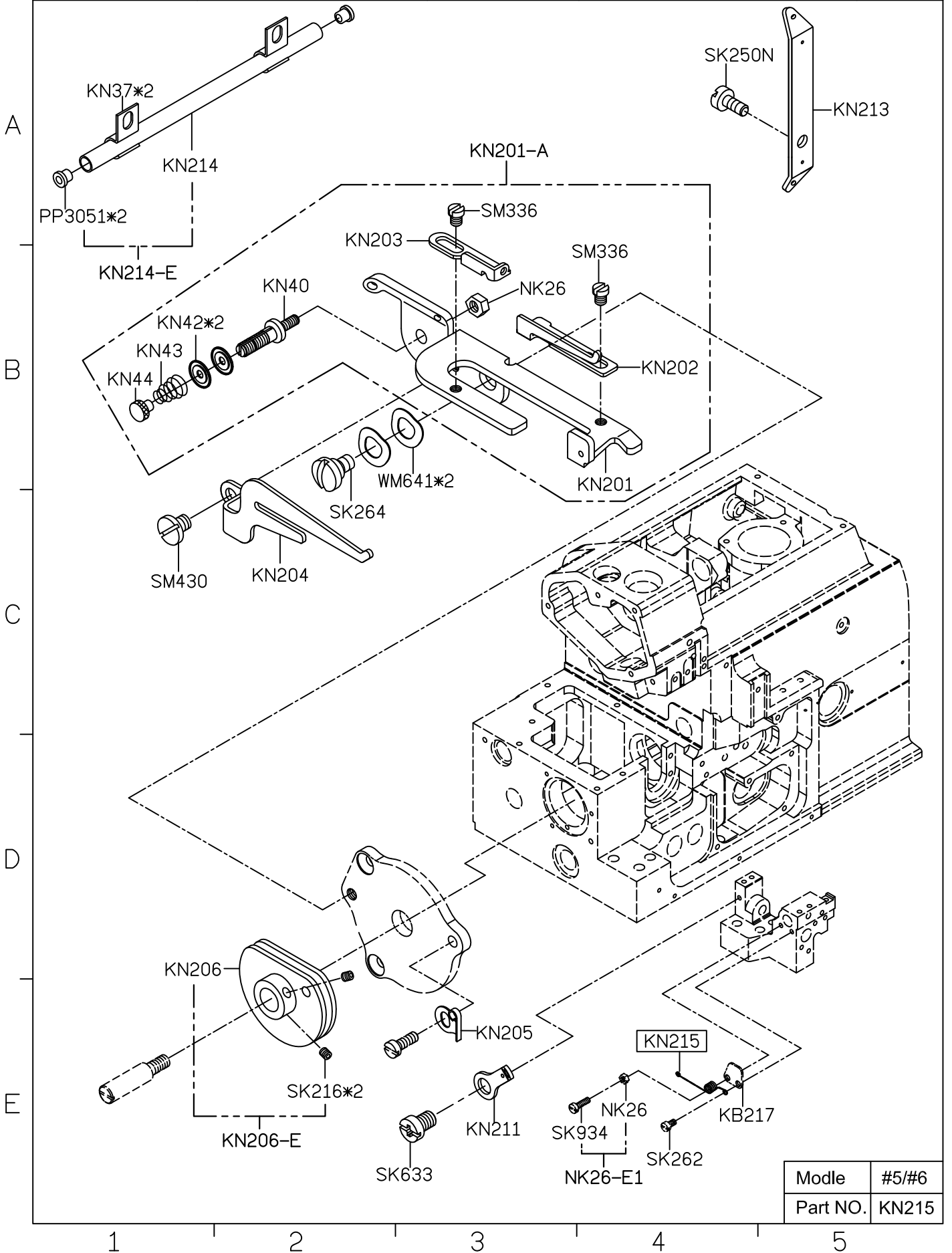

Modle	#5/#6
Part NO.	KN215

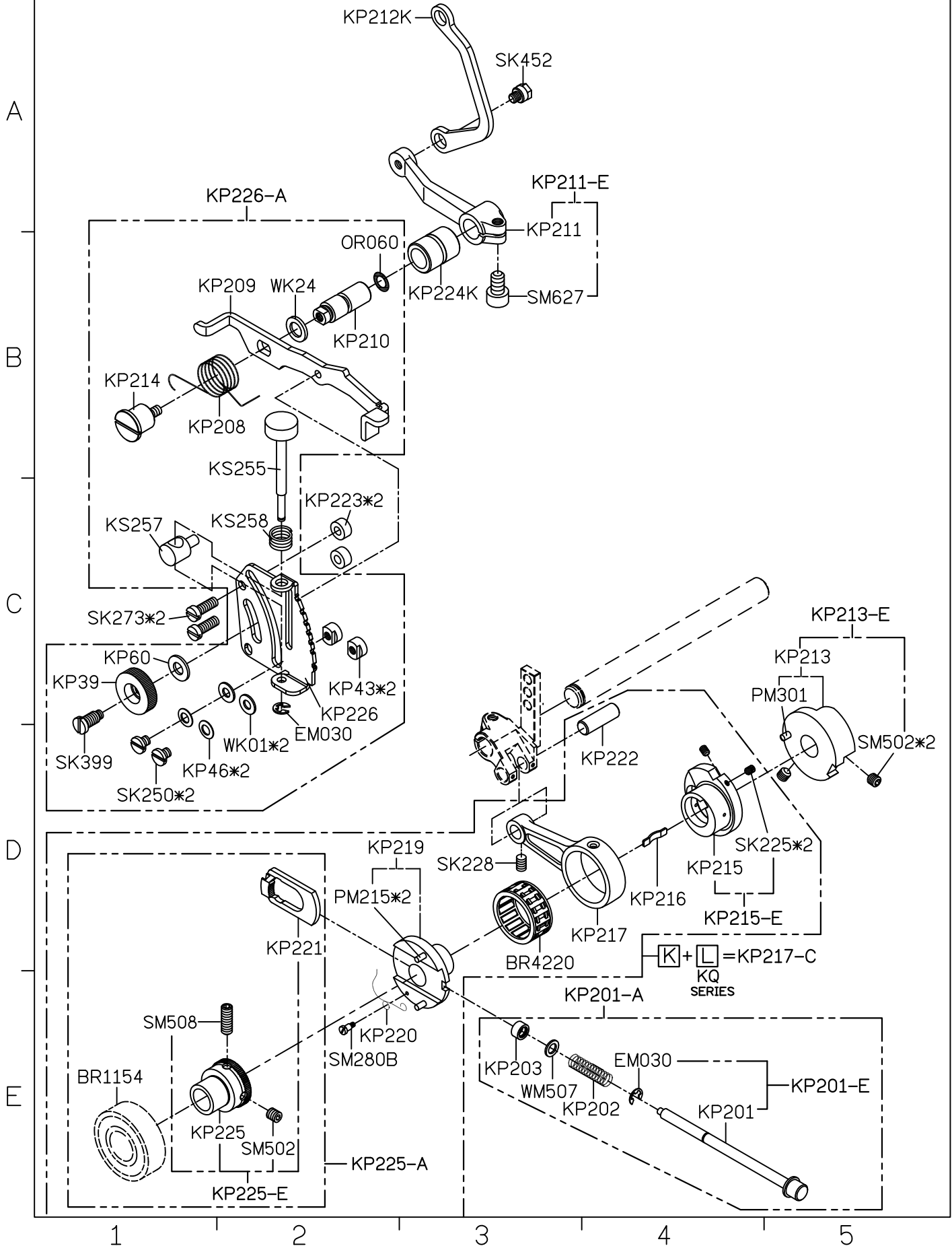

A

B

C

D

E

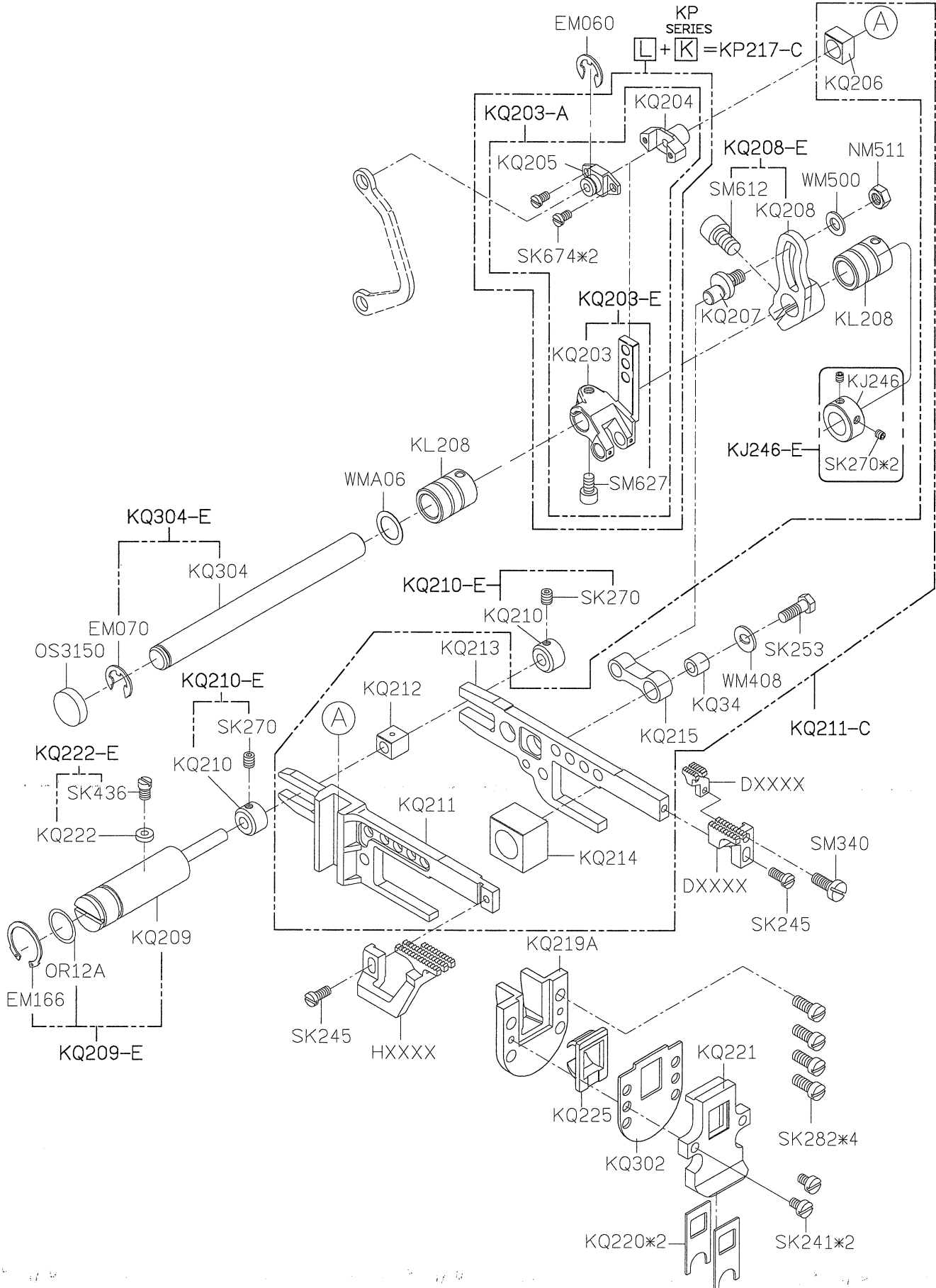

SIRUBA PARTS LIST	Series	Parts Group	Subclass / Remark	Page
	700L	KR		1/1
				Date
				2017/11/22

MODEL	#3/#4	#5/#6	#5 X-3
PARTS NO	KR202	KR218	KR218
	KR202-E	KR218-E	KR218-E
	KR311-C	KR311-C1	KR311-C1
	KR206K	KR221	KFT616
	KR206K-A	KR221-A	KFT596-A
	KR209	KR219	KR223
	KR209-A	KR219-A	KR223-A1
	KR35	KR35	KR35JK
		KR212	KFT614

A

B

C

D

E

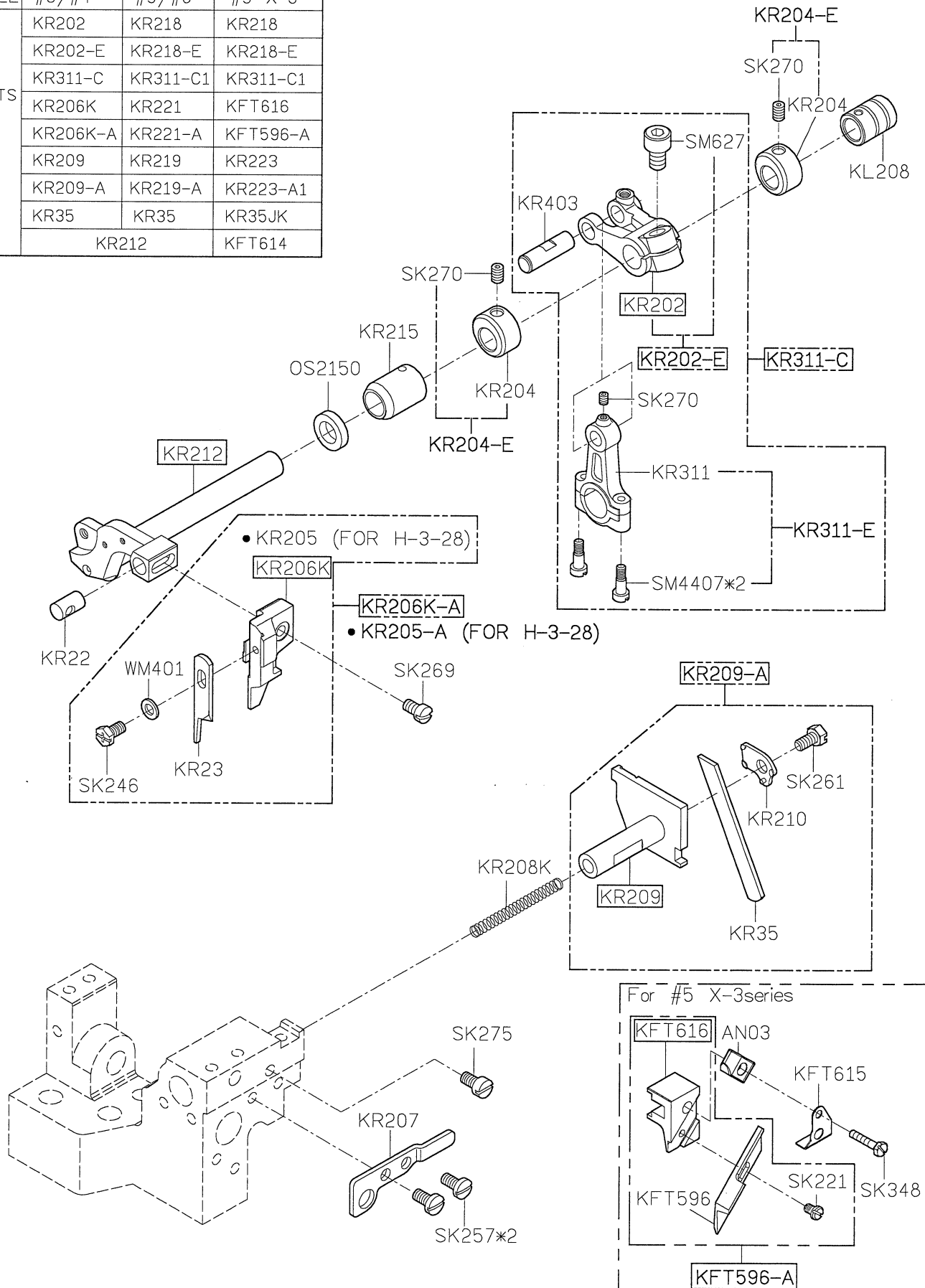

1

2

3

4

5

SIRUBA PARTS LIST	Series	Parts Group	Subclass / Remark	Page
	700L	KS		1/1
				Date
				2020/11/09

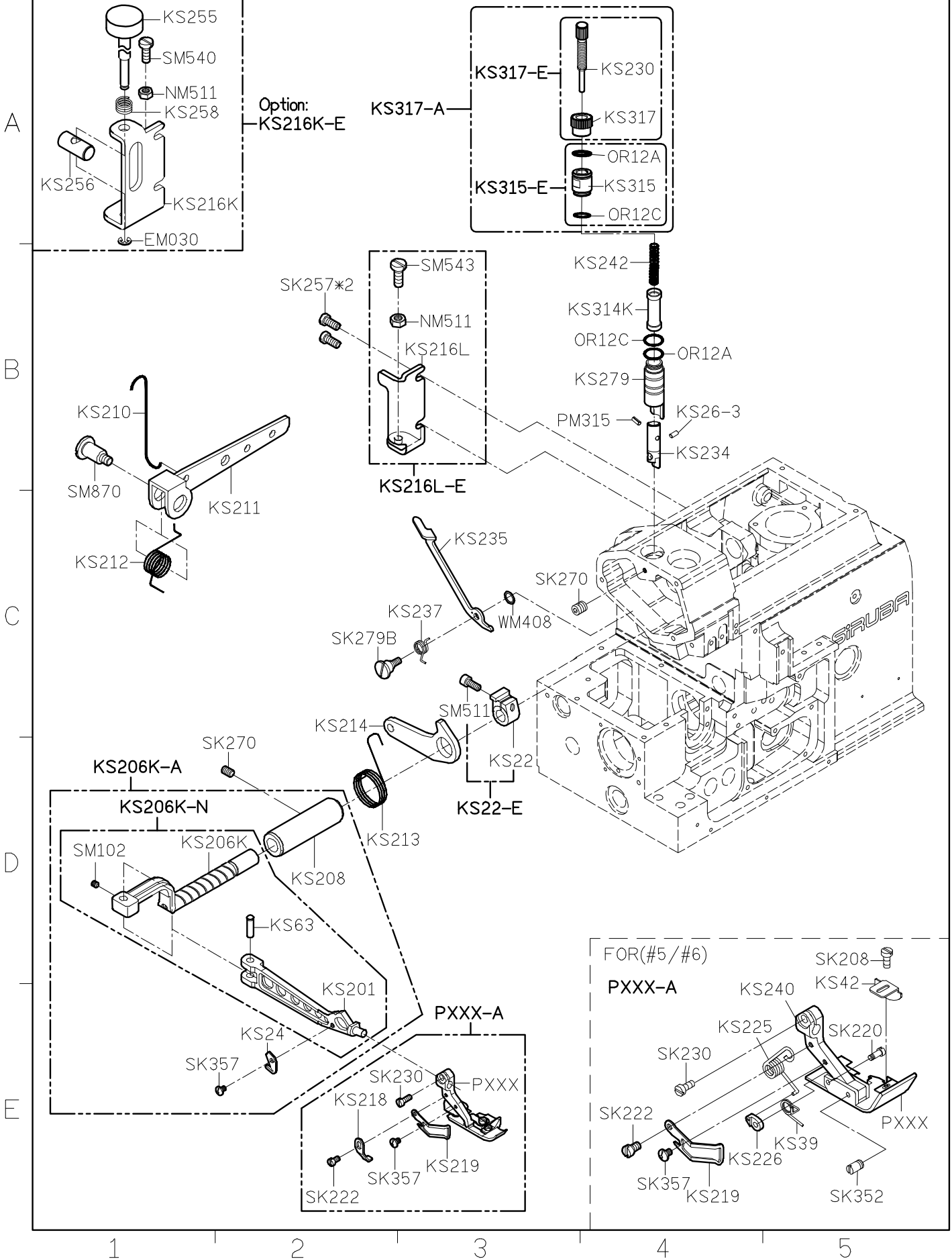

SIRUBA PARTS LIST	Series	Parts Group	Subclass / Remark	Page
	700L	KT		1/1
				Date
				2018/10/04

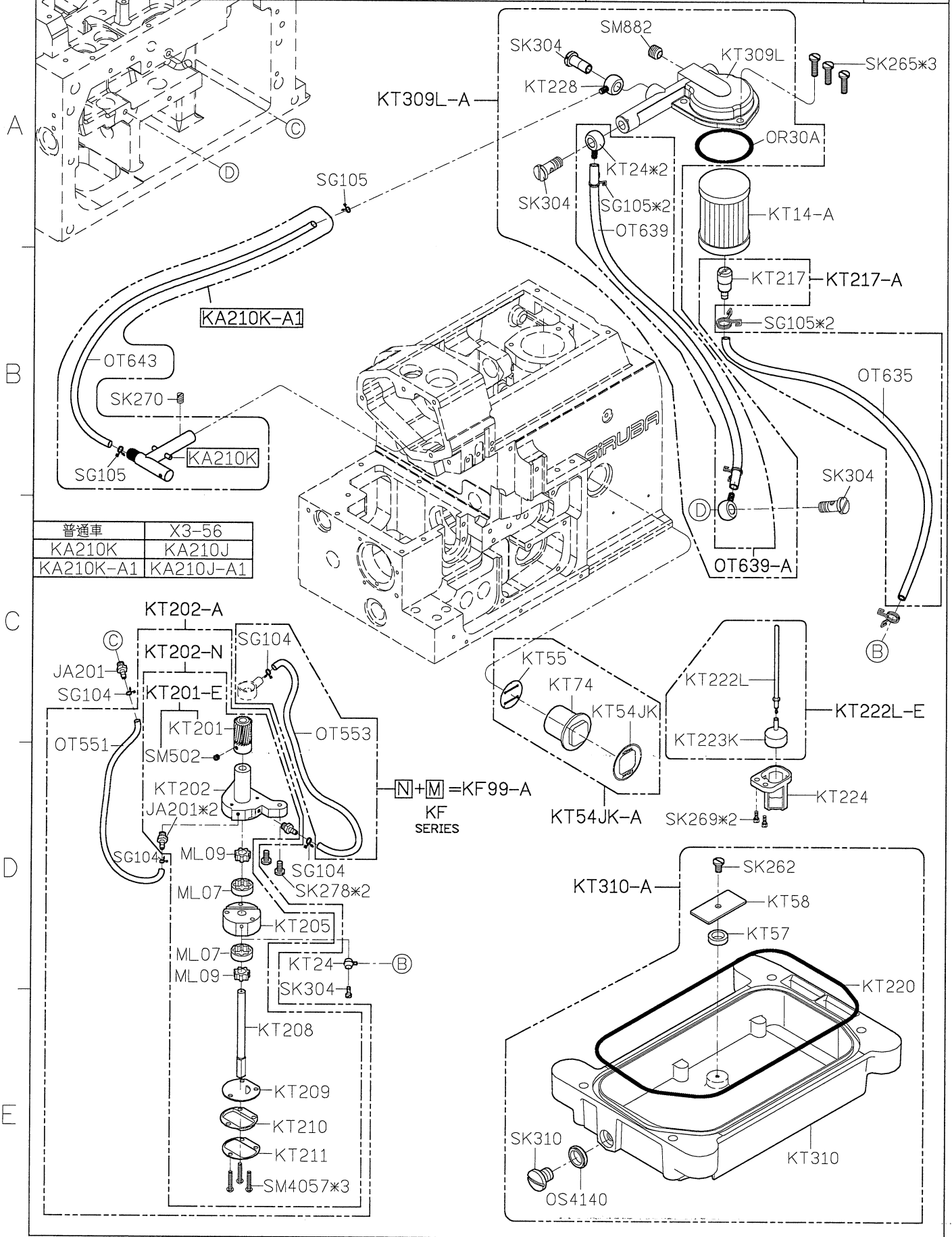

普通車	X3-56
KA210K	KA210J
KA210K-A1	KA210J-A1

MODEL	#3/#4	#5/#6
PARTS NO	KU40	KU39
	KU220-4	KU220-5
	KU207	KU209
	KU206	KU211
	KU203-4	KU203-5
	SK277	SK437

KU60-A
(FOR 505F1-04)

A

B

C

D

E

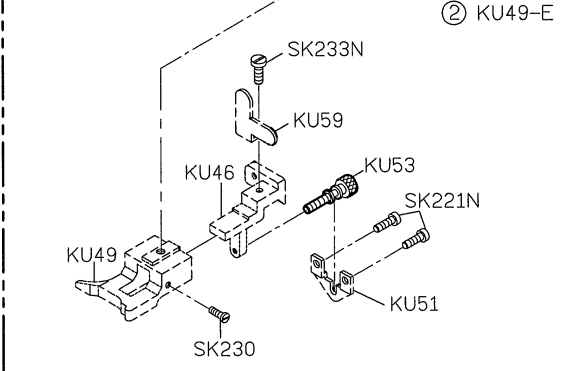
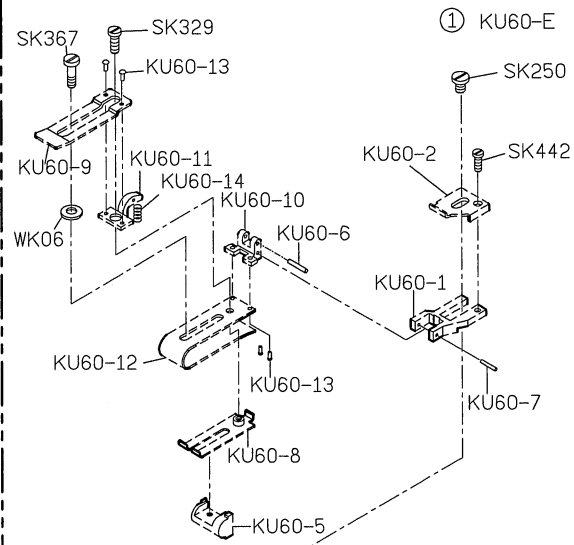
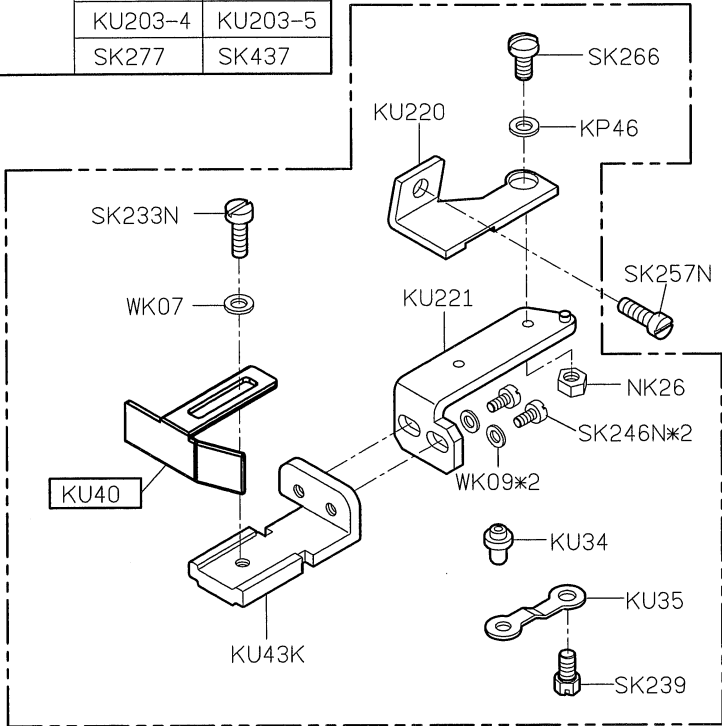

Option: **KU220-4**

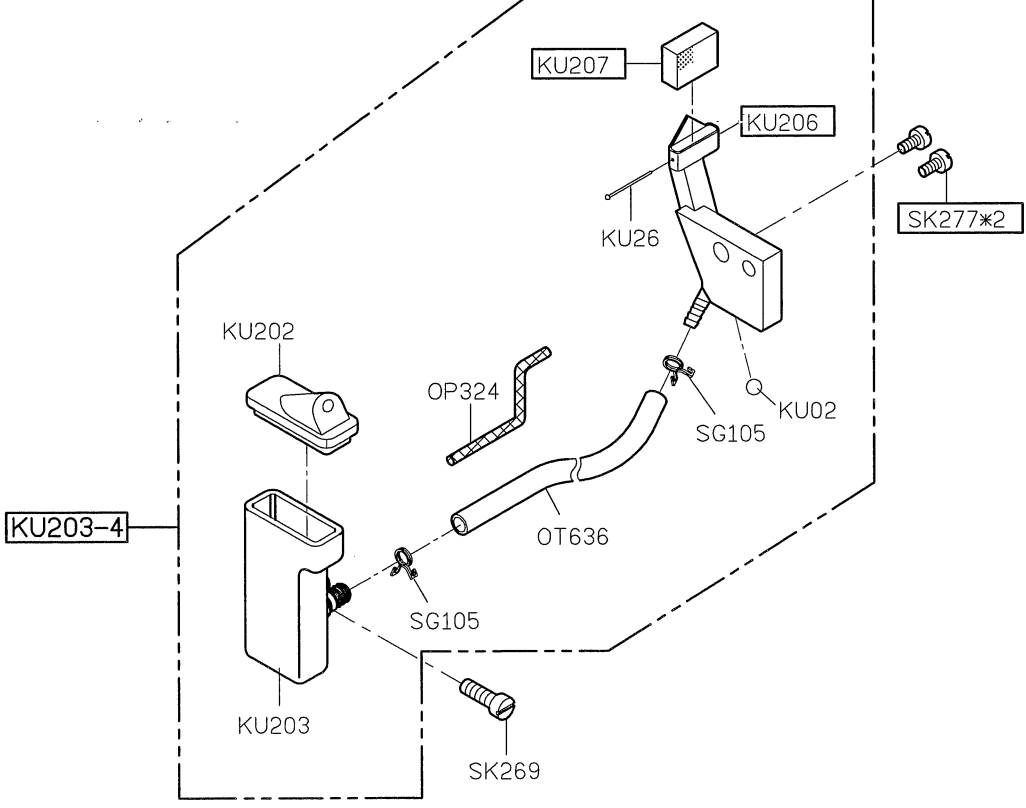

KW40E-3

A

B

C

D

E

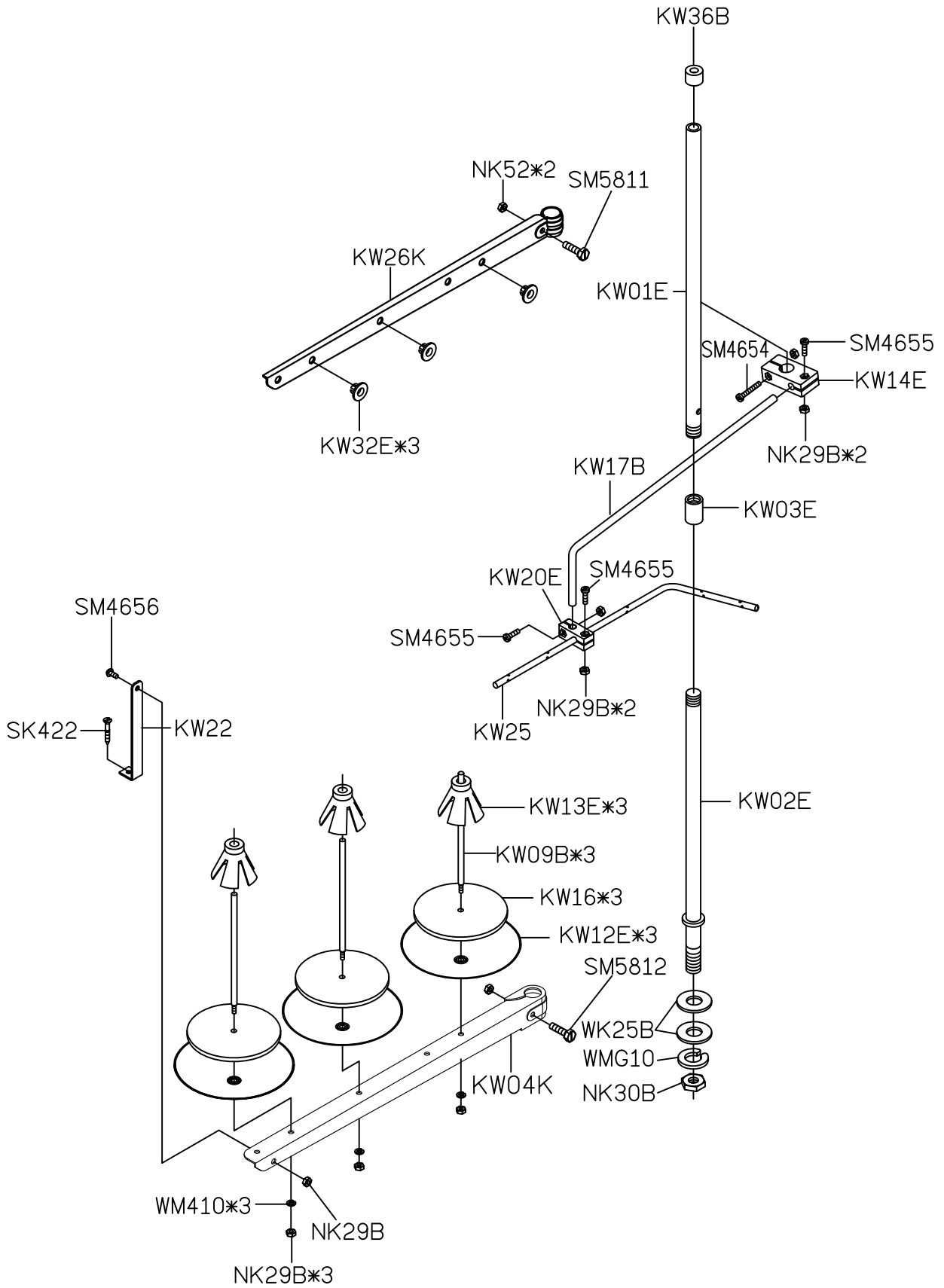

1

2

3

4

5

KW40E-4

A

B

C

D

E

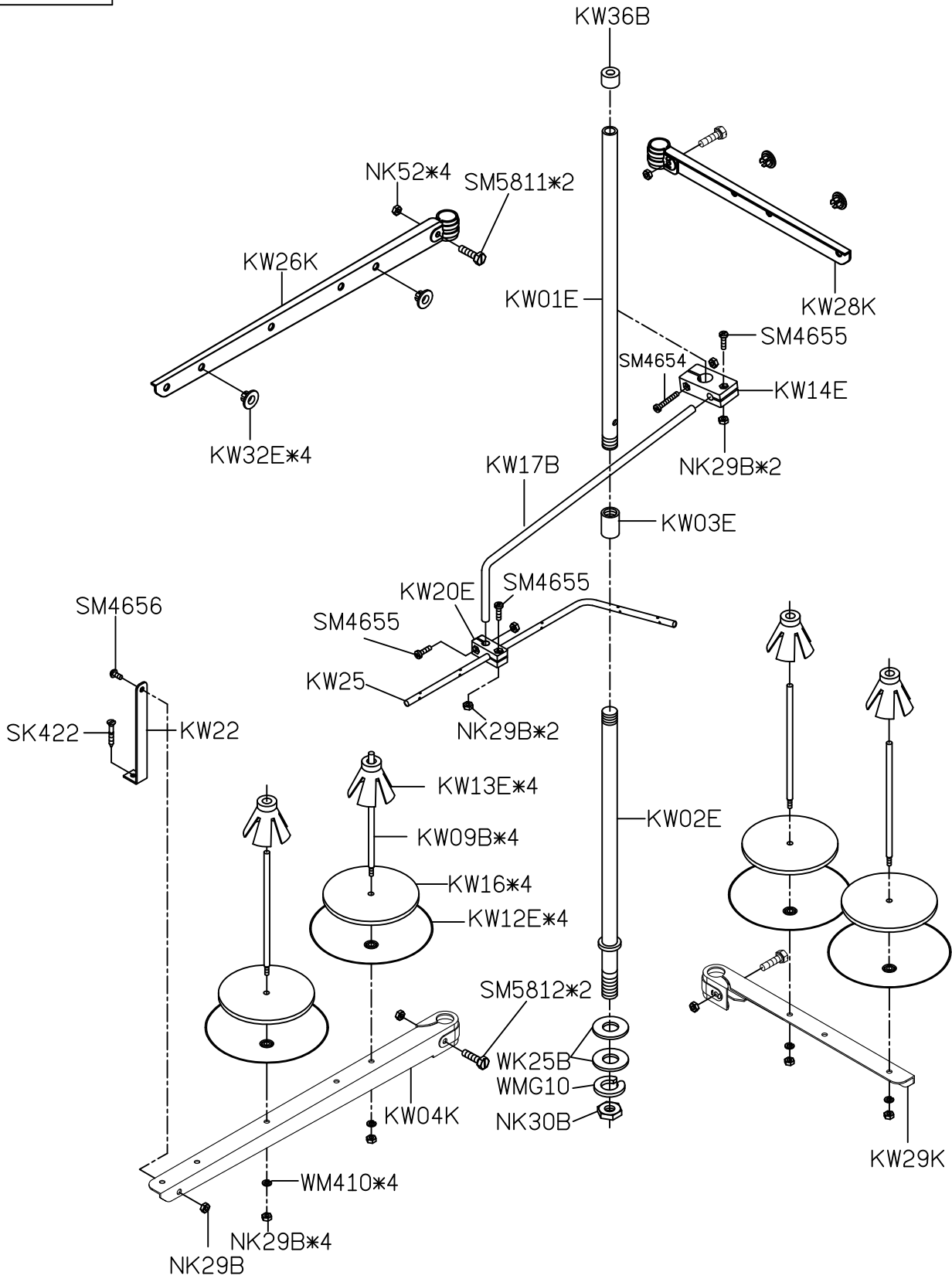

1

2

3

4

5

KW40E-5

A

B

C

D

E

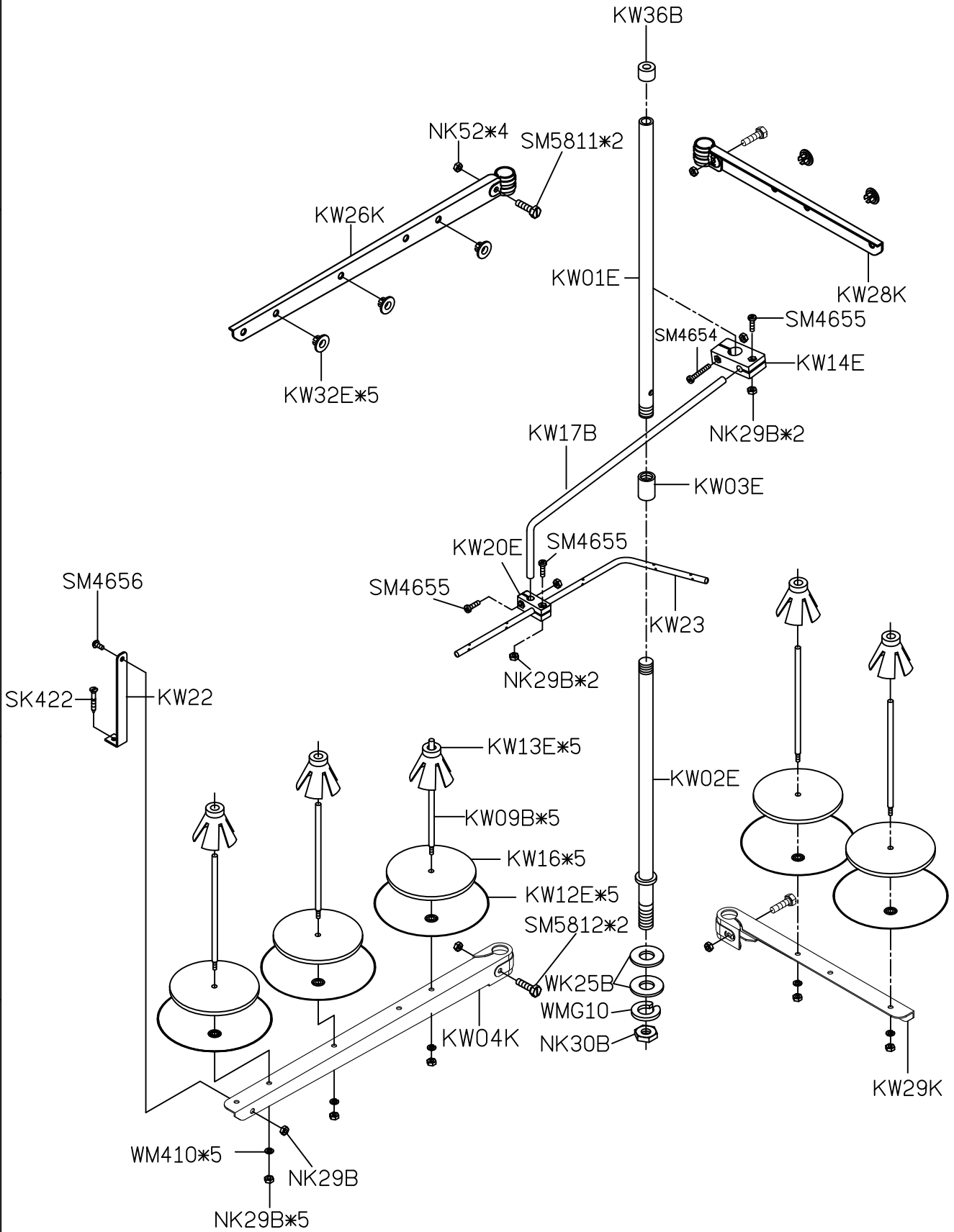

1

2

3

4

5

KW40E-6

A

B

C

D

E

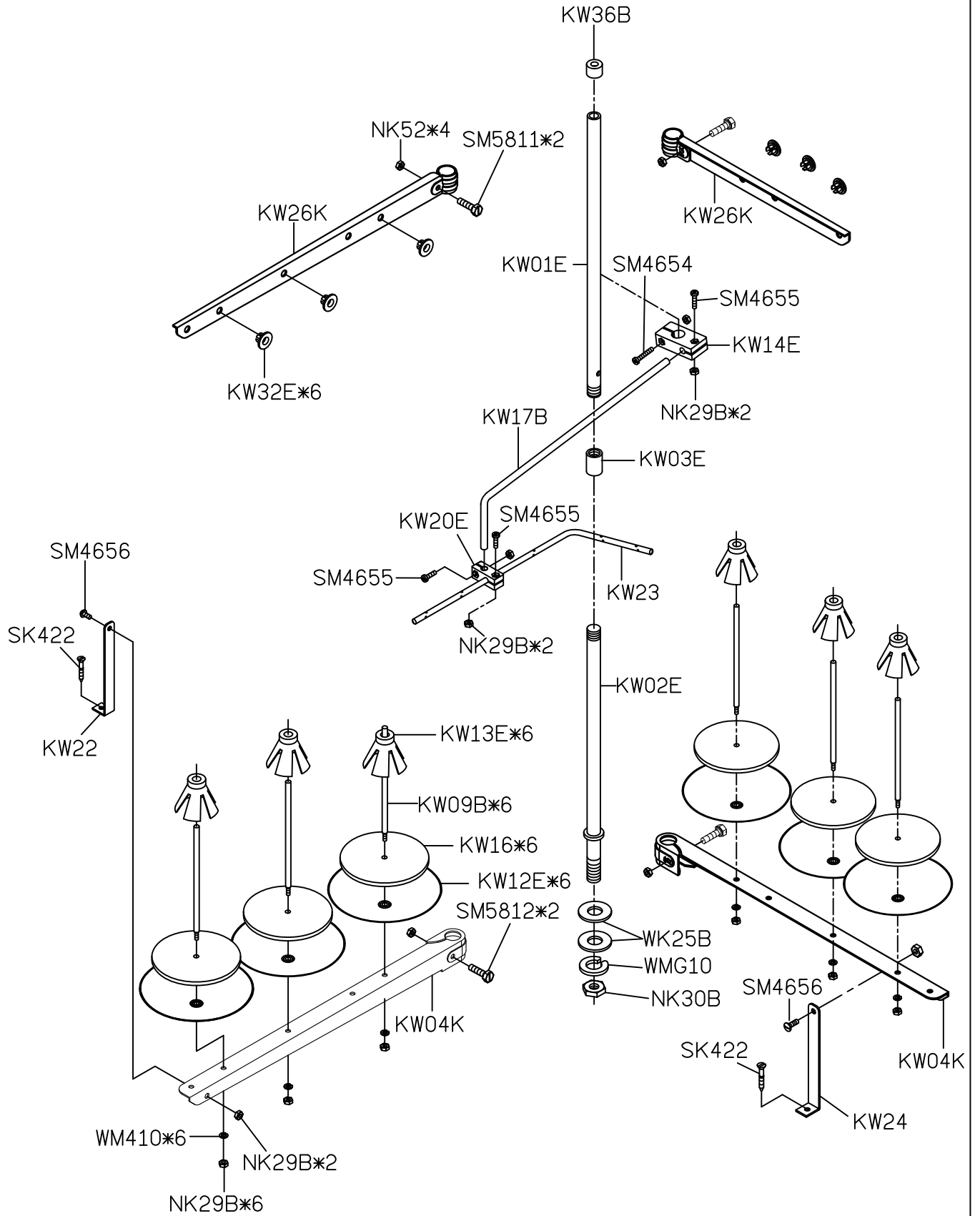

1

2

3

4

5

A

B

C

D

E

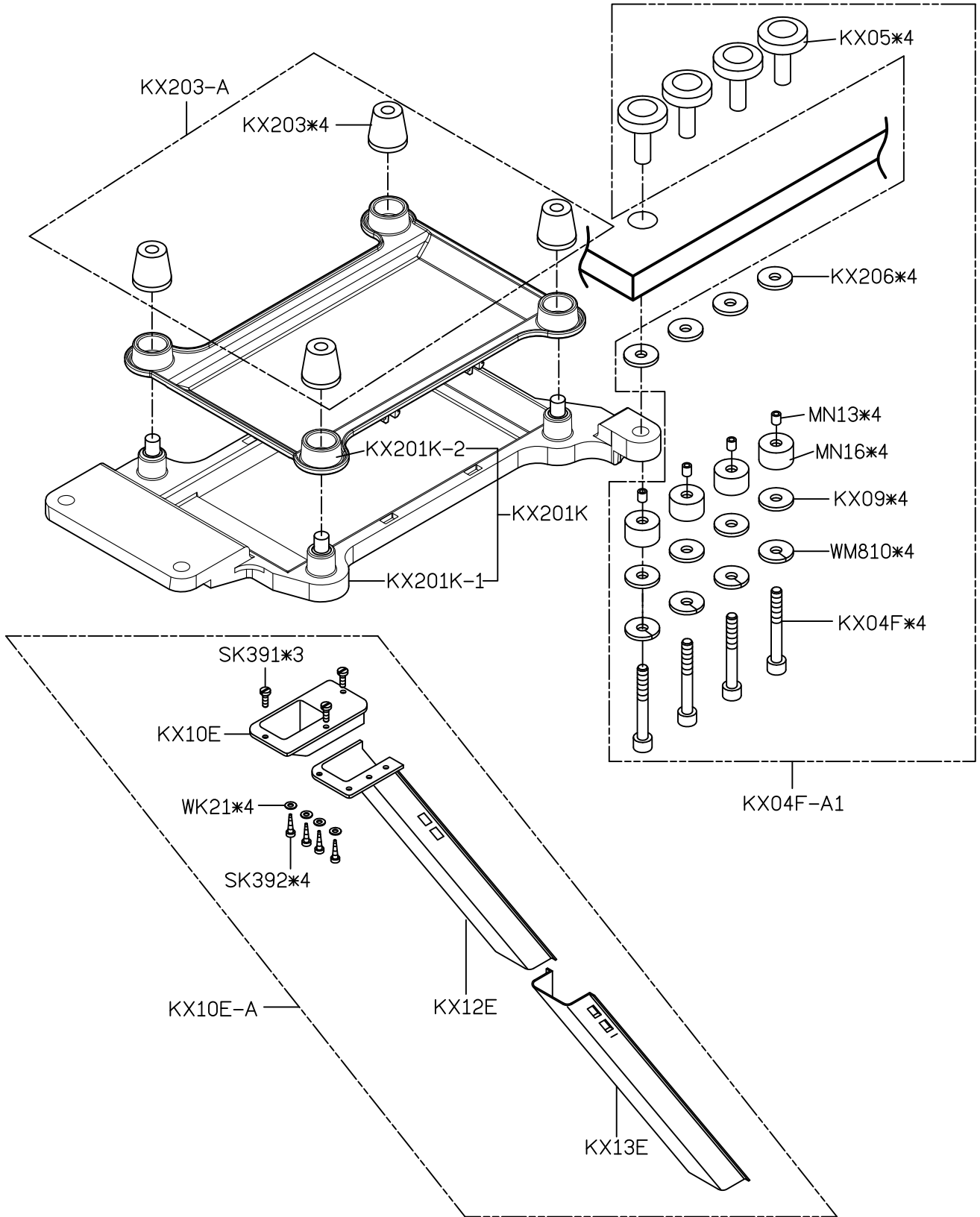

1









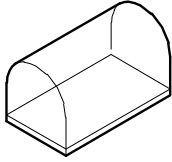

2

3

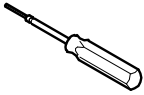
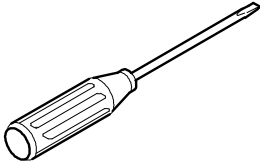
4

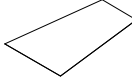
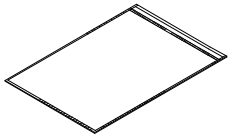
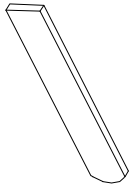
5

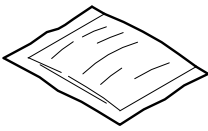
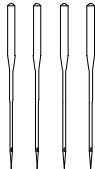
SIRUBA PARTS LIST	Series	Parts Group	Subclass Remark	Page
	700L	KY		1/1
				Date
				2020/12/01

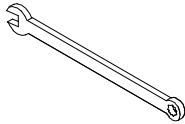
A	KY01-1 防塵罩 	KY203-A 油罐 	KY03 油壺 	KY04 漏斗 	SK216 螺絲 
B	KY14 內六角螺絲起子 	LY33 一字起子 	KY18 鑷子 	KY30 針板紙 	KY201JK 工具袋 
C	KR35 下刀片 	KT14-A 濾油器 	KZ03 乾燥濟 	針*4 車針 	KY21-A/MY21-A 鉤子/鍊條 
D	KY231 開口板手 				
E					
	1	2	3	4	5

A

B

C

D

E

KW40E

KX201K-2

KX201K-1

KX201K

KZ201-2

KZ26K-12

KZ27K-1

KZ209

KZ27K

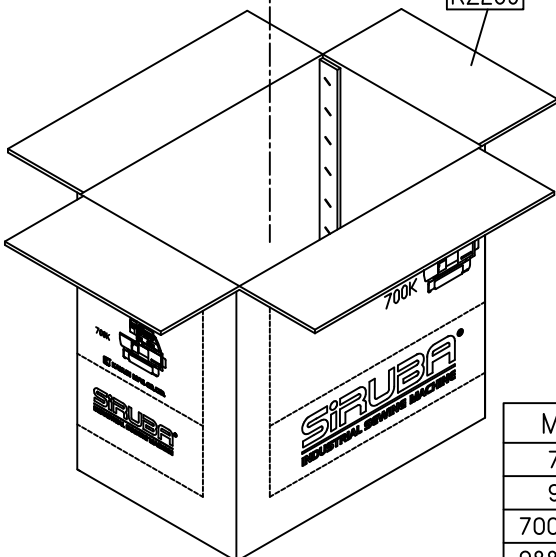

MODEL	PARTS NO		
700L	KZ209	KZ27K	KZ27K-1/KZ26K-12/KZ201-2
988L	KZ53P-1	KZ27K	KZ27K-1/KZ26K-12/KZ201-2
700L-LFC	KZ55P	KZ51K	KZ51K-1/KZ26K-2
988L-LFC	KZ55P-1	KZ51K	KZ51K-1/KZ26K-2

1

2

3

4

5

SIRUBA

TABLE
CUT - OUT

Series
700K/988
700KT/700L

Item Code
700K-T

Subclass Remark

Mounting
Semi-submerged
Date
2018/08/28

單位 / UNIT : mm
所有尺寸公差 / TOLERANCE : ±2
長度 (L) : 1070 / 重量 (W) : 10.5kg ± 5%
長度 (L) : 1200 / 重量 (W) : 11.5kg ± 5%

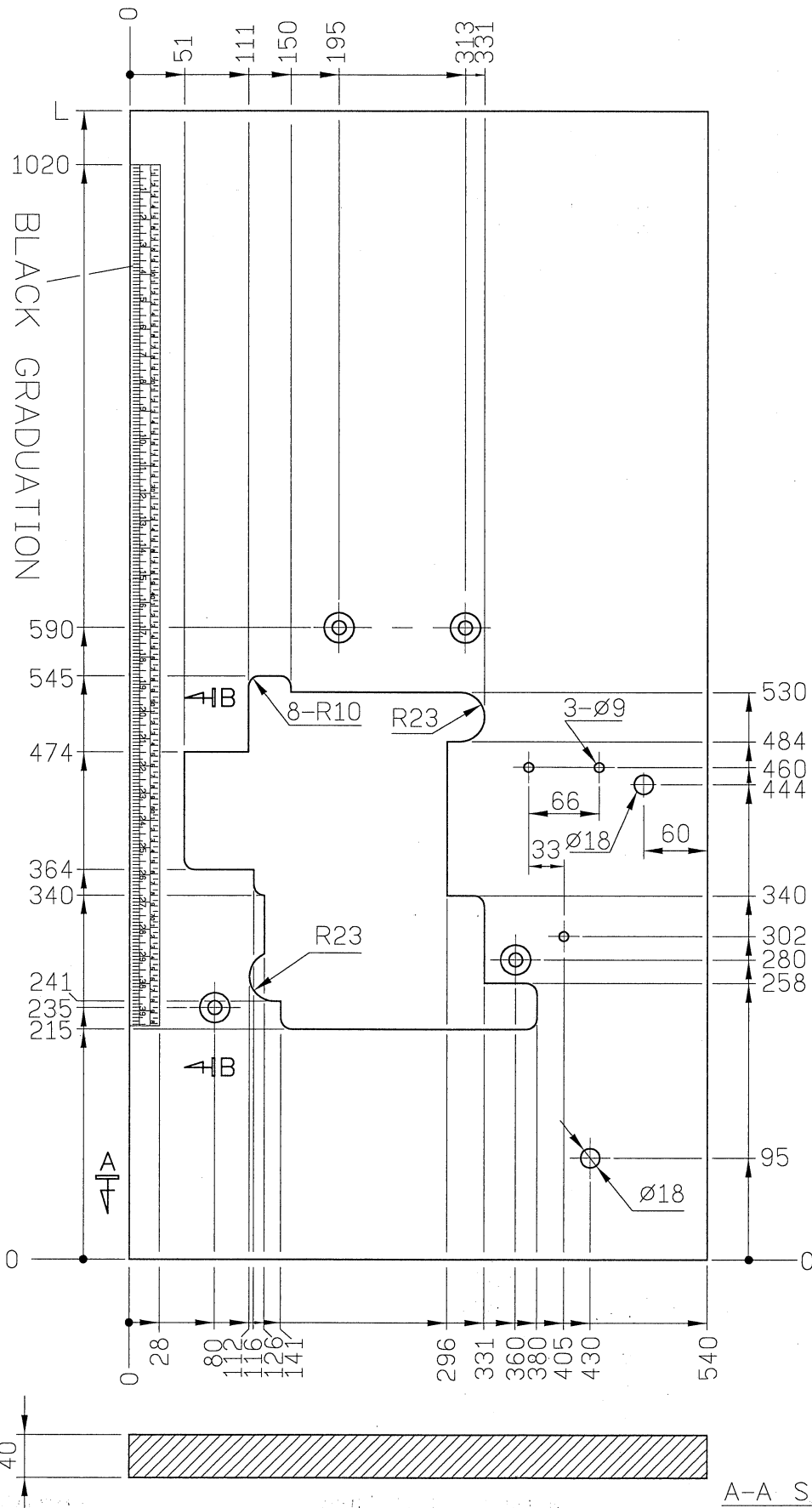

A-A SECTION

B-B SECTION

SIRUBA TABLE CUT - OUT	Series	Item Code	Subclass Remark	Mounting
	700K/988	700K-T2	需配TBK-1 (包含TB201) Collocate With TBK-1 (Including TB201)	Fully-submerged
	700L			Date
				2018/08/28

單位 / UNIT: mm
 所有尺寸公差 / TOLERANCE: ±2
 重量 (W): 12.4kg ±5%

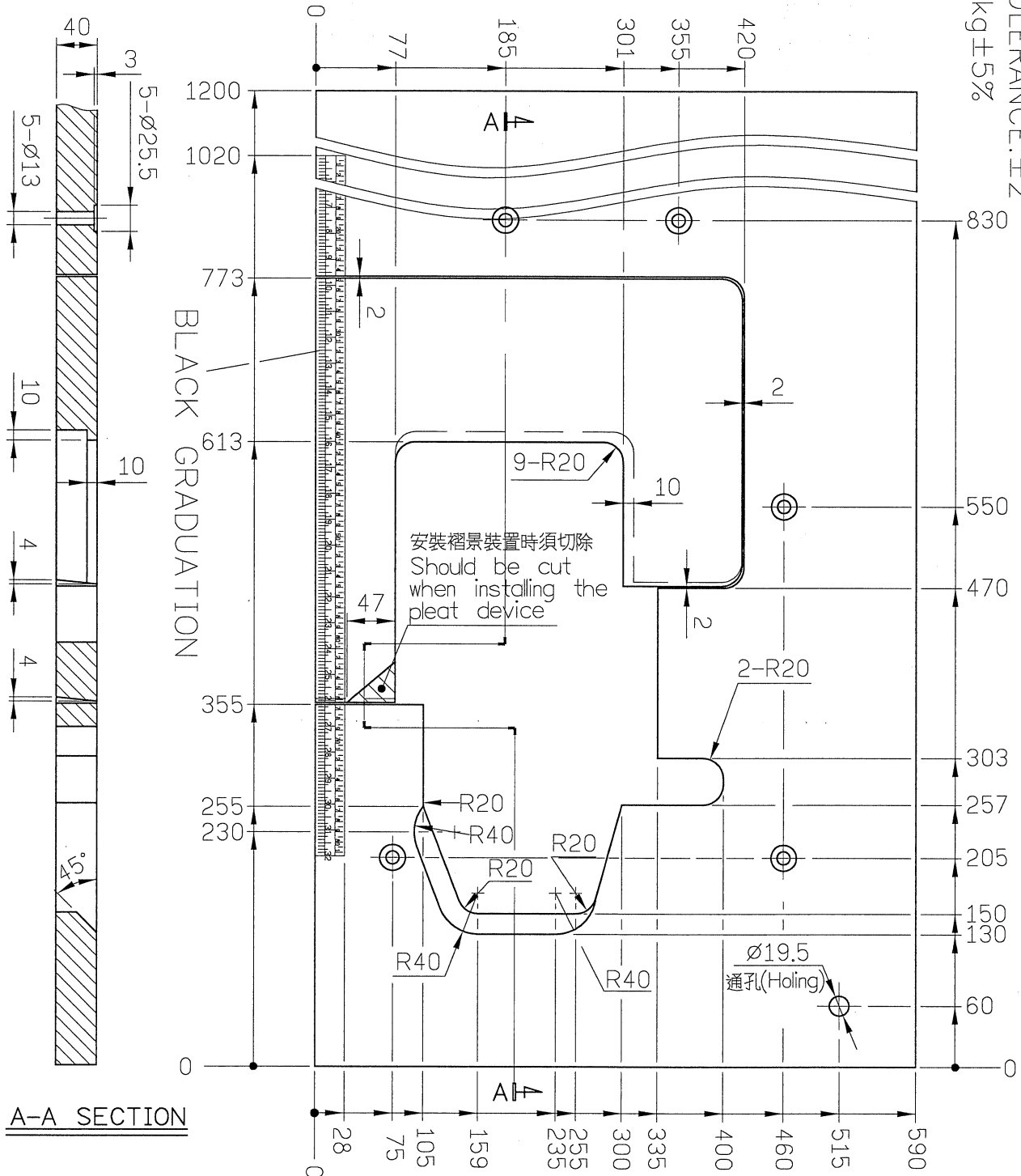

SIRUBA

TABLE
CUT - OUT

Series
700K/988
700L

Item Code
700K-T3

Subclass Remark
For:EC.CT.VT
需配TBK-1(包含TB201)
Collocate With
TBK-1(Including TB201)

Mounting
Fully-submerged
Date
2018/08/28

單位 / UNIT: mm
所有尺寸公差 / TOLERANCE: ±2
重量 (W): 12.4kg ±5%

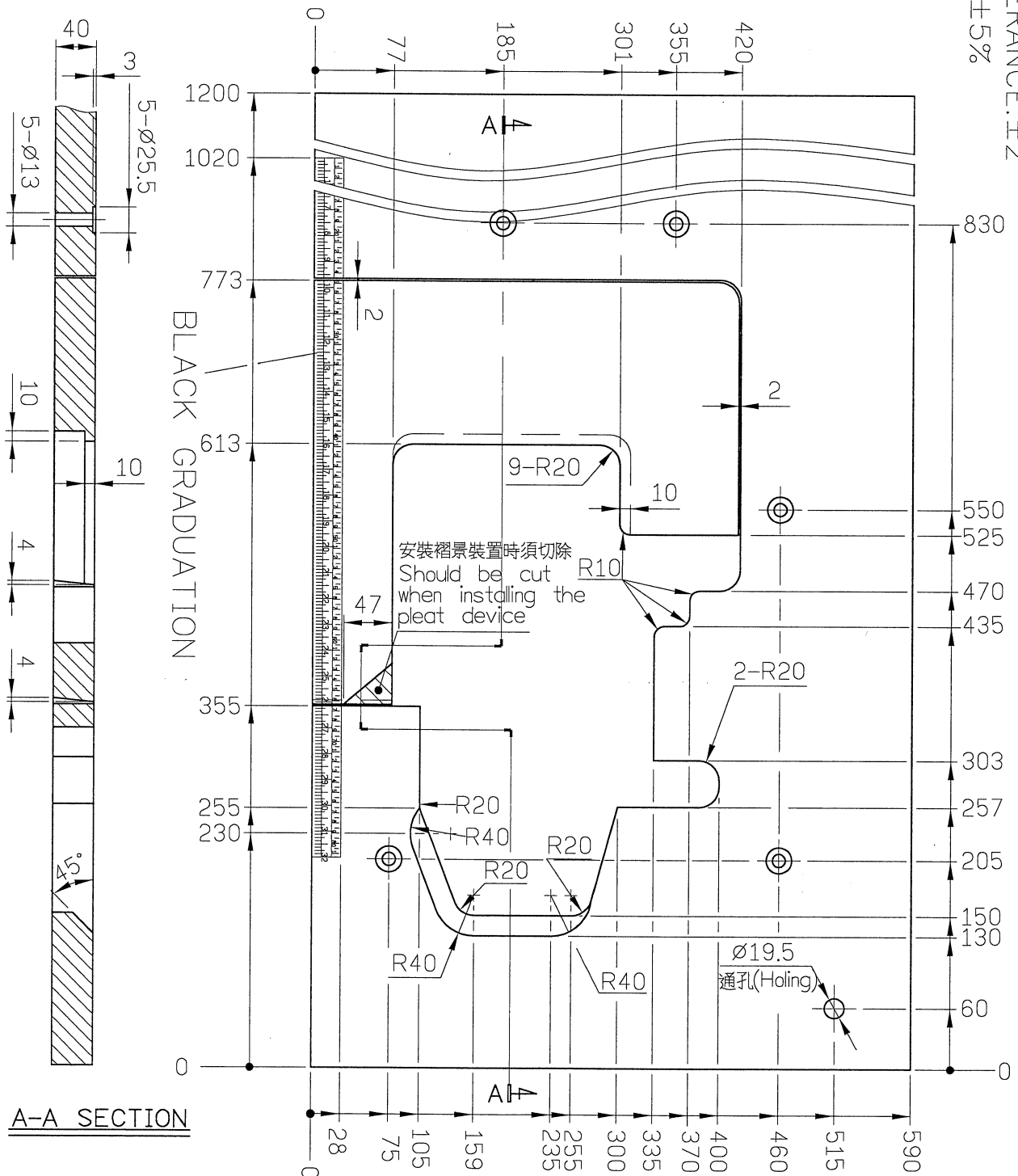

A-A SECTION

SIRUBA

TABLE
CUT - OUT

Series

700K/988

700L

Item Code

TB201

Subclass Remark

Mounting

Fully-submerged
Fixed Table

Date

2018/08/28

單位/UNIT:mm

所有尺寸公差/DIFFERENCE:±2

重量(W):4.25kg±5%

全封邊灰格紋光塑面台板/Plastic Table With All Sides Sealed With Gray Plaid

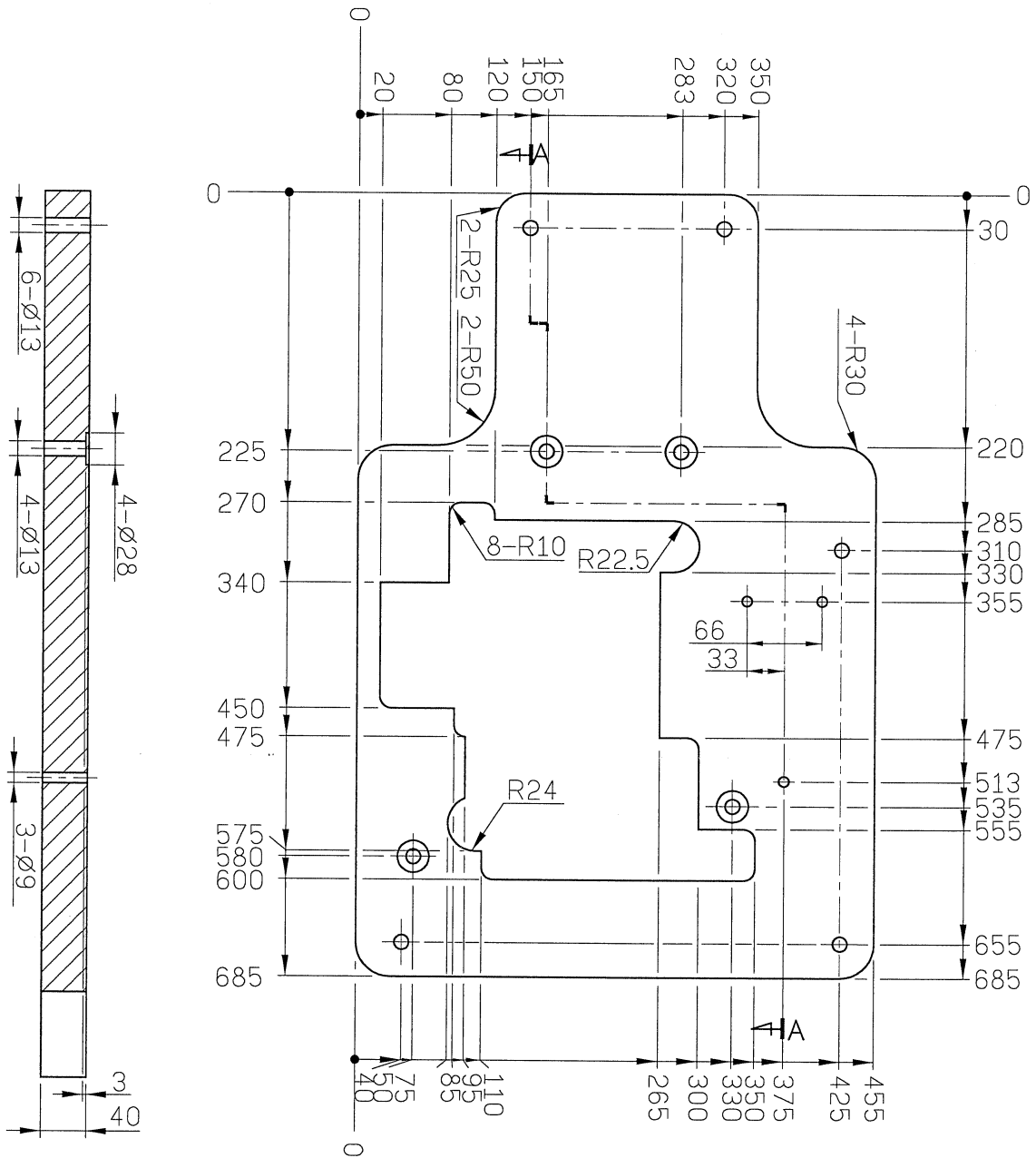

A-A SECTION

SIRUBA

TABLE
CUT - OUT

Series	700K/988/700KT 700L/700LD
--------	------------------------------

Item Code	700LD-T
-----------	---------

Subclass Remark	FOR 直驅用
-----------------	---------

Mounting	Semi-submerged
Date	2018/08/31

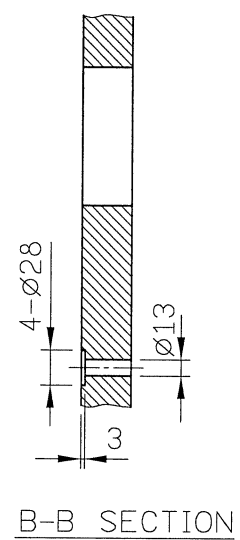
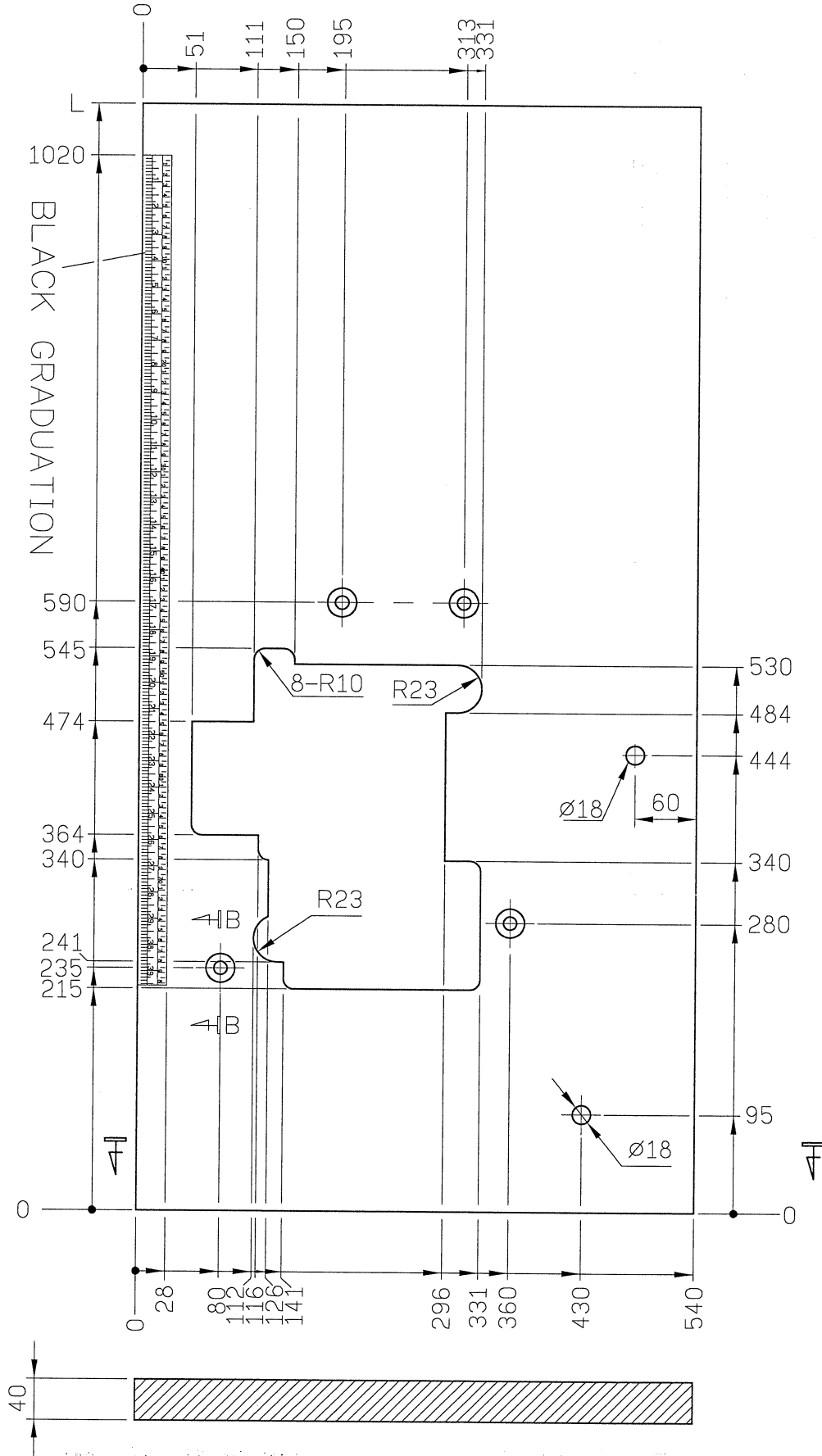

單位 / UNIT: mm
 所有尺寸公差 / TOLERANCE: ± 2
 長度 (L): 1200
 重量 (W): 11.5Kg $\pm 5\%$

B-B SECTION