

SOLID: LINE MIDBAY EMERGENCY LIGHTS

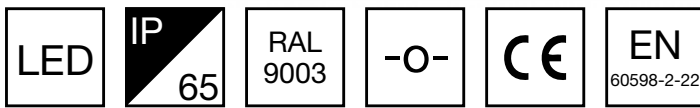

Solid Line Midbay is designed for escape route emergency lighting. The luminaire is completely dust proof and water proof, so it is suitable for example for industrial premises, parking halls, as well as for outdoor use

The Solid luminaire uses long-lasting LEDs as its light source.

Special attention has been paid to the design, for easy installation.

The product codes starting with letter Y include an individually packed luminaire. The product codes starting with TW include the luminaire only.

SELF-CONTAINED ESCAP EMERGENCY LIGHTS WITH SUPER CAPACITOR AND SELF-TESTING

Product Code	Nominal Supply Voltage	Feature	Backup (h)	Form
TWS4392WM	220-240 V, 50/60 Hz AC	Escap, Lumi Test	1	
Y4392WM	220-240 V, 50/60 Hz AC	Escap, Lumi Test	1	

SELF-CONTAINED ESCAP EMERGENCY LIGHTS WITH SUPER CAPACITOR AND WIRELESS CENTRAL MONITORING

Product Code	Nominal Supply Voltage	Feature	Backup (h)
TWS4392WA	220-240 V, 50/60 Hz AC	Aalto Control, Escap, Lumi Test	1
Y4392WA	220-240 V, 50/60 Hz AC	Aalto Control, Escap, Lumi Test	1

We reserve the rights to make modifications without notice.
Copyright © 2021 Teknoware. All rights reserved.
Date: February 15, 2021 | Source:
www.teknoware.com/en/emergency-lighting/emergency-lights/emergency-light-product-families/solid-line-midbay-emergency-lights



SELF-CONTAINED EMERGENCY LIGHTS WITH BATTERY AND SELF-TESTING

Product Code	Nominal Supply Voltage	Feature	Backup (h)
TWT4352WM	220-240 V, 50/60 Hz AC	Lumi Test	1
Y4352WM	220-240 V, 50/60 Hz AC	Lumi Test	1
TWT4353WM	220-240 V, 50/60 Hz AC	Lumi Test	3
Y4353WM	220-240 V, 50/60 Hz AC	Lumi Test	3

SELF-CONTAINED EMERGENCY LIGHTS WITH BATTERY AND WIRELESS CENTRAL MONITORING

Product Code	Nominal Supply Voltage	Feature	Backup (h)
TWT4352WA	220-240 V, 50/60 Hz AC	Aalto Control, Lumi Test	1
Y4352WA	220-240 V, 50/60 Hz AC	Aalto Control, Lumi Test	1
TWT4353WA	220-240 V, 50/60 Hz AC	Aalto Control, Lumi Test	3
Y4353WA	220-240 V, 50/60 Hz AC	Aalto Control, Lumi Test	3

ADDRESSABLE 230 V CENTRALLY SUPPLIED EMERGENCY LIGHTS

Product Code	Nominal Supply Voltage	Feature
TWT4351WKH	220-240 V, 50/60 Hz AC, DC	Intelligent Controller, Tapsa Control
TWT4351WK	220-240 V, 50/60 Hz AC, DC	Intelligent Controller, Tapsa Control
Y4351WK	220-240 V, 50/60 Hz AC, DC	Intelligent Controller, Tapsa Control

NON-ADDRESSABLE 230 V CENTRALLY SUPPLIED EMERGENCY LIGHTS

Product Code	Nominal Supply Voltage	Feature
TWT4371W	24-230 V, 50/60 Hz AC, DC	
Y4371W	24-230 V, 50/60 Hz AC, DC	

ADDRESSABLE 24 V CENTRALLY SUPPLIED EMERGENCY LIGHTS

Product Code	Nominal Supply Voltage	Feature
TWT4341WK	24 V, 50/60 Hz AC, DC	Tapsa Control

We reserve the rights to make modifications without notice.

Copyright © 2021 Teknoware. All rights reserved.

Date: February 15, 2021 | Source:

www.teknoware.com/en/emergency-lighting/emergency-lights/emergency-light-product-families/solid-line-midbay-emergency-lights



SOLID LINE MIDBAY EMERGENCY LIGHT TWS4392WA

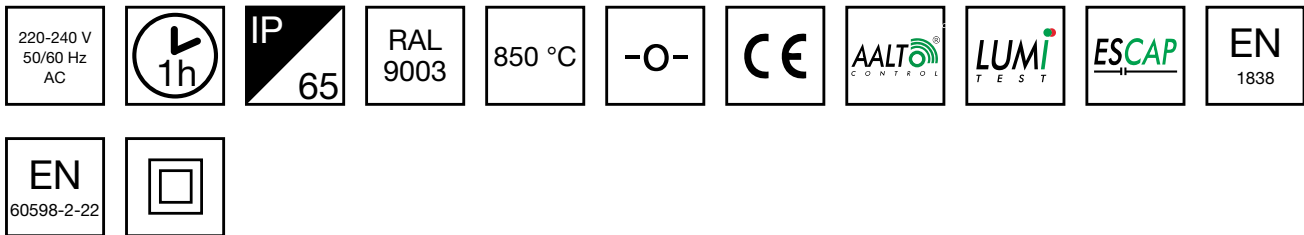

Self-contained ESCAP Emergency Light with 1 h Super Capacitor and Wireless Central Monitoring

Solid Line Midbay is designed for escape route emergency lighting. The luminaire is completely dust proof and water proof, so it is suitable for example for industrial premises and parking halls. ESCAP and centrally supplied luminaires are also suitable for outdoor use.

The Solid luminaire uses long lasting leds as its light source.

Special attention has been paid to the design, for easy installation.

INDIVIDUALLY PACKED LIGHTS

The product codes starting with letter Y include an individually packed luminaire. The product codes starting with TW include the luminaire only.

Product Code	IP Class	Luminous Flux (lm)
Y4392WA	IP65	92

Product Code	TWS4392WA
Feature	Aalto Control, Escap, Lumi Test
Mounting (standard)	surface
Customs Code	94056080
GTIN Code	6438045021171
ETIM Product Class	EC001957
Length	371 mm
Width	181 mm
Height	57 mm
Weight	1,5 kg
Backup	1 h
Max Input Power VA	3 VA
Nominal Supply Voltage	220-240 V, 50/60 Hz AC
Protection Class	II
IP Class	IP65
Temperature Range Min - Max	-25...+35 °C
Glow Wire Test of Plastic Materials	850 °C
Body Material	plastic
Colour	RAL9003
Electrical Installation	2/3 x 2,5 mm ²

We reserve the rights to make modifications without notice.
Copyright © 2021 Teknoware. All rights reserved.
Date: February 15, 2021 | Source:
www.teknoware.com/en/emergency-lighting/solid-line-midbay-emergency-light-tws4392wa

Teknoware Oy | P.O. Box 19, 15101 Lahti | Ilmarisentie 8, 15200 Lahti Finland
Tel +358 3 883 020 | VAT-number FI01494751 | teknoware.com | emexit@teknoware.com



Emergency lighting for escape routes (ceiling mounting)

Table of 1 lux for escape routes in the middle line according to the norm EN 1838.

Level of measurement 0,02 m, measurement result with battery operation.

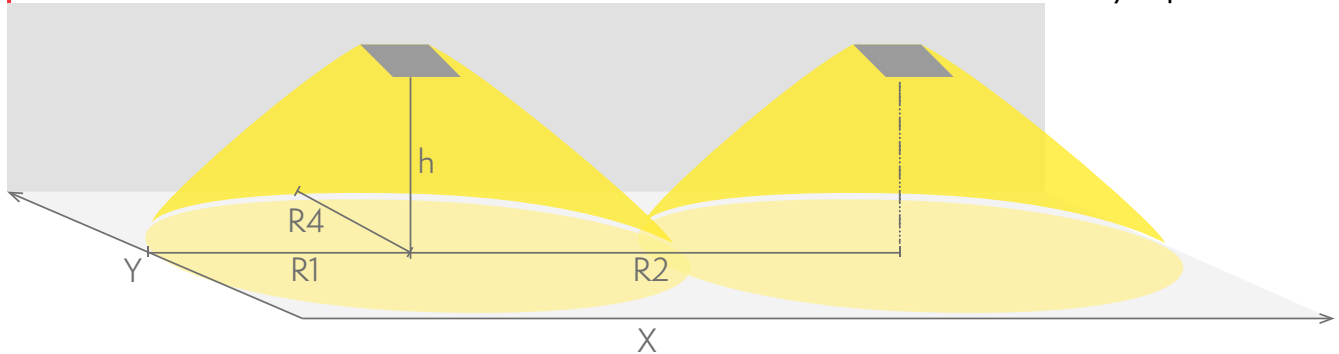

R1 distance from wall (X axis)

R2 installation distance between lights (X axis)

R4 distance from wall (Y axis)

TWS4392WA

Mounting height (m)	Below the light lux	R1 (m)	R2 (m)	R4 (m)
		1 lux	1 lux	1 lux
2,5	17	3,5	9	1
3	12	4	10	1
4	6,5	4	11	1
6	2,5	5	12	1
8	1,5	4	12	1

OPTIONAL ACCESSORIES:

OPTIONAL MOUNTING ACCESSORIES FOR EMERGENCY EXIT LIGHTS



Product Code	Product Name	Compatible Product Groups
TWT3006	Solid Suspension Bracket TWT3006	Solid Exit 2 Emergency Exit Lights, Solid: Line Lowbay Emergency Lights, Solid: Line Midbay Emergency Lights, Solid: Zone Lowbay Emergency Lights, Solid: Zone Midbay Emergency Lights

We reserve the rights to make modifications without notice.

Copyright © 2021 Teknoware. All rights reserved.

Date: February 15, 2021 | Source:

www.teknoware.com/en/emergency-lighting/solid-line-midbay-emergency-light-tws4392wa

Teknoware Oy | P.O. Box 19, 15101 Lahti | Ilmarisentie 8, 15200 Lahti Finland

Tel +358 3 883 020 | VAT-number FI01494751 | teknoware.com | emexit@teknoware.com

COMPATIBLE PRODUCTS:

OPTIONAL MOUNTING ACCESSORIES FOR EMERGENCY EXIT LIGHTS



Product Code	Product Name	Compatible Product Groups
TWT3006	Solid Suspension Bracket TWT3006	Solid Exit 2 Emergency Exit Lights, Solid: Line Lowbay Emergency Lights, Solid: Line Midbay Emergency Lights, Solid: Zone Lowbay Emergency Lights, Solid: Zone Midbay Emergency Lights
TWT3001	Solid Recess Mounting Frame TWT3001	Solid Exit Emergency Exit Lights, Solid Exit 2 Emergency Exit Lights, Solid: Line Lowbay Emergency Lights, Solid: Line Midbay Emergency Lights, Solid: Zone Lowbay Emergency Lights, Solid: Zone Midbay Emergency Lights
TWT3002	Solid Wall bracket TWT3002	Solid Exit Emergency Exit Lights, Solid Exit 2 Emergency Exit Lights, Solid: Line Lowbay Emergency Lights, Solid: Line Midbay Emergency Lights, Solid: Zone Lowbay Emergency Lights, Solid: Zone Midbay Emergency Lights
TWT3003	Solid Flag bracket TWT3003	Solid Exit Emergency Exit Lights, Solid Exit 2 Emergency Exit Lights, Solid: Line Lowbay Emergency Lights, Solid: Line Midbay Emergency Lights, Solid: Zone Lowbay Emergency Lights, Solid: Zone Midbay Emergency Lights
TWT3004	Solid Ceiling bracket TWT3004	Solid Exit Emergency Exit Lights, Solid Exit 2 Emergency Exit Lights, Solid: Line Lowbay Emergency Lights, Solid: Line Midbay Emergency Lights, Solid: Zone Lowbay Emergency Lights, Solid: Zone Midbay Emergency Lights

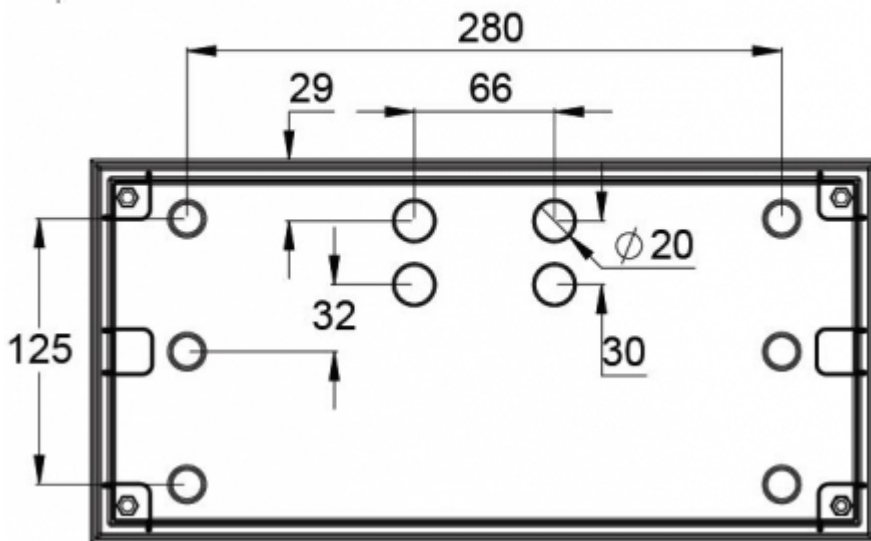
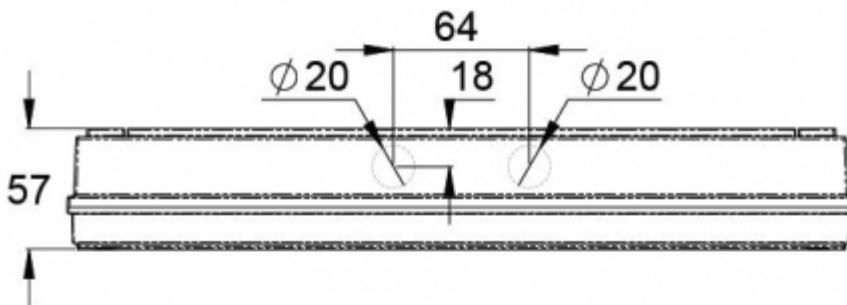
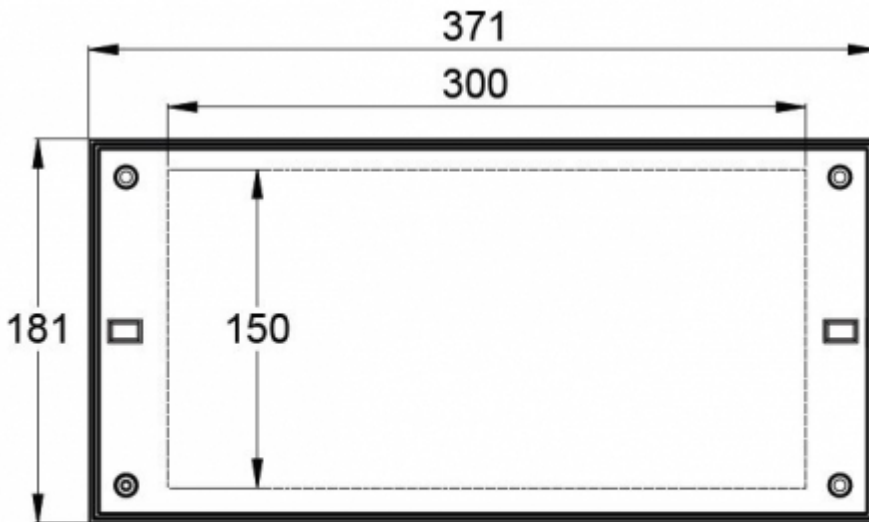

We reserve the rights to make modifications without notice.
 Copyright © 2021 Teknoware. All rights reserved.
 Date: February 15, 2021 | Source:
www.teknoware.com/en/emergency-lighting/solid-line-midbay-emergency-light-tws4392wa

Teknoware Oy | P.O. Box 19, 15101 Lahti | Ilmarisentie 8, 15200 Lahti Finland
 Tel +358 3 883 020 | VAT-number FI01494751 | teknoware.com | emexit@teknoware.com



SOLID LINE MIDBAY EMERGENCY LIGHT TWS4392WM

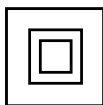
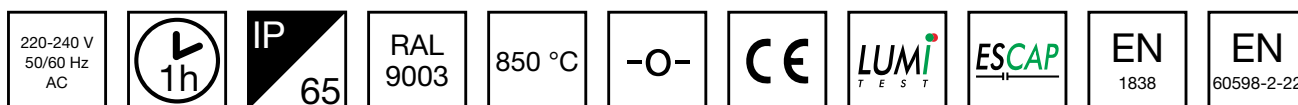

Self-contained ESCAP Emergency Light with 1 h Super Capacitor and Lumi Test Self-testing

Solid Line Midbay is designed for escape route emergency lighting. The luminaire is completely dust proof and water proof, so it is suitable for example for industrial premises and parking halls. ESCAP and centrally supplied luminaires are also suitable for outdoor use.

The Solid luminaire uses long lasting leds as its light source.

Special attention has been paid to the design, for easy installation.

INDIVIDUALLY PACKED LIGHTS

The product codes starting with letter Y include an individually packed luminaire. The product codes starting with TW include the luminaire only.

Product Code	IP Class	Luminous Flux (lm)
Y4392WM	IP65	92

Product Code	TWS4392WM
Feature	Escap, Lumi Test
Mounting (standard)	surface
Customs Code	94056080
GTIN Code	6438045021164
ETIM Product Class	EC001957
Length	371 mm
Width	181 mm
Height	57 mm
Weight	1,5 kg
Backup	1 h
Max Input Power VA	3 VA
Nominal Supply Voltage	220-240 V, 50/60 Hz AC
Protection Class	II
IP Class	IP65
Temperature Range Min - Max	-25...+35 °C
Glow Wire Test of Plastic Materials	850 °C
Body Material	plastic
Colour	RAL9003
Electrical Installation	2/3 x 2,5 mm ²

We reserve the rights to make modifications without notice.

Copyright © 2021 Teknoware. All rights reserved.

Date: February 15, 2021 | Source:

www.teknoware.com/en/emergency-lighting/solid-line-midbay-emergency-light-tws4392wm



Teknoware Oy | P.O. Box 19, 15101 Lahti | Ilmarisentie 8, 15200 Lahti Finland

Tel +358 3 883 020 | VAT-number FI01494751 | teknoware.com | emexit@teknoware.com

Emergency lighting for escape routes (ceiling mounting)

Table of 1 lux for escape routes in the middle line according to the norm EN 1838.

Level of measurement 0,02 m, measurement result with battery operation.

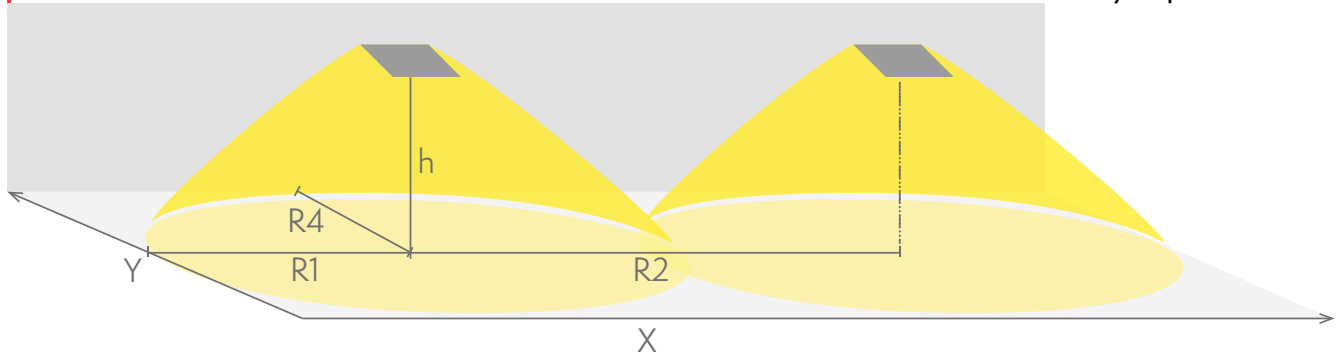

R1 distance from wall (X axis)

R2 installation distance between lights (X axis)

R4 distance from wall (Y axis)

TWS4392WM

Mounting height (m)	Below the light lux	R1 (m)	R2 (m)	R4 (m)
		1 lux	1 lux	1 lux
2,5	17	3,5	9	1
3	12	4	10	1
4	6,5	4	11	1
6	2,5	5	12	1
8	1,5	4	12	1

OPTIONAL ACCESSORIES:

OPTIONAL MOUNTING ACCESSORIES FOR EMERGENCY EXIT LIGHTS



Product Code	Product Name	Compatible Product Groups
TWT3006	Solid Suspension Bracket TWT3006	Solid Exit 2 Emergency Exit Lights, Solid: Line Lowbay Emergency Lights, Solid: Line Midbay Emergency Lights, Solid: Zone Lowbay Emergency Lights, Solid: Zone Midbay Emergency Lights

We reserve the rights to make modifications without notice.

Copyright © 2021 Teknoware. All rights reserved.

Date: February 15, 2021 | Source:

www.teknoware.com/en/emergency-lighting/solid-line-midbay-emergency-light-tws4392wm



Teknoware Oy | P.O. Box 19, 15101 Lahti | Ilmarisentie 8, 15200 Lahti Finland

Tel +358 3 883 020 | VAT-number FI01494751 | teknoware.com | emexit@teknoware.com

COMPATIBLE PRODUCTS:

OPTIONAL MOUNTING ACCESSORIES FOR EMERGENCY EXIT LIGHTS



Product Code	Product Name	Compatible Product Groups
TWT3006	Solid Suspension Bracket TWT3006	Solid Exit 2 Emergency Exit Lights, Solid: Line Lowbay Emergency Lights, Solid: Line Midbay Emergency Lights, Solid: Zone Lowbay Emergency Lights, Solid: Zone Midbay Emergency Lights
TWT3001	Solid Recess Mounting Frame TWT3001	Solid Exit Emergency Exit Lights, Solid Exit 2 Emergency Exit Lights, Solid: Line Lowbay Emergency Lights, Solid: Line Midbay Emergency Lights, Solid: Zone Lowbay Emergency Lights, Solid: Zone Midbay Emergency Lights
TWT3002	Solid Wall bracket TWT3002	Solid Exit Emergency Exit Lights, Solid Exit 2 Emergency Exit Lights, Solid: Line Lowbay Emergency Lights, Solid: Line Midbay Emergency Lights, Solid: Zone Lowbay Emergency Lights, Solid: Zone Midbay Emergency Lights
TWT3003	Solid Flag bracket TWT3003	Solid Exit Emergency Exit Lights, Solid Exit 2 Emergency Exit Lights, Solid: Line Lowbay Emergency Lights, Solid: Line Midbay Emergency Lights, Solid: Zone Lowbay Emergency Lights, Solid: Zone Midbay Emergency Lights
TWT3004	Solid Ceiling bracket TWT3004	Solid Exit Emergency Exit Lights, Solid Exit 2 Emergency Exit Lights, Solid: Line Lowbay Emergency Lights, Solid: Line Midbay Emergency Lights, Solid: Zone Lowbay Emergency Lights, Solid: Zone Midbay Emergency Lights

We reserve the rights to make modifications without notice.

Copyright © 2021 Teknoware. All rights reserved.

Date: February 15, 2021 | Source:

www.teknoware.com/en/emergency-lighting/solid-line-midbay-emergency-light-tws4392wm



Teknoware Oy | P.O. Box 19, 15101 Lahti | Ilmarisentie 8, 15200 Lahti Finland

Tel +358 3 883 020 | VAT-number FI01494751 | teknoware.com | emexit@teknoware.com

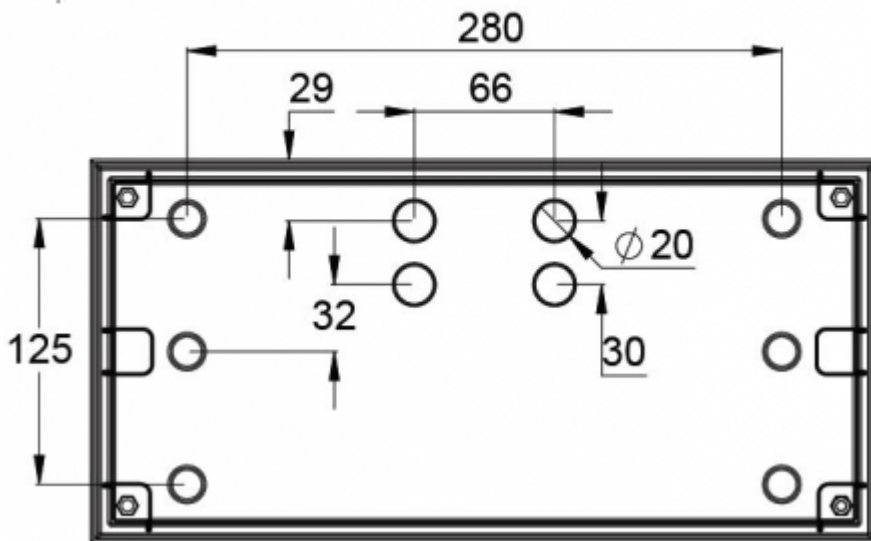
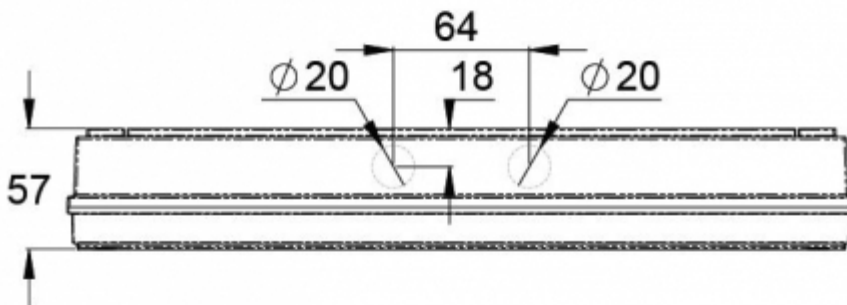
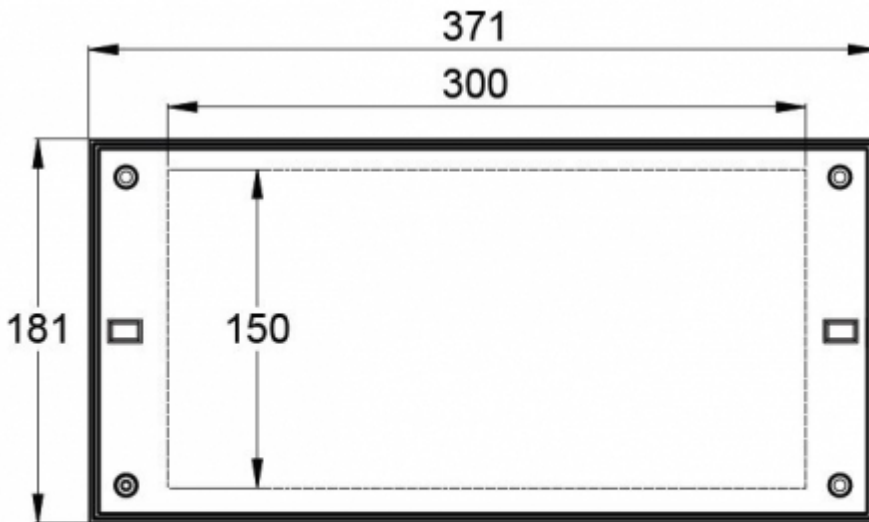

We reserve the rights to make modifications without notice.
 Copyright © 2021 Teknoware. All rights reserved.
 Date: February 15, 2021 | Source:
www.teknoware.com/en/emergency-lighting/solid-line-midbay-emergency-light-tws4392wm

Teknoware Oy | P.O. Box 19, 15101 Lahti | Ilmarisentie 8, 15200 Lahti Finland
 Tel +358 3 883 020 | VAT-number FI01494751 | teknoware.com | emexit@teknoware.com



SOLID LINE MIDBAY LED EMERGENCY LIGHT TWT4341WK

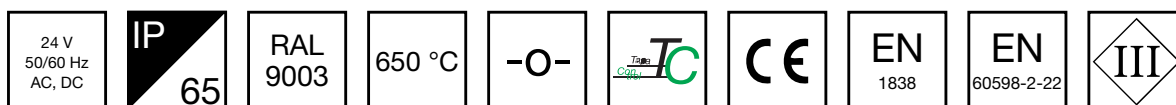

Addressable 24 V centrally supplied LED emergency light for escape routes

SOLID Line Midbay is designed for escape route emergency lighting. The luminaire is dust- and water proof, so it is suitable for example for industrial premises and parking halls. ESCAP and centrally supplied luminaires are also suitable for outdoor use.

The SOLID luminaire uses long lasting leds as its light source.

Special attention has been paid to the design, for easy installation.

Product Code	TWT4341WK
Feature	Tapsa Control
Mounting (standard)	surface
GTIN Code	6438045023915
Length	371 mm
Width	181 mm
Height	57 mm
Weight	1,1 kg
Max Input Power VA	3,4 VA
Max Input Power W	3,4 W
Nominal Supply Voltage	24 V, 50/60 Hz AC, DC
Protection Class	III
IP Class	IP65
Temperature Range Min - Max	-30...+50 °C
Glow Wire Test of Plastic Materials	650 °C
Body Material	plastic
Colour	RAL9003
Electrical Installation	2/3 x 2,5 mm ²
Luminous Flux	240 lm

Emergency lighting for escape routes (ceiling mounting)

Table of 1 lux for escape routes in the middle line according to the norm EN 1838.

Level of measurement 0,02 m, measurement result with battery operation.

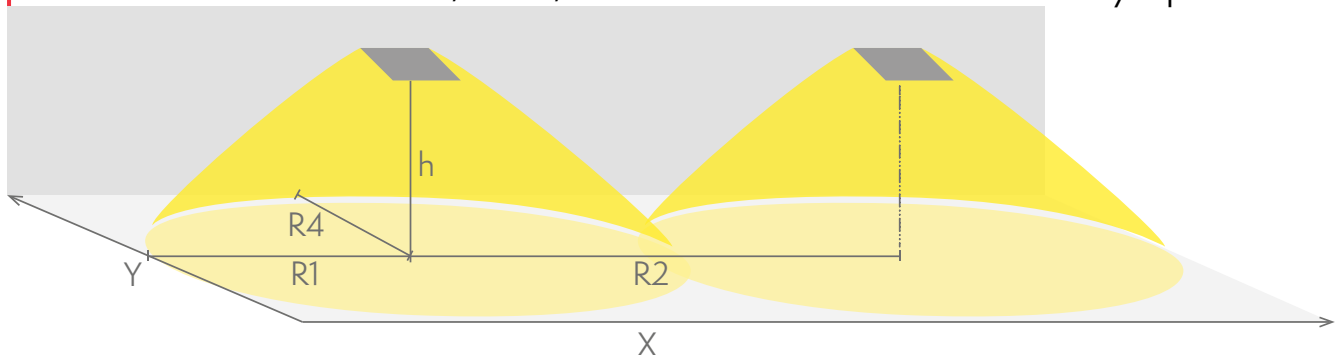

We reserve the rights to make modifications without notice.

Copyright © 2021 Teknoware. All rights reserved.

Date: February 15, 2021 | Source:

www.teknoware.com/en/emergency-lighting/solid-line-midbay-led-emergency-light-twt4341

wk



Teknoware Oy | P.O. Box 19, 15101 Lahti | Ilmarisentie 8, 15200 Lahti Finland

Tel +358 3 883 020 | VAT-number FI01494751 | teknoware.com | emexit@teknoware.com

R1 distance from wall (X axis)
 R2 installation distance between lights (X axis)
 R4 distance from wall (Y axis)
TWT4341WK

Mounting height (m)	Below the light lux	R1 (m)	R2 (m)	R4 (m)
		1 lux	1 lux	1 lux
2,5	45	5	10	1
3	31	5,5	11	1
4	17,5	6	15	1
6	7,5	9	18	1
8	4	9	19	1
10	2	10	20	1

OPTIONAL ACCESSORIES:

OPTIONAL MOUNTING ACCESSORIES FOR EMERGENCY EXIT LIGHTS



Product Code	Product Name	Compatible Product Groups
TWT3006	Solid Suspension Bracket TWT3006	Solid Exit 2 Emergency Exit Lights, Solid: Line Lowbay Emergency Lights, Solid: Line Midbay Emergency Lights, Solid: Zone Lowbay Emergency Lights, Solid: Zone Midbay Emergency Lights

COMPATIBLE PRODUCTS:

OPTIONAL MOUNTING ACCESSORIES FOR EMERGENCY EXIT LIGHTS



Product Code	Product Name	Compatible Product Groups
TWT3001	Solid Recess Mounting Frame TWT3001	Solid Exit Emergency Exit Lights, Solid Exit 2 Emergency Exit Lights, Solid: Line Lowbay Emergency Lights, Solid: Line Midbay Emergency Lights, Solid: Zone Lowbay Emergency Lights, Solid: Zone Midbay Emergency Lights
TWT3002	Solid Wall bracket TWT3002	Solid Exit Emergency Exit Lights, Solid Exit 2 Emergency Exit Lights, Solid: Line Lowbay Emergency Lights, Solid: Line Midbay Emergency Lights, Solid: Zone Lowbay Emergency Lights, Solid: Zone Midbay Emergency Lights
TWT3003	Solid Flag bracket TWT3003	Solid Exit Emergency Exit Lights, Solid Exit 2 Emergency Exit Lights, Solid: Line Lowbay Emergency Lights, Solid: Line Midbay Emergency Lights, Solid: Zone Lowbay Emergency Lights, Solid: Zone Midbay Emergency Lights

We reserve the rights to make modifications without notice.
 Copyright © 2021 Teknoware. All rights reserved.
 Date: February 15, 2021 | Source:
www.teknoware.com/en/emergency-lighting/solid-line-midbay-led-emergency-light-twt4341-wk



Product Code	Product Name	Compatible Product Groups
TWT3004	Solid Ceiling bracket TWT3004	Solid Exit Emergency Exit Lights, Solid Exit 2 Emergency Exit Lights, Solid: Line Lowbay Emergency Lights, Solid: Line Midbay Emergency Lights, Solid: Zone Lowbay Emergency Lights, Solid: Zone Midbay Emergency Lights

We reserve the rights to make modifications without notice.

Copyright © 2021 Teknoware. All rights reserved.

Date: February 15, 2021 | Source:

www.teknoware.com/en/emergency-lighting/solid-line-midbay-led-emergency-light-twt4341-wk



Teknoware Oy | P.O. Box 19, 15101 Lahti | Ilmarisentie 8, 15200 Lahti Finland

Tel +358 3 883 020 | VAT-number FI01494751 | teknoware.com | emexit@teknoware.com

SOLID LINE MIDBAY LED EMERGENCY LIGHT TWT4351WK

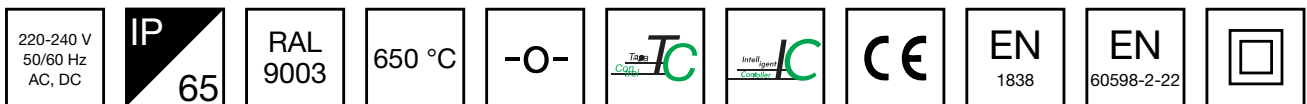

Addressable 230 V centrally supplied LED emergency light for escape routes

SOLID Line Midbay is designed for escape route emergency lighting. The luminaire is completely dust proof and water proof, so it is suitable for example for industrial premises and parking halls. ESCAP and centrally supplied luminaires are also suitable for outdoor use.

The SOLID luminaire uses long lasting leds as its light source.

Special attention has been paid to the design, for easy installation.

INDIVIDUALLY PACKED LIGHTS

The product codes starting with letter Y include an individually packed luminaire. The product codes starting with TW include the luminaire only.

Product Code	IP Class	Luminous Flux (lm)
Y4351WK	IP65	240

Product Code	TWT4351WK
Feature	Intelligent Controller, Tapsa Control
Mounting (standard)	surface
Customs Code	94056080
GTIN Code	6438045021072
ETIM Product Class	EC001957
Length	371 mm
Width	181 mm
Height	57 mm
Weight	1,1 kg
Max Input Power VA	10 VA
Max Input Power W	6 W
Nominal Supply Voltage	220-240 V, 50/60 Hz AC, DC
Protection Class	II
IP Class	IP65
Temperature Range Min - Max	-30...+50 °C
Glow Wire Test of Plastic Materials	650 °C
Body Material	plastic
Colour	RAL9003
Electrical Installation	2/3 x 2,5 mm ²

We reserve the rights to make modifications without notice.

Copyright © 2021 Teknoware. All rights reserved.

Date: February 15, 2021 | Source:

www.teknoware.com/en/emergency-lighting/solid-line-midbay-led-emergency-light-twt4351wk

Teknoware Oy | P.O. Box 19, 15101 Lahti | Ilmarisentie 8, 15200 Lahti Finland
Tel +358 3 883 020 | VAT-number FI01494751 | teknoware.com | emexit@teknoware.com



Emergency lighting for escape routes (ceiling mounting)

Table of 1 lux for escape routes in the middle line according to the norm EN 1838.

Level of measurement 0,02 m, measurement result with battery operation.

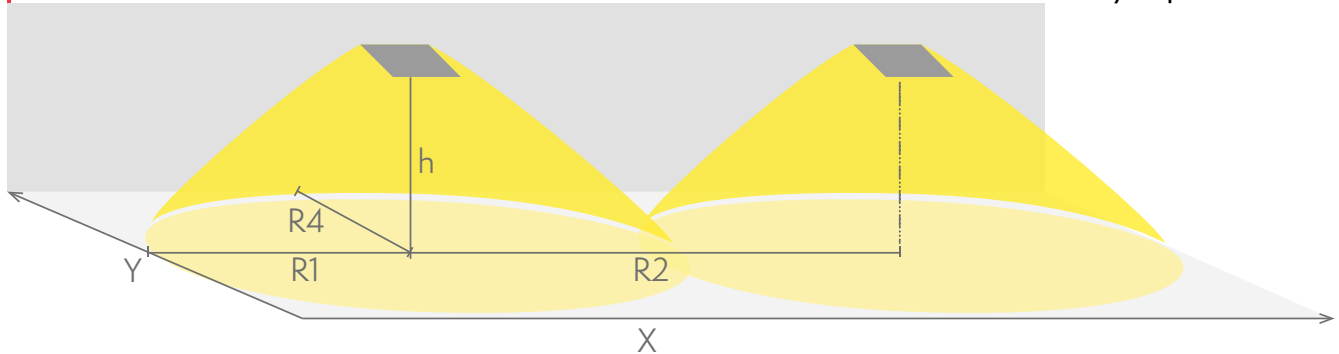

R1 distance from wall (X axis)

R2 installation distance between lights (X axis)

R4 distance from wall (Y axis)

TWT4351WK

Mounting height (m)	Below the light lux	R1 (m)	R2 (m)	R4 (m)
		1 lux	1 lux	1 lux
2,5	45	5	10	1
3	31	5,5	11	1
4	17,5	6	15	1
6	7,5	7	18	1
8	4	8	19	1
10	2	8	20	1

OPTIONAL ACCESSORIES:

OPTIONAL MOUNTING ACCESSORIES FOR EMERGENCY EXIT LIGHTS



Product Code	Product Name	Compatible Product Groups
TWT3006	Solid Suspension Bracket TWT3006	Solid Exit 2 Emergency Exit Lights, Solid: Line Lowbay Emergency Lights, Solid: Line Midbay Emergency Lights, Solid: Zone Lowbay Emergency Lights, Solid: Zone Midbay Emergency Lights

We reserve the rights to make modifications without notice.

Copyright © 2021 Teknoware. All rights reserved.

Date: February 15, 2021 | Source:

www.teknoware.com/en/emergency-lighting/solid-line-midbay-led-emergency-light-twt4351

wk



COMPATIBLE PRODUCTS:

OPTIONAL MOUNTING ACCESSORIES FOR EMERGENCY EXIT LIGHTS



Product Code	Product Name	Compatible Product Groups
TWT3001	Solid Recess Mounting Frame TWT3001	Solid Exit Emergency Exit Lights, Solid Exit 2 Emergency Exit Lights, Solid: Line Lowbay Emergency Lights, Solid: Line Midbay Emergency Lights, Solid: Zone Lowbay Emergency Lights, Solid: Zone Midbay Emergency Lights
TWT3002	Solid Wall bracket TWT3002	Solid Exit Emergency Exit Lights, Solid Exit 2 Emergency Exit Lights, Solid: Line Lowbay Emergency Lights, Solid: Line Midbay Emergency Lights, Solid: Zone Lowbay Emergency Lights, Solid: Zone Midbay Emergency Lights
TWT3003	Solid Flag bracket TWT3003	Solid Exit Emergency Exit Lights, Solid Exit 2 Emergency Exit Lights, Solid: Line Lowbay Emergency Lights, Solid: Line Midbay Emergency Lights, Solid: Zone Lowbay Emergency Lights, Solid: Zone Midbay Emergency Lights
TWT3004	Solid Ceiling bracket TWT3004	Solid Exit Emergency Exit Lights, Solid Exit 2 Emergency Exit Lights, Solid: Line Lowbay Emergency Lights, Solid: Line Midbay Emergency Lights, Solid: Zone Lowbay Emergency Lights, Solid: Zone Midbay Emergency Lights

We reserve the rights to make modifications without notice.

Copyright © 2021 Teknoware. All rights reserved.

Date: February 15, 2021 | Source:

www.teknoware.com/en/emergency-lighting/solid-line-midbay-led-emergency-light-twt4351

wk



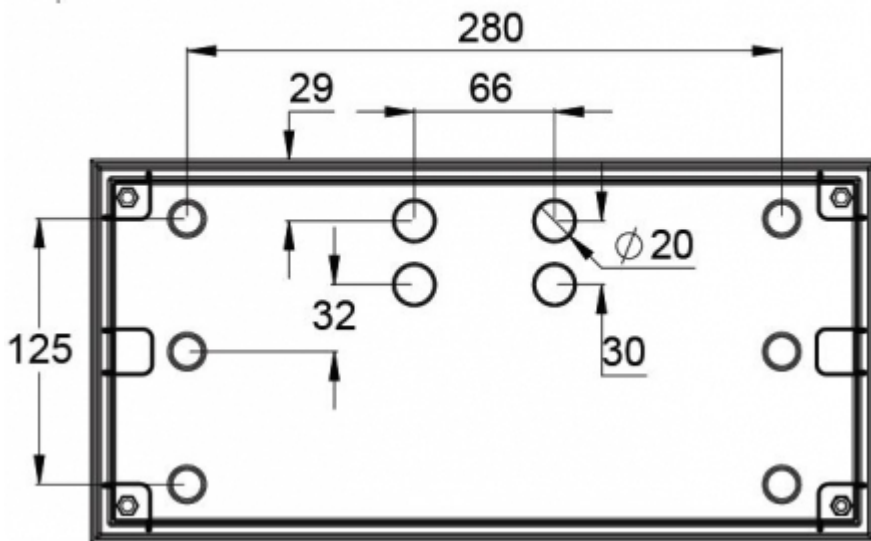
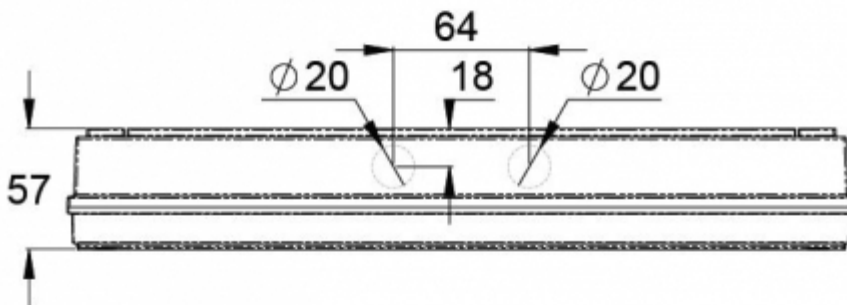
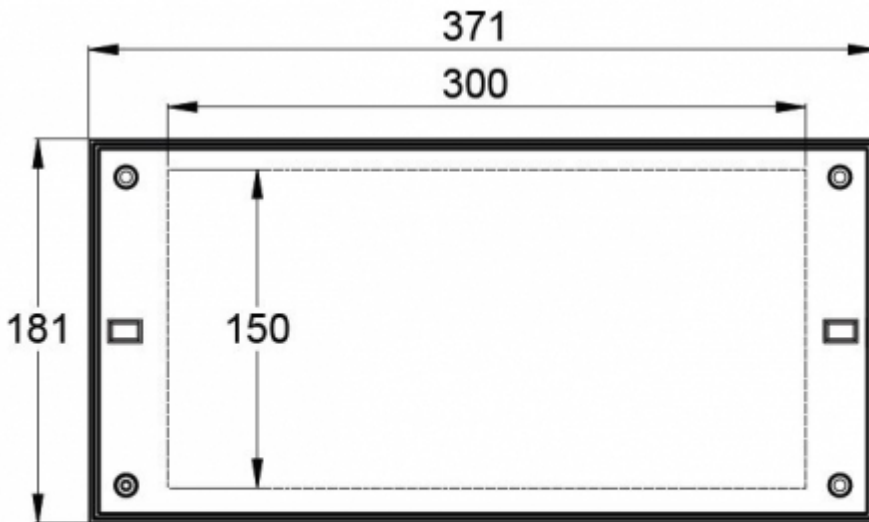

We reserve the rights to make modifications without notice.
 Copyright © 2021 Teknoware. All rights reserved.
 Date: February 15, 2021 | Source:
www.teknoware.com/en/emergency-lighting/solid-line-midbay-led-emergency-light-twt4351-wk



SOLID LINE MIDBAY LED EMERGENCY LIGHT TWT4351WKH



Addressable 230 V centrally supplied LED emergency light for escape routes

SOLID Line Midbay is designed for escape route emergency lighting. The luminaire is completely dust proof and water proof, so it is suitable for example for industrial premises and parking halls. Centrally supplied luminaires are also suitable for outdoor use.

The SOLID luminaire uses long lasting leds as its light source.

Special attention has been paid to the design, for easy installation. This model is a high output model that provides more power than TWT4351WK.

We reserve the rights to make modifications without notice.

Copyright © 2021 Teknoware. All rights reserved.

Date: February 15, 2021 | Source:

www.teknoware.com/en/emergency-lighting/solid-line-midbay-led-emergency-light-twt4351

wkh



Teknoware Oy | P.O. Box 19, 15101 Lahti | Ilmarisentie 8, 15200 Lahti Finland

Tel +358 3 883 020 | VAT-number FI01494751 | teknoware.com | emexit@teknoware.com

Product Code	TWT4351WKH
Feature	Intelligent Controller, Tapsa Control
Mounting (standard)	surface
Length	371 mm
Width	181 mm
Height	57 mm
Weight	1,1 kg
Max Input Power VA	14 VA
Max Input Power W	8,5 W
Nominal Supply Voltage	220-240 V, 50/60 Hz AC, DC
Protection Class	II
IP Class	IP65
Temperature Range Min - Max	-30...+50 °C
Glow Wire Test of Plastic Materials	650 °C
Body Material	plastic
Colour	RAL9003
Electrical Installation	2/3 x 2,5 mm ²
Luminous Flux	450 lm

Emergency lighting for escape routes (ceiling mounting)

Table of 1 lux for escape routes in the middle line according to the norm EN 1838.

Level of measurement 0,02 m, measurement result with battery operation.

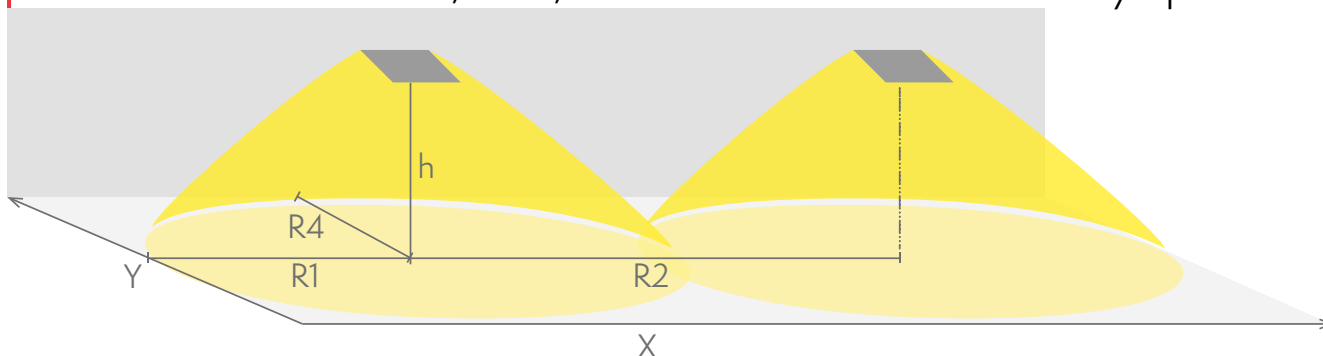

R1 distance from wall (X axis)

R2 installation distance between lights (X axis)

We reserve the rights to make modifications without notice.

Copyright © 2021 Teknoware. All rights reserved.

Date: February 15, 2021 | Source:

www.teknoware.com/en/emergency-lighting/solid-line-midbay-led-emergency-light-twt4351wkh



R4 distance from wall (Y axis) TWT4351WKH

Mounting height (m)	Below the light lux	R1 (m)	R2 (m)	R4 (m)
		1 lux	1 lux	1 lux
3	59	5	11	1
4	33	6,5	15	1
6	15	7	18	1
8	9	8	19	1
10	6	8	20	1
12	4	10	22	1
14	2,5	9,5	20	1
16	1,5	8,5	18	1

OPTIONAL ACCESSORIES:

OPTIONAL MOUNTING ACCESSORIES FOR EMERGENCY EXIT LIGHTS



Product Code	Product Name	Compatible Product Groups
TWT3006	Solid Suspension Bracket TWT3006	Solid Exit 2 Emergency Exit Lights, Solid: Line Lowbay Emergency Lights, Solid: Line Midbay Emergency Lights, Solid: Zone Lowbay Emergency Lights, Solid: Zone Midbay Emergency Lights

COMPATIBLE PRODUCTS:

OPTIONAL MOUNTING ACCESSORIES FOR EMERGENCY EXIT LIGHTS



Product Code	Product Name	Compatible Product Groups
TWT3001	Solid Recess Mounting Frame TWT3001	Solid Exit Emergency Exit Lights, Solid Exit 2 Emergency Exit Lights, Solid: Line Lowbay Emergency Lights, Solid: Line Midbay Emergency Lights, Solid: Zone Lowbay Emergency Lights, Solid: Zone Midbay Emergency Lights
TWT3002	Solid Wall bracket TWT3002	Solid Exit Emergency Exit Lights, Solid Exit 2 Emergency Exit Lights, Solid: Line Lowbay Emergency Lights, Solid: Line Midbay Emergency Lights, Solid: Zone Lowbay Emergency Lights, Solid: Zone Midbay Emergency Lights
TWT3003	Solid Flag bracket TWT3003	Solid Exit Emergency Exit Lights, Solid Exit 2 Emergency Exit Lights, Solid: Line Lowbay Emergency Lights, Solid: Line Midbay Emergency Lights, Solid: Zone Lowbay Emergency Lights, Solid: Zone Midbay Emergency Lights

We reserve the rights to make modifications without notice.

Copyright © 2021 Teknoware. All rights reserved.

Date: February 15, 2021 | Source:

www.teknoware.com/en/emergency-lighting/solid-line-midbay-led-emergency-light-twt4351-wkh

wkh



Product Code	Product Name	Compatible Product Groups
TWT3004	Solid Ceiling bracket TWT3004	Solid Exit Emergency Exit Lights, Solid Exit 2 Emergency Exit Lights, Solid: Line Lowbay Emergency Lights, Solid: Line Midbay Emergency Lights, Solid: Zone Lowbay Emergency Lights, Solid: Zone Midbay Emergency Lights

We reserve the rights to make modifications without notice.

Copyright © 2021 Teknoware. All rights reserved.

Date: February 15, 2021 | Source:

www.teknoware.com/en/emergency-lighting/solid-line-midbay-led-emergency-light-twt4351wkh



Teknoware Oy | P.O. Box 19, 15101 Lahti | Ilmarisentie 8, 15200 Lahti Finland
Tel +358 3 883 020 | VAT-number FI01494751 | teknoware.com | emexit@teknoware.com

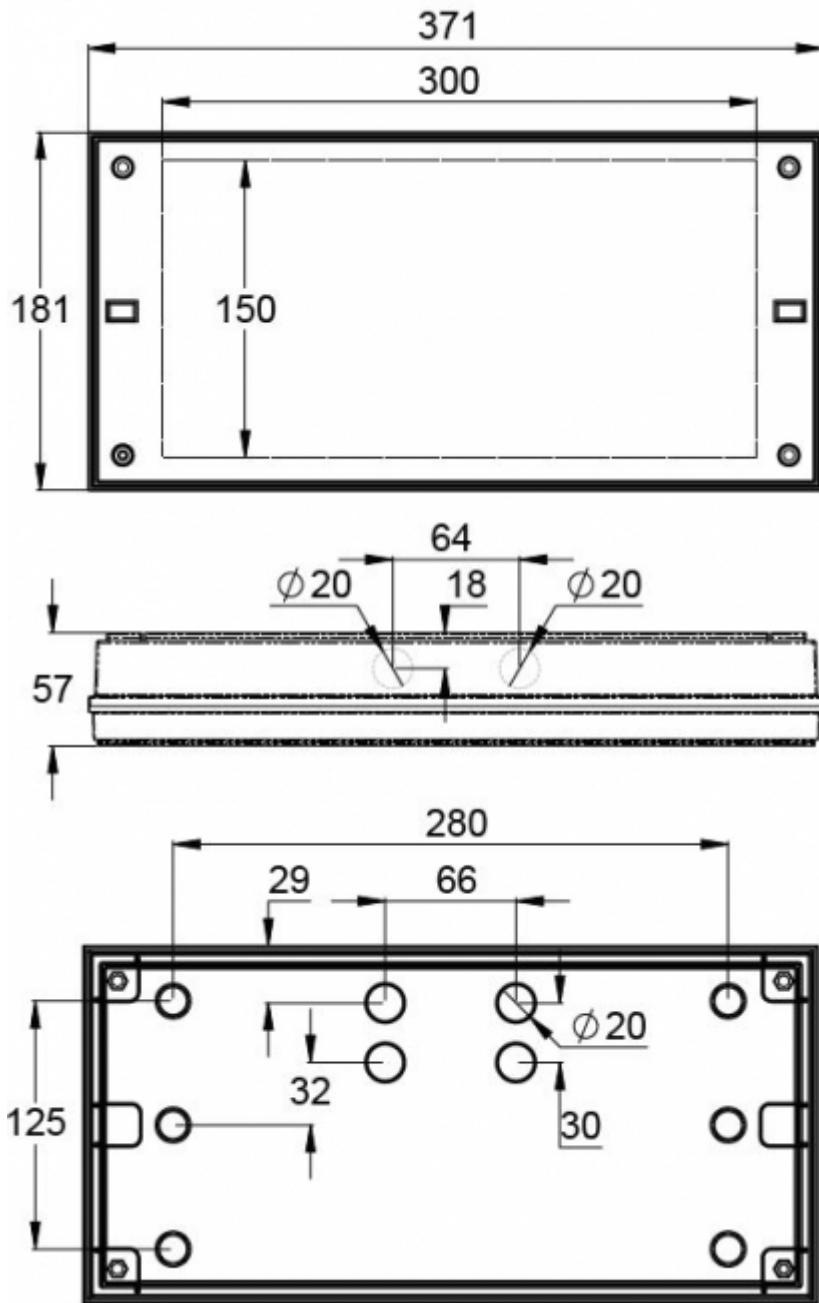

We reserve the rights to make modifications without notice.

Copyright © 2021 Teknoware. All rights reserved.

Date: February 15, 2021 | Source:

www.teknoware.com/en/emergency-lighting/solid-line-midbay-led-emergency-light-twt4351-wkh



Teknoware Oy | P.O. Box 19, 15101 Lahti | Ilmarisentie 8, 15200 Lahti Finland

Tel +358 3 883 020 | VAT-number FI01494751 | teknoware.com | emexit@teknoware.com

SOLID LINE MIDBAY LED EMERGENCY LIGHT TWT4352WA

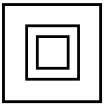
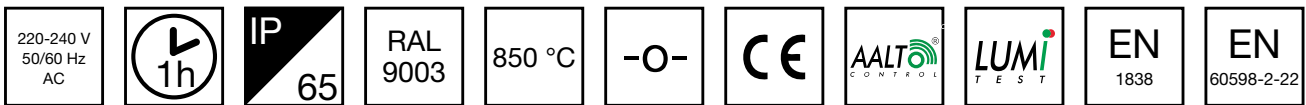

Self-contained 1 h Battery, Aalto Control compatible, LED emergency light

SOLID Line Midbay is designed for escape route emergency lighting. The luminaire is completely dust proof and water proof, so it is suitable for example for industrial premises and parking halls. ESCAP and centrally supplied luminaires are also suitable for outdoor use.

The SOLID luminaire uses long lasting leds as its light source.

Special attention has been paid to the design, for easy installation.

INDIVIDUALLY PACKED LIGHTS

The product codes starting with letter Y include an individually packed luminaire. The product codes starting with TW include the luminaire only.

Product Code	IP Class	Luminous Flux (lm)
Y4352WA	IP65	240

Product Code	TWT4352WA
Feature	Aalto Control, Lumi Test
Mounting (standard)	surface
Customs Code	94056080
GTIN Code	6438045021393
ETIM Product Class	EC001957
Length	371 mm
Width	181 mm
Height	57 mm
Weight	1,1 kg
Backup	1 h
Max Input Power VA	2,6 VA
Nominal Supply Voltage	220-240 V, 50/60 Hz AC
Protection Class	II
IP Class	IP65
Temperature Range Min - Max	-0...+35 °C
Glow Wire Test of Plastic Materials	850 °C
Body Material	plastic
Colour	RAL9003
Electrical Installation	2/3 x 2,5 mm ²

We reserve the rights to make modifications without notice.

Copyright © 2021 Teknoware. All rights reserved.

Date: February 15, 2021 | Source:

www.teknoware.com/en/emergency-lighting/solid-line-midbay-led-emergency-light-twt4352wa

Teknoware Oy | P.O. Box 19, 15101 Lahti | Ilmarisentie 8, 15200 Lahti Finland
Tel +358 3 883 020 | VAT-number FI01494751 | teknoware.com | emexit@teknoware.com



Emergency lighting for escape routes (ceiling mounting)

Table of 1 lux for escape routes in the middle line according to the norm EN 1838.

Level of measurement 0,02 m, measurement result with battery operation.

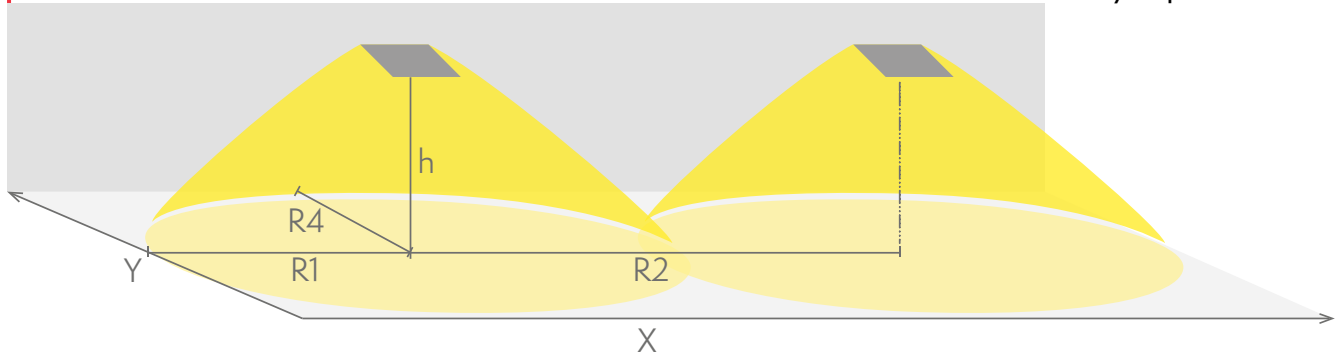

R1 distance from wall (X axis)

R2 installation distance between lights (X axis)

R4 distance from wall (Y axis)

TWT4352WA

Mounting height (m)	Below the light lux	R1 (m)	R2 (m)	R4 (m)
		1 lux	1 lux	1 lux
2,5	45	5	10	1
3	31	5,5	11	1
4	17,5	6	15	1
6	7,5	9	18	1
8	4	9	19	1
10	2	10	20	1

OPTIONAL ACCESSORIES:

OPTIONAL MOUNTING ACCESSORIES FOR EMERGENCY EXIT LIGHTS



Product Code	Product Name	Compatible Product Groups
TWT3006	Solid Suspension Bracket TWT3006	Solid Exit 2 Emergency Exit Lights, Solid: Line Lowbay Emergency Lights, Solid: Line Midbay Emergency Lights, Solid: Zone Lowbay Emergency Lights, Solid: Zone Midbay Emergency Lights

We reserve the rights to make modifications without notice.

Copyright © 2021 Teknoware. All rights reserved.

Date: February 15, 2021 | Source:

www.teknoware.com/en/emergency-lighting/solid-line-midbay-led-emergency-light-twt4352

wa



COMPATIBLE PRODUCTS:

OPTIONAL MOUNTING ACCESSORIES FOR EMERGENCY EXIT LIGHTS



Product Code	Product Name	Compatible Product Groups
TWT3001	Solid Recess Mounting Frame TWT3001	Solid Exit Emergency Exit Lights, Solid Exit 2 Emergency Exit Lights, Solid: Line Lowbay Emergency Lights, Solid: Line Midbay Emergency Lights, Solid: Zone Lowbay Emergency Lights, Solid: Zone Midbay Emergency Lights
TWT3002	Solid Wall bracket TWT3002	Solid Exit Emergency Exit Lights, Solid Exit 2 Emergency Exit Lights, Solid: Line Lowbay Emergency Lights, Solid: Line Midbay Emergency Lights, Solid: Zone Lowbay Emergency Lights, Solid: Zone Midbay Emergency Lights
TWT3003	Solid Flag bracket TWT3003	Solid Exit Emergency Exit Lights, Solid Exit 2 Emergency Exit Lights, Solid: Line Lowbay Emergency Lights, Solid: Line Midbay Emergency Lights, Solid: Zone Lowbay Emergency Lights, Solid: Zone Midbay Emergency Lights
TWT3004	Solid Ceiling bracket TWT3004	Solid Exit Emergency Exit Lights, Solid Exit 2 Emergency Exit Lights, Solid: Line Lowbay Emergency Lights, Solid: Line Midbay Emergency Lights, Solid: Zone Lowbay Emergency Lights, Solid: Zone Midbay Emergency Lights

We reserve the rights to make modifications without notice.

Copyright © 2021 Teknoware. All rights reserved.

Date: February 15, 2021 | Source:

www.teknoware.com/en/emergency-lighting/solid-line-midbay-led-emergency-light-twt4352

wa



Teknoware Oy | P.O. Box 19, 15101 Lahti | Ilmarisentie 8, 15200 Lahti Finland

Tel +358 3 883 020 | VAT-number FI01494751 | teknoware.com | emexit@teknoware.com



We reserve the rights to make modifications without notice.
Copyright © 2021 Teknoware. All rights reserved.
Date: February 15, 2021 | Source:
www.teknoware.com/en/emergency-lighting/solid-line-midbay-led-emergency-light-twt4352wa

Teknoware Oy | P.O. Box 19, 15101 Lahti | Ilmarisentie 8, 15200 Lahti Finland
Tel +358 3 883 020 | VAT-number FI01494751 | teknoware.com | emexit@teknoware.com



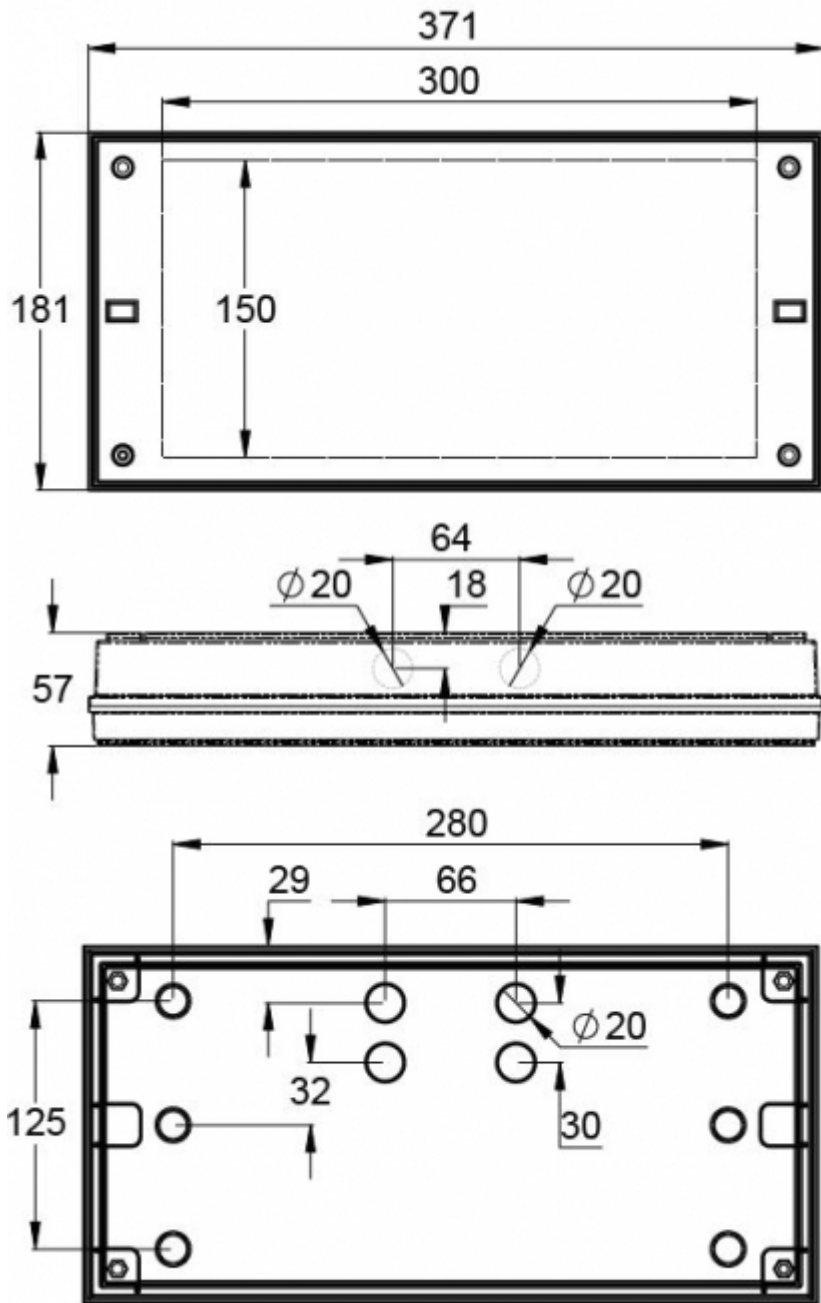

We reserve the rights to make modifications without notice.
 Copyright © 2021 Teknoware. All rights reserved.
 Date: February 15, 2021 | Source:
www.teknoware.com/en/emergency-lighting/solid-line-midbay-led-emergency-light-twt4352
 wa



Teknoware Oy | P.O. Box 19, 15101 Lahti | Ilmarisentie 8, 15200 Lahti Finland
 Tel +358 3 883 020 | VAT-number FI01494751 | teknoware.com | emexit@teknoware.com

SOLID LINE MIDBAY LED EMERGENCY LIGHT TWT4352WM

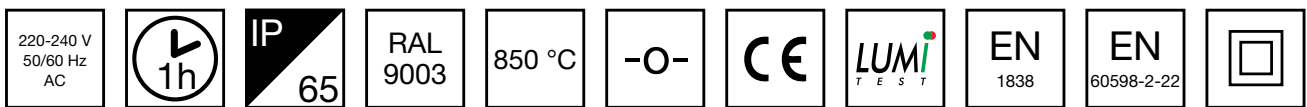

Self-contained 1 h Battery with Lumi Test Self-testing, LED emergency light

SOLID Line Midbay is designed for escape route emergency lighting. The luminaire is completely dust proof and water proof, so it is suitable for example for industrial premises and parking halls. ESCAP and centrally supplied luminaires are also suitable for outdoor use.

The SOLID luminaire uses long lasting leds as its light source.

Special attention has been paid to the design, for easy installation.

INDIVIDUALLY PACKED LIGHTS

The product codes starting with letter Y include an individually packed luminaire. The product codes starting with TW include the luminaire only.

Product Code	IP Class	Luminous Flux (lm)
Y4352WM	IP65	240

Product Code	TWT4352WM
Feature	Lumi Test
Mounting (standard)	surface
Customs Code	94056080
GTIN Code	6438045021478
ETIM Product Class	EC001957
Length	371 mm
Width	181 mm
Height	57 mm
Weight	1,1 kg
Backup	1 h
Max Input Power VA	2,1 VA
Nominal Supply Voltage	220-240 V, 50/60 Hz AC
Protection Class	II
IP Class	IP65
Temperature Range Min - Max	-0...+35 °C
Glow Wire Test of Plastic Materials	850 °C
Body Material	plastic
Colour	RAL9003
Electrical Installation	2/3 x 2,5 mm ²

We reserve the rights to make modifications without notice.

Copyright © 2021 Teknoware. All rights reserved.

Date: February 15, 2021 | Source:

www.teknoware.com/en/emergency-lighting/solid-line-midbay-led-emergency-light-twt4352

wm



Emergency lighting for escape routes (ceiling mounting)

Table of 1 lux for escape routes in the middle line according to the norm EN 1838.

Level of measurement 0,02 m, measurement result with battery operation.

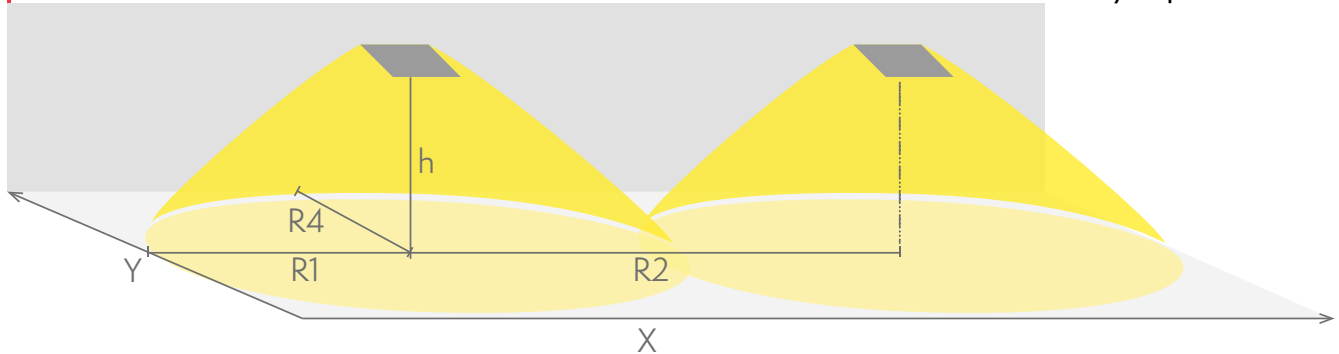

R1 distance from wall (X axis)

R2 installation distance between lights (X axis)

R4 distance from wall (Y axis)

TWT4352WM

Mounting height (m)	Below the light lux	R1 (m)	R2 (m)	R4 (m)
		1 lux	1 lux	1 lux
2,5	45	5	10	1
3	31	5,5	11	1
4	17,5	6	15	1
6	7,5	9	18	1
8	4	9	19	1
10	2	10	20	1

OPTIONAL ACCESSORIES:

OPTIONAL MOUNTING ACCESSORIES FOR EMERGENCY EXIT LIGHTS



Product Code	Product Name	Compatible Product Groups
TWT3006	Solid Suspension Bracket TWT3006	Solid Exit 2 Emergency Exit Lights, Solid: Line Lowbay Emergency Lights, Solid: Line Midbay Emergency Lights, Solid: Zone Lowbay Emergency Lights, Solid: Zone Midbay Emergency Lights

We reserve the rights to make modifications without notice.

Copyright © 2021 Teknoware. All rights reserved.

Date: February 15, 2021 | Source:

www.teknoware.com/en/emergency-lighting/solid-line-midbay-led-emergency-light-twt4352

wm



COMPATIBLE PRODUCTS:

OPTIONAL MOUNTING ACCESSORIES FOR EMERGENCY EXIT LIGHTS



Product Code	Product Name	Compatible Product Groups
TWT3001	Solid Recess Mounting Frame TWT3001	Solid Exit Emergency Exit Lights, Solid Exit 2 Emergency Exit Lights, Solid: Line Lowbay Emergency Lights, Solid: Line Midbay Emergency Lights, Solid: Zone Lowbay Emergency Lights, Solid: Zone Midbay Emergency Lights
TWT3002	Solid Wall bracket TWT3002	Solid Exit Emergency Exit Lights, Solid Exit 2 Emergency Exit Lights, Solid: Line Lowbay Emergency Lights, Solid: Line Midbay Emergency Lights, Solid: Zone Lowbay Emergency Lights, Solid: Zone Midbay Emergency Lights
TWT3003	Solid Flag bracket TWT3003	Solid Exit Emergency Exit Lights, Solid Exit 2 Emergency Exit Lights, Solid: Line Lowbay Emergency Lights, Solid: Line Midbay Emergency Lights, Solid: Zone Lowbay Emergency Lights, Solid: Zone Midbay Emergency Lights
TWT3004	Solid Ceiling bracket TWT3004	Solid Exit Emergency Exit Lights, Solid Exit 2 Emergency Exit Lights, Solid: Line Lowbay Emergency Lights, Solid: Line Midbay Emergency Lights, Solid: Zone Lowbay Emergency Lights, Solid: Zone Midbay Emergency Lights

We reserve the rights to make modifications without notice.

Copyright © 2021 Teknoware. All rights reserved.

Date: February 15, 2021 | Source:

www.teknoware.com/en/emergency-lighting/solid-line-midbay-led-emergency-light-twt4352

wm



Teknoware Oy | P.O. Box 19, 15101 Lahti | Ilmarisentie 8, 15200 Lahti Finland

Tel +358 3 883 020 | VAT-number FI01494751 | teknoware.com | emexit@teknoware.com



We reserve the rights to make modifications without notice.
Copyright © 2021 Teknoware. All rights reserved.
Date: February 15, 2021 | Source:
www.teknoware.com/en/emergency-lighting/solid-line-midbay-led-emergency-light-twt4352-wm

Teknoware Oy | P.O. Box 19, 15101 Lahti | Ilmarisentie 8, 15200 Lahti Finland
Tel +358 3 883 020 | VAT-number FI01494751 | teknoware.com | emexit@teknoware.com



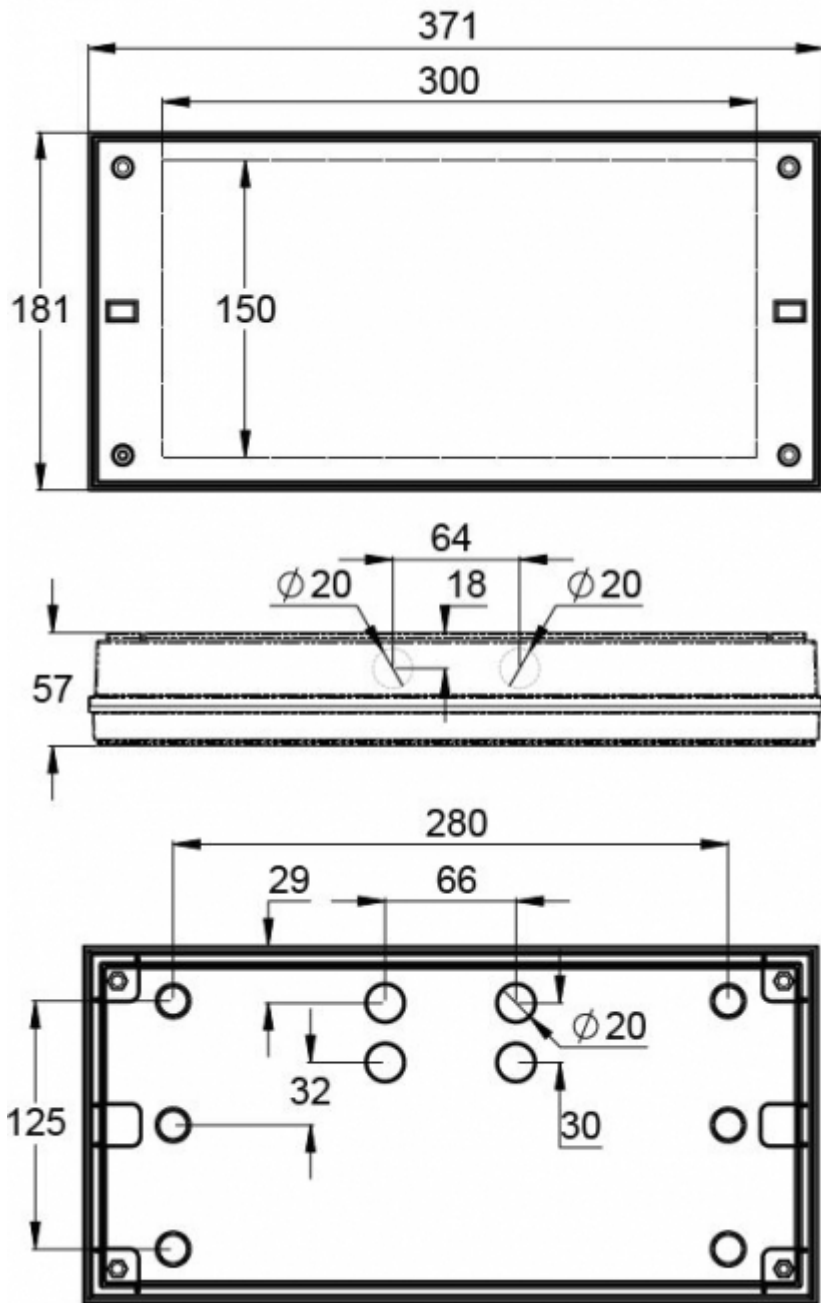

We reserve the rights to make modifications without notice.

Copyright © 2021 Teknoware. All rights reserved.

Date: February 15, 2021 | Source:

www.teknoware.com/en/emergency-lighting/solid-line-midbay-led-emergency-light-twt4352-wm



Teknoware Oy | P.O. Box 19, 15101 Lahti | Ilmarisentie 8, 15200 Lahti Finland

Tel +358 3 883 020 | VAT-number FI01494751 | teknoware.com | emexit@teknoware.com

SOLID LINE MIDBAY LED EMERGENCY LIGHT TWT4353WA

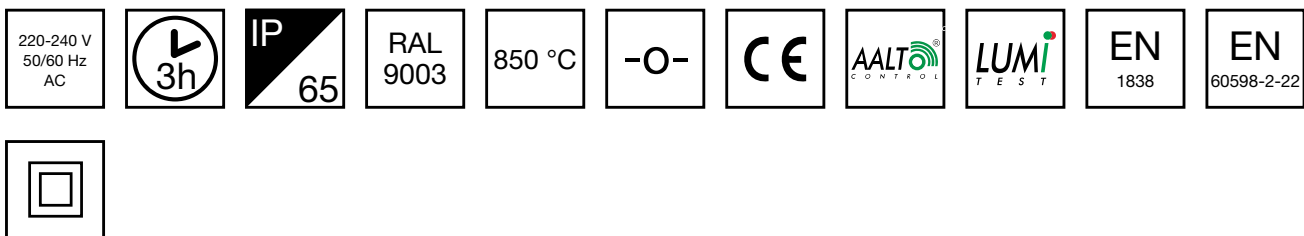

Self-contained 3 h Battery, Aalto Control compatible, LED emergency light

SOLID Line Midbay is designed for escape route emergency lighting. The luminaire is completely dust proof and water proof, so it is suitable for example for industrial premises and parking halls. ESCAP and centrally supplied luminaires are also suitable for outdoor use.

The SOLID luminaire uses long lasting leds as its light source.

Special attention has been paid to the design, for easy installation.

INDIVIDUALLY PACKED LIGHTS

The product codes starting with letter Y include an individually packed luminaire. The product codes starting with TW include the luminaire only.

Product Code	IP Class	Luminous Flux (lm)
Y4353WA	IP65	240

Product Code	TWT4353WA
Feature	Aalto Control, Lumi Test
Mounting (standard)	surface
Customs Code	94056080
GTIN Code	6438045021430
ETIM Product Class	EC001957
Length	371 mm
Width	181 mm
Height	57 mm
Weight	1,1 kg
Backup	3 h
Max Input Power VA	3,5 VA
Nominal Supply Voltage	220-240 V, 50/60 Hz AC
Protection Class	II
IP Class	IP65
Temperature Range Min - Max	-0...+35 °C
Glow Wire Test of Plastic Materials	850 °C
Body Material	plastic
Colour	RAL9003
Electrical Installation	2/3 x 2,5 mm ²

We reserve the rights to make modifications without notice.

Copyright © 2021 Teknoware. All rights reserved.

Date: February 15, 2021 | Source:

www.teknoware.com/en/emergency-lighting/solid-line-midbay-led-emergency-light-twt4353

wa



Emergency lighting for escape routes (ceiling mounting)

Table of 1 lux for escape routes in the middle line according to the norm EN 1838.

Level of measurement 0,02 m, measurement result with battery operation.

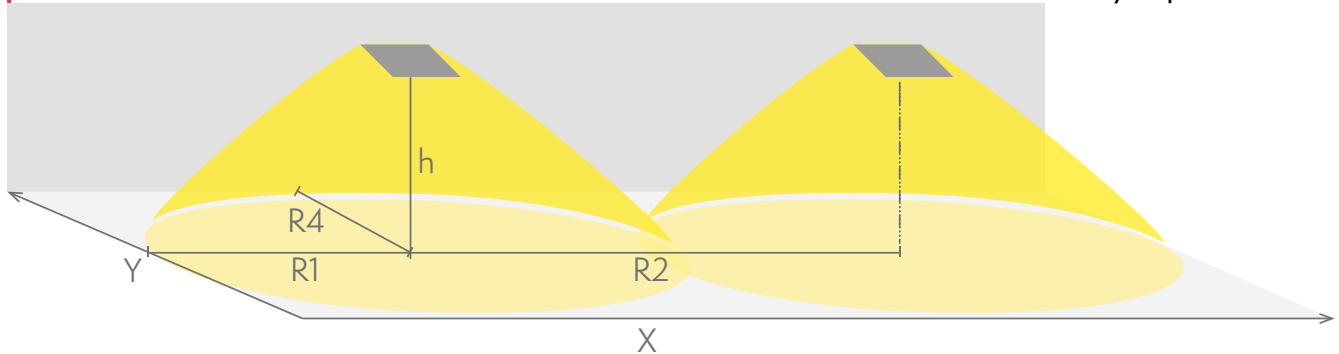

R1 distance from wall (X axis)

R2 installation distance between lights (X axis)

R4 distance from wall (Y axis)

TWT4353WA

Mounting height (m)	Below the light lux	R1 (m)	R2 (m)	R4 (m)
		1 lux	1 lux	1 lux
2,5	45	5	10	1
3	31	5,5	11	1
4	17,5	6	15	1
6	7,5	9	18	1
8	4	9	19	1
10	2	10	20	1

OPTIONAL ACCESSORIES:

OPTIONAL MOUNTING ACCESSORIES FOR EMERGENCY EXIT LIGHTS



Product Code	Product Name	Compatible Product Groups
TWT3006	Solid Suspension Bracket TWT3006	Solid Exit 2 Emergency Exit Lights, Solid: Line Lowbay Emergency Lights, Solid: Line Midbay Emergency Lights, Solid: Zone Lowbay Emergency Lights, Solid: Zone Midbay Emergency Lights

We reserve the rights to make modifications without notice.

Copyright © 2021 Teknoware. All rights reserved.

Date: February 15, 2021 | Source:

www.teknoware.com/en/emergency-lighting/solid-line-midbay-led-emergency-light-twt4353

wa



COMPATIBLE PRODUCTS:

OPTIONAL MOUNTING ACCESSORIES FOR EMERGENCY EXIT LIGHTS



Product Code	Product Name	Compatible Product Groups
TWT3001	Solid Recess Mounting Frame TWT3001	Solid Exit Emergency Exit Lights, Solid Exit 2 Emergency Exit Lights, Solid: Line Lowbay Emergency Lights, Solid: Line Midbay Emergency Lights, Solid: Zone Lowbay Emergency Lights, Solid: Zone Midbay Emergency Lights
TWT3002	Solid Wall bracket TWT3002	Solid Exit Emergency Exit Lights, Solid Exit 2 Emergency Exit Lights, Solid: Line Lowbay Emergency Lights, Solid: Line Midbay Emergency Lights, Solid: Zone Lowbay Emergency Lights, Solid: Zone Midbay Emergency Lights
TWT3003	Solid Flag bracket TWT3003	Solid Exit Emergency Exit Lights, Solid Exit 2 Emergency Exit Lights, Solid: Line Lowbay Emergency Lights, Solid: Line Midbay Emergency Lights, Solid: Zone Lowbay Emergency Lights, Solid: Zone Midbay Emergency Lights
TWT3004	Solid Ceiling bracket TWT3004	Solid Exit Emergency Exit Lights, Solid Exit 2 Emergency Exit Lights, Solid: Line Lowbay Emergency Lights, Solid: Line Midbay Emergency Lights, Solid: Zone Lowbay Emergency Lights, Solid: Zone Midbay Emergency Lights

We reserve the rights to make modifications without notice.

Copyright © 2021 Teknoware. All rights reserved.

Date: February 15, 2021 | Source:

www.teknoware.com/en/emergency-lighting/solid-line-midbay-led-emergency-light-twt4353

wa



Teknoware Oy | P.O. Box 19, 15101 Lahti | Ilmarisentie 8, 15200 Lahti Finland

Tel +358 3 883 020 | VAT-number FI01494751 | teknoware.com | emexit@teknoware.com



We reserve the rights to make modifications without notice.
Copyright © 2021 Teknoware. All rights reserved.
Date: February 15, 2021 | Source:
www.teknoware.com/en/emergency-lighting/solid-line-midbay-led-emergency-light-twt4353wa

Teknoware Oy | P.O. Box 19, 15101 Lahti | Ilmarisentie 8, 15200 Lahti Finland
Tel +358 3 883 020 | VAT-number FI01494751 | teknoware.com | emexit@teknoware.com



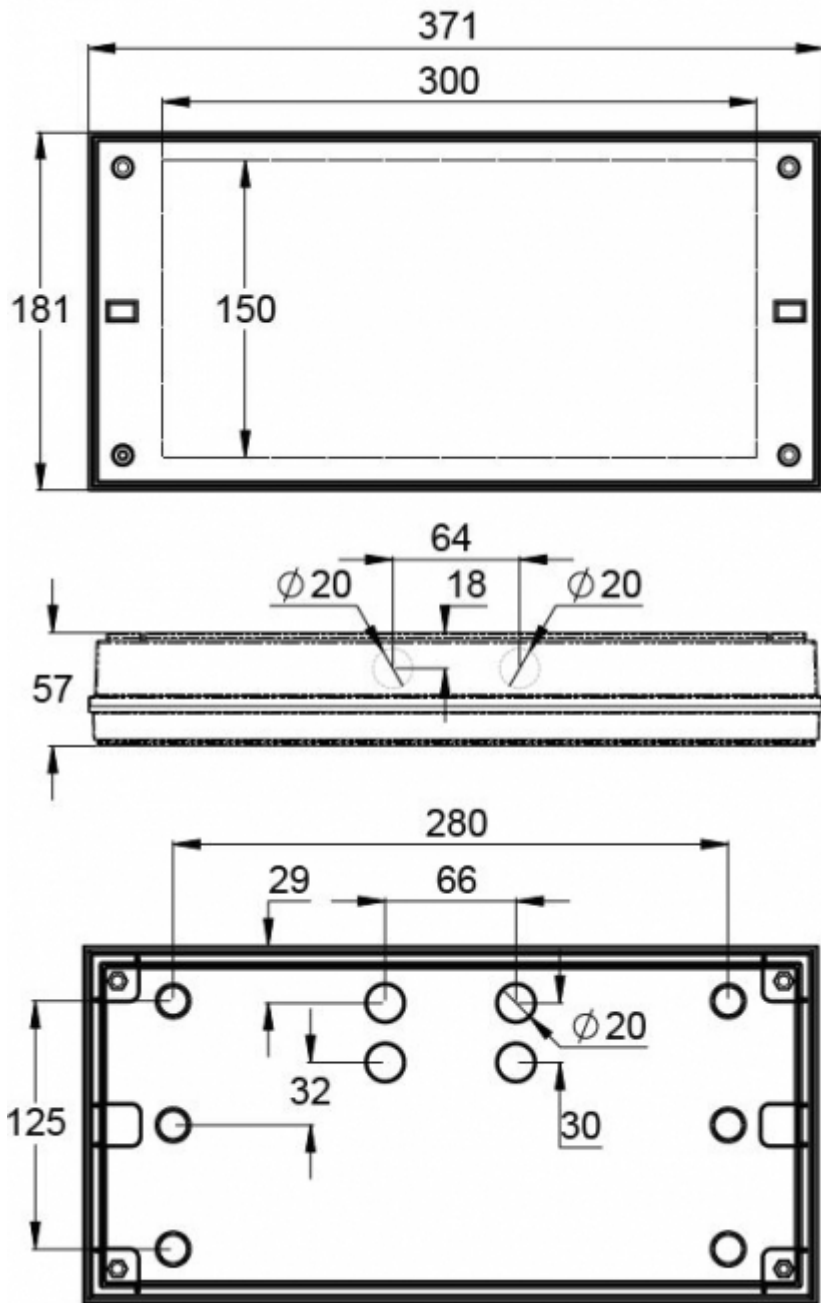

We reserve the rights to make modifications without notice.
 Copyright © 2021 Teknoware. All rights reserved.
 Date: February 15, 2021 | Source:
www.teknoware.com/en/emergency-lighting/solid-line-midbay-led-emergency-light-twt4353wa



Teknoware Oy | P.O. Box 19, 15101 Lahti | Ilmarisentie 8, 15200 Lahti Finland
 Tel +358 3 883 020 | VAT-number FI01494751 | teknoware.com | emexit@teknoware.com

SOLID LINE MIDBAY LED EMERGENCY LIGHT TWT4353WM

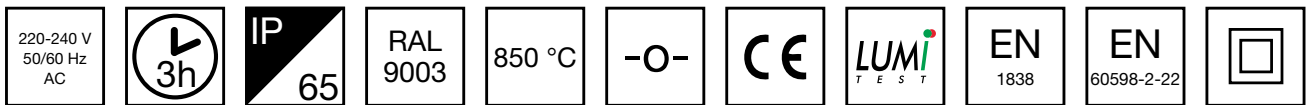

Self-contained 3 h Battery with Lumi Test Self-testing, LED emergency light

SOLID Line Midbay is designed for escape route emergency lighting. The luminaire is completely dust proof and water proof, so it is suitable for example for industrial premises and parking halls. ESCAP and centrally supplied luminaires are also suitable for outdoor use.

The SOLID luminaire uses long lasting leds as its light source.

Special attention has been paid to the design, for easy installation.

INDIVIDUALLY PACKED LIGHTS

The product codes starting with letter Y include an individually packed luminaire. The product codes starting with TW include the luminaire only.

Product Code	IP Class	Luminous Flux (lm)
Y4353WM	IP65	240

Product Code	TWT4353WM
Feature	Lumi Test
Mounting (standard)	surface
Customs Code	94056080
GTIN Code	6438045021515
ETIM Product Class	EC001957
Length	371 mm
Width	181 mm
Height	57 mm
Weight	1,1 kg
Backup	3 h
Max Input Power VA	3,3 VA
Nominal Supply Voltage	220-240 V, 50/60 Hz AC
Protection Class	II
IP Class	IP65
Temperature Range Min - Max	-0...+35 °C
Glow Wire Test of Plastic Materials	850 °C
Body Material	plastic
Colour	RAL9003
Electrical Installation	2/3 x 2,5 mm ²

We reserve the rights to make modifications without notice.

Copyright © 2021 Teknoware. All rights reserved.

Date: February 15, 2021 | Source:

www.teknoware.com/en/emergency-lighting/solid-line-midbay-led-emergency-light-twt4353

wm



Emergency lighting for escape routes (ceiling mounting)

Table of 1 lux for escape routes in the middle line according to the norm EN 1838.

Level of measurement 0,02 m, measurement result with battery operation.

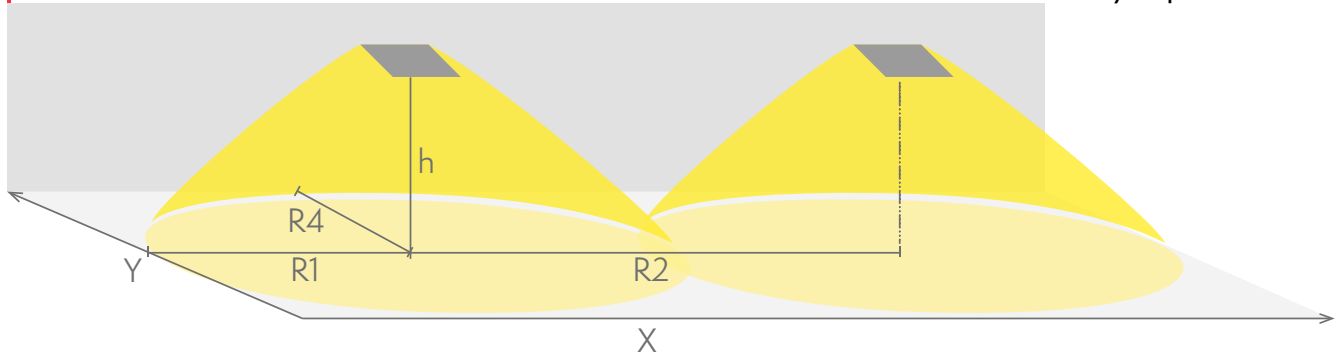

R1 distance from wall (X axis)

R2 installation distance between lights (X axis)

R4 distance from wall (Y axis)

TWT4353WM

Mounting height (m)	Below the light lux	R1 (m)	R2 (m)	R4 (m)
		1 lux	1 lux	1 lux
2,5	45	5	10	1
3	31	5,5	11	1
4	17,5	6	15	1
6	7,5	9	18	1
8	4	9	19	1
10	2	10	20	1

OPTIONAL ACCESSORIES:

OPTIONAL MOUNTING ACCESSORIES FOR EMERGENCY EXIT LIGHTS



Product Code	Product Name	Compatible Product Groups
TWT3006	Solid Suspension Bracket TWT3006	Solid Exit 2 Emergency Exit Lights, Solid: Line Lowbay Emergency Lights, Solid: Line Midbay Emergency Lights, Solid: Zone Lowbay Emergency Lights, Solid: Zone Midbay Emergency Lights

We reserve the rights to make modifications without notice.

Copyright © 2021 Teknoware. All rights reserved.

Date: February 15, 2021 | Source:

www.teknoware.com/en/emergency-lighting/solid-line-midbay-led-emergency-light-twt4353wm

wm



COMPATIBLE PRODUCTS:

OPTIONAL MOUNTING ACCESSORIES FOR EMERGENCY EXIT LIGHTS



Product Code	Product Name	Compatible Product Groups
TWT3001	Solid Recess Mounting Frame TWT3001	Solid Exit Emergency Exit Lights, Solid Exit 2 Emergency Exit Lights, Solid: Line Lowbay Emergency Lights, Solid: Line Midbay Emergency Lights, Solid: Zone Lowbay Emergency Lights, Solid: Zone Midbay Emergency Lights
TWT3002	Solid Wall bracket TWT3002	Solid Exit Emergency Exit Lights, Solid Exit 2 Emergency Exit Lights, Solid: Line Lowbay Emergency Lights, Solid: Line Midbay Emergency Lights, Solid: Zone Lowbay Emergency Lights, Solid: Zone Midbay Emergency Lights
TWT3003	Solid Flag bracket TWT3003	Solid Exit Emergency Exit Lights, Solid Exit 2 Emergency Exit Lights, Solid: Line Lowbay Emergency Lights, Solid: Line Midbay Emergency Lights, Solid: Zone Lowbay Emergency Lights, Solid: Zone Midbay Emergency Lights
TWT3004	Solid Ceiling bracket TWT3004	Solid Exit Emergency Exit Lights, Solid Exit 2 Emergency Exit Lights, Solid: Line Lowbay Emergency Lights, Solid: Line Midbay Emergency Lights, Solid: Zone Lowbay Emergency Lights, Solid: Zone Midbay Emergency Lights

We reserve the rights to make modifications without notice.

Copyright © 2021 Teknoware. All rights reserved.

Date: February 15, 2021 | Source:

www.teknoware.com/en/emergency-lighting/solid-line-midbay-led-emergency-light-twt4353

wm





We reserve the rights to make modifications without notice.
Copyright © 2021 Teknoware. All rights reserved.
Date: February 15, 2021 | Source:
www.teknoware.com/en/emergency-lighting/solid-line-midbay-led-emergency-light-twt4353wm

Teknoware Oy | P.O. Box 19, 15101 Lahti | Ilmarisentie 8, 15200 Lahti Finland
Tel +358 3 883 020 | VAT-number FI01494751 | teknoware.com | emexit@teknoware.com



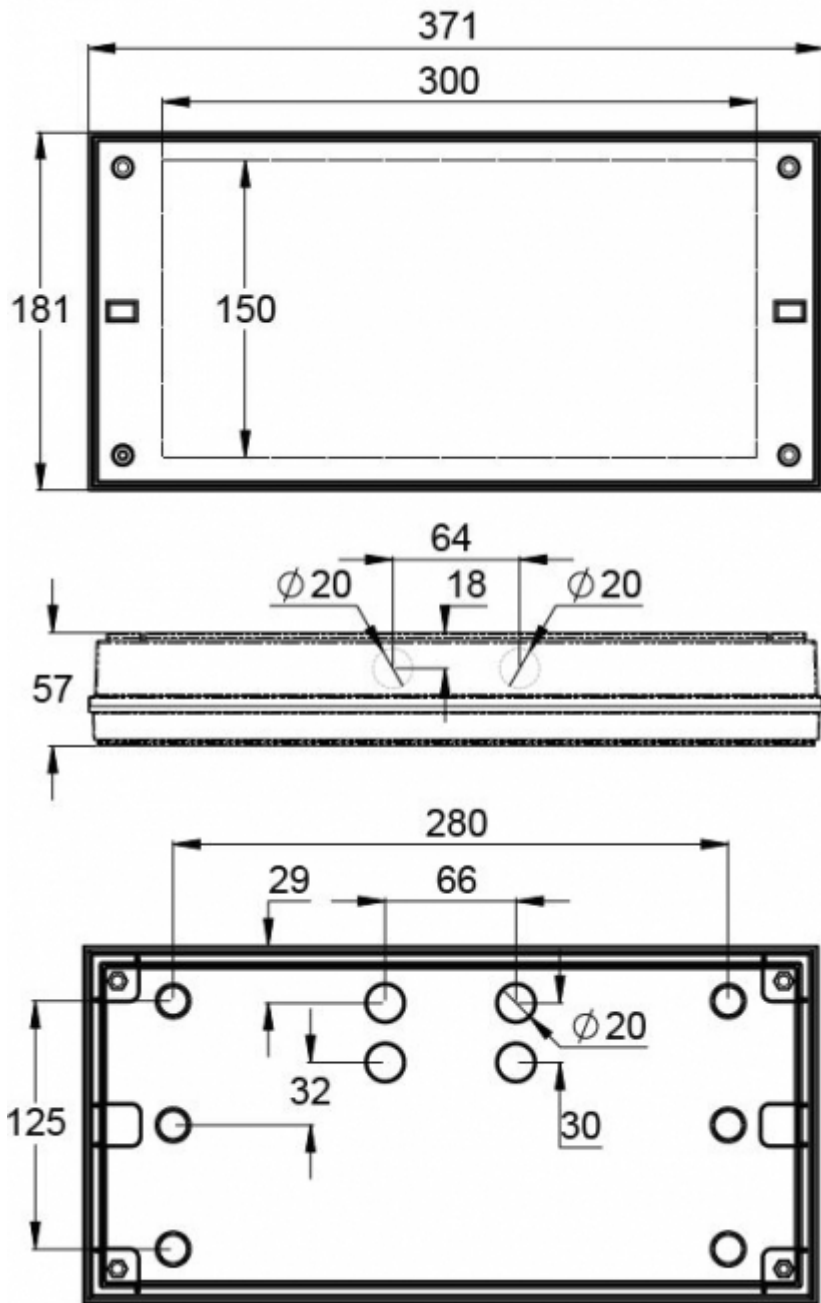

We reserve the rights to make modifications without notice.
 Copyright © 2021 Teknoware. All rights reserved.
 Date: February 15, 2021 | Source:
www.teknoware.com/en/emergency-lighting/solid-line-midbay-led-emergency-light-twt4353-wm



Teknoware Oy | P.O. Box 19, 15101 Lahti | Ilmarisentie 8, 15200 Lahti Finland
 Tel +358 3 883 020 | VAT-number FI01494751 | teknoware.com | emexit@teknoware.com

SOLID LINE MIDBAY LED EMERGENCY LIGHT TWT4371W

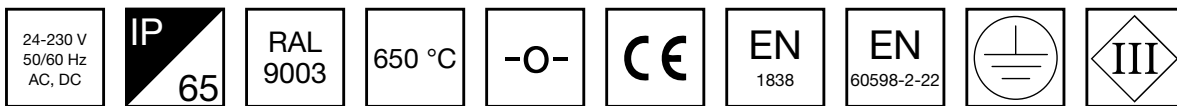

24-230 V centrally supplied LED emergency light for escape routes

SOLID Line Midbay is designed for escape route emergency lighting. The luminaire is completely dust proof and water proof, so it is suitable for example for industrial premises and parking halls. ESCAP and centrally supplied luminaires are also suitable for outdoor use.

The SOLID luminaire uses long lasting leds as its light source.

Special attention has been paid to the design, for easy installation.

INDIVIDUALLY PACKED LIGHTS

The product codes starting with letter Y include an individually packed luminaire. The product codes starting with TW include the luminaire only.

Product Code	IP Class	Luminous Flux (lm)
Y4371W	IP65	240

Product Code	TWT4371W
Mounting (standard)	surface
Customs Code	94056080
GTIN Code	6438045021355
ETIM Product Class	EC001957
Length	371 mm
Width	181 mm
Height	57 mm
Weight	1,1 kg
Max Input Power VA	7,5 VA (24 V), 10 VA (230 V)
Max Input Power W	4,5 W (24 V), 5 W (230 V)
Nominal Supply Voltage	24-230 V, 50/60 Hz AC, DC
Protection Class	III(24V),II(230V)
IP Class	IP65
Temperature Range Min - Max	-30...+50 °C
Glow Wire Test of Plastic Materials	650 °C
Body Material	plastic
Colour	RAL9003
Electrical Installation	2 x 2,5 mm ² (24 V), 3 x 2,5 mm ² (230 V)
Luminous Flux	240 lm

We reserve the rights to make modifications without notice.

Copyright © 2021 Teknoware. All rights reserved.

Date: February 15, 2021 | Source:

www.teknoware.com/en/emergency-lighting/solid-line-midbay-led-emergency-light-twt4371w

w



Emergency lighting for escape routes (ceiling mounting)

Table of 1 lux for escape routes in the middle line according to the norm EN 1838.

Level of measurement 0,02 m, measurement result with battery operation.

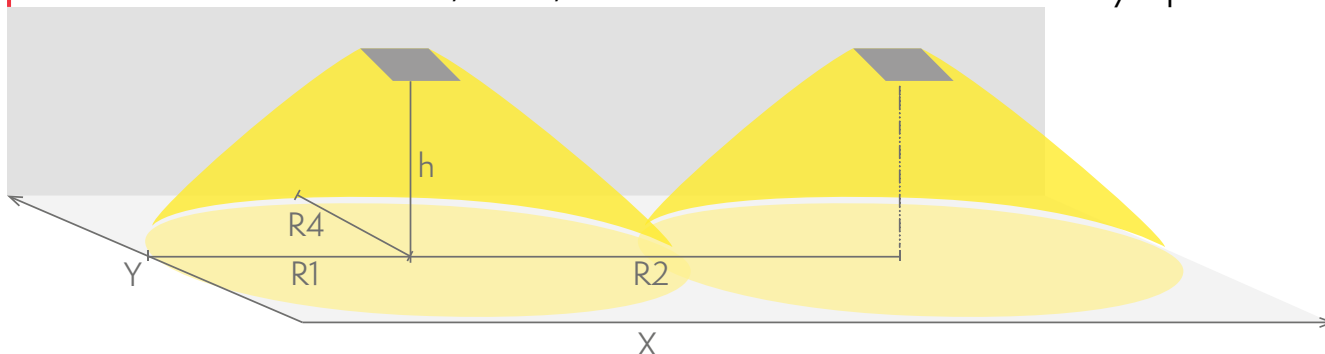

R1 distance from wall (X axis)

R2 installation distance between lights (X axis)

R4 distance from wall (Y axis)

TWT4371W

Mounting height (m)	Below the light lux	R1 (m)	R2 (m)	R4 (m)
		1 lux	1 lux	1 lux
2,5	45	5	10	1
3	31	5,5	11	1
4	17,5	6	15	1
6	7,5	9	18	1
8	4	9	19	1
10	2	10	20	1

OPTIONAL ACCESSORIES:

OPTIONAL MOUNTING ACCESSORIES FOR EMERGENCY EXIT LIGHTS



Product Code	Product Name	Compatible Product Groups
TWT3006	Solid Suspension Bracket TWT3006	Solid Exit 2 Emergency Exit Lights, Solid: Line Lowbay Emergency Lights, Solid: Line Midbay Emergency Lights, Solid: Zone Lowbay Emergency Lights, Solid: Zone Midbay Emergency Lights

We reserve the rights to make modifications without notice.

Copyright © 2021 Teknoware. All rights reserved.

Date: February 15, 2021 | Source:

www.teknoware.com/en/emergency-lighting/solid-line-midbay-led-emergency-light-twt4371w

w



Teknoware Oy | P.O. Box 19, 15101 Lahti | Ilmarisentie 8, 15200 Lahti Finland

Tel +358 3 883 020 | VAT-number FI01494751 | teknoware.com | emexit@teknoware.com

COMPATIBLE PRODUCTS:

OPTIONAL MOUNTING ACCESSORIES FOR EMERGENCY EXIT LIGHTS



Product Code	Product Name	Compatible Product Groups
TWT3001	Solid Recess Mounting Frame TWT3001	Solid Exit Emergency Exit Lights, Solid Exit 2 Emergency Exit Lights, Solid: Line Lowbay Emergency Lights, Solid: Line Midbay Emergency Lights, Solid: Zone Lowbay Emergency Lights, Solid: Zone Midbay Emergency Lights
TWT3002	Solid Wall bracket TWT3002	Solid Exit Emergency Exit Lights, Solid Exit 2 Emergency Exit Lights, Solid: Line Lowbay Emergency Lights, Solid: Line Midbay Emergency Lights, Solid: Zone Lowbay Emergency Lights, Solid: Zone Midbay Emergency Lights
TWT3003	Solid Flag bracket TWT3003	Solid Exit Emergency Exit Lights, Solid Exit 2 Emergency Exit Lights, Solid: Line Lowbay Emergency Lights, Solid: Line Midbay Emergency Lights, Solid: Zone Lowbay Emergency Lights, Solid: Zone Midbay Emergency Lights
TWT3004	Solid Ceiling bracket TWT3004	Solid Exit Emergency Exit Lights, Solid Exit 2 Emergency Exit Lights, Solid: Line Lowbay Emergency Lights, Solid: Line Midbay Emergency Lights, Solid: Zone Lowbay Emergency Lights, Solid: Zone Midbay Emergency Lights

We reserve the rights to make modifications without notice.

Copyright © 2021 Teknoware. All rights reserved.

Date: February 15, 2021 | Source:

www.teknoware.com/en/emergency-lighting/solid-line-midbay-led-emergency-light-twt4371

w



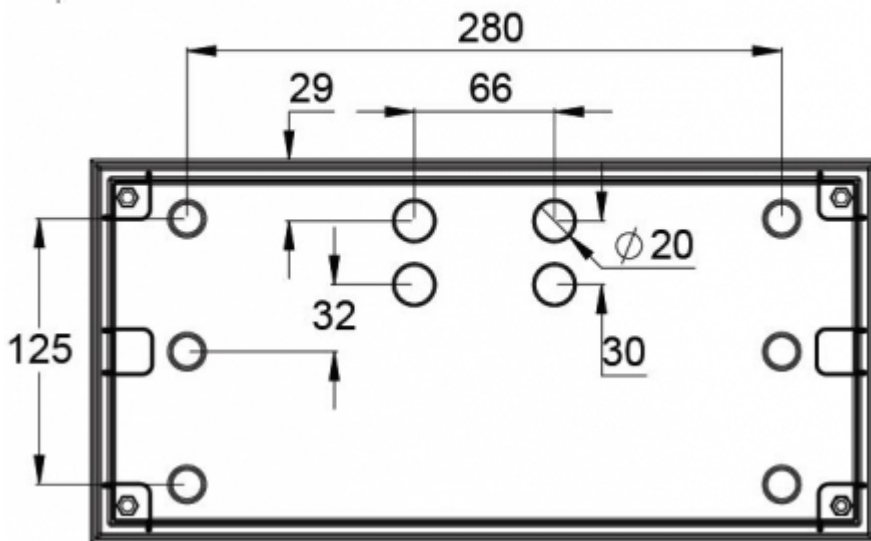
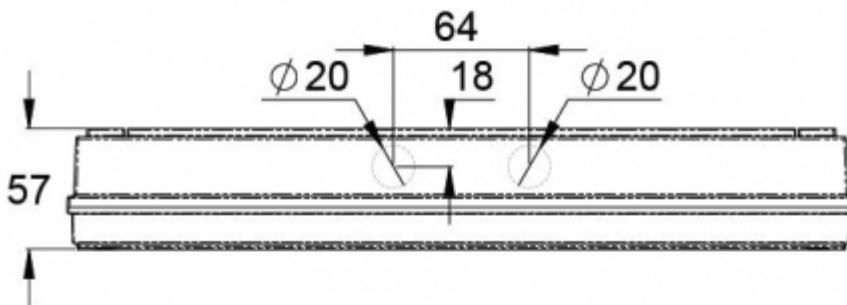
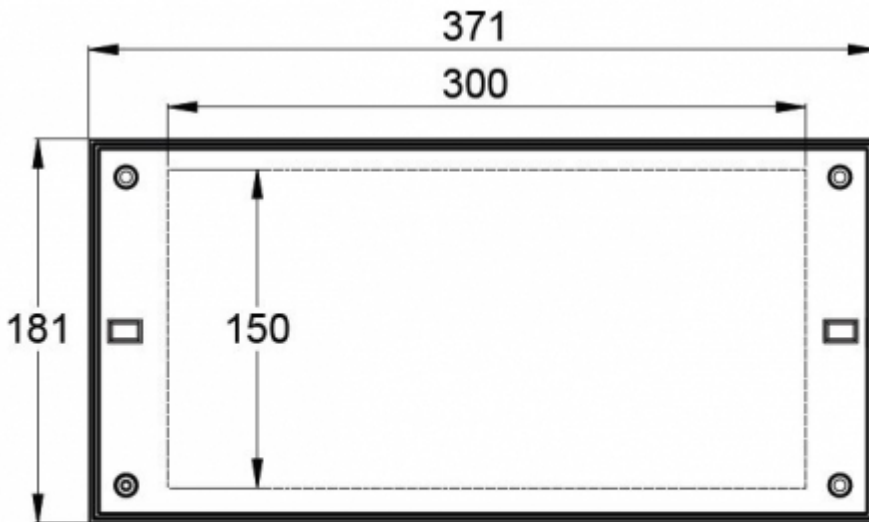

We reserve the rights to make modifications without notice.
 Copyright © 2021 Teknoware. All rights reserved.
 Date: February 15, 2021 | Source:
www.teknoware.com/en/emergency-lighting/solid-line-midbay-led-emergency-light-twt4371w

