

CARAN D'ACHE

Genève



CORPORATE

GIFTS

2017

LA MAISON
CARAN D'ACHE

FROM AN ARTIST'S SIGNATURE TO THE ART OF BEAUTIFUL WRITING

In that area of emotions where writing and images fuse together, the grace of a curving line, the energy in the stroke of a pen and the depth of a rich colour are among the elements that led Caran d'Ache to develop its passion for fine writing. Since 1915, steeped in the great traditions of Swiss Manufacturing, the company has created writing instruments, and a palette of colours, that are universally recognised symbols of excellence.

These reliable, precise and precious objects have acquired an international reputation for combining creativity and distinction with the use of noble materials.

To continue this policy, our Geneva workshops carefully preserve their independent spirit and their commitment to authenticity and ethical production.

MANUFACTURED IN GENEVA WORKSHOPS

Caran d'Ache draws on a priceless heritage of technical expertise to preserve the art of handwriting. The company's writing instruments, globally recognised for their excellence, are entirely produced in Geneva. In the secret of their workshops, Caran d'Ache craftsmen boldly combine expertise and aesthetics in the great Swiss Made tradition. To create these emotive objects, which are also feats of technology, they offer original materials and perfect forms, giving writing an innate sense of refinement.

CARAN D'ACHE, IN LOVE WITH COLOUR

The play of light on the material... its soft, velvety texture... the precious pigments brought from mysterious places... There has been a genuine love of colours, and the traditions of manufacturing them, in our Geneva workshops ever since our first pencil was produced nearby in 1915.

The fine, smooth leads, the subtly transparent watercolours and the brilliant, deep, light-resistant paints have been developed for creative professionals as well as amateur artists. They all reflect Caran d'Ache's exceptional Swiss Made quality and love of its craft.

As a Maison de Haute Ecriture, we respect nature as well as people. The premium-quality cedar used in our pencils is certified FSC, and our production of leads, pastels and paints carefully follows the principles of sustainable development.

THE ART
OF GIVING

THE ART OF GIVING

The pleasure of offering, of sharing... a feeling that will linger in the memory... a gift is an unforgettable gesture, the seal of an eternally special moment.

Each Caran d'Ache writing instrument captures the emotion of sharing and relating. It is a constant companion that records the important words and makes a perfect personal gift.

The many possibilities for personalising a Caran d'Ache writing instrument or a fine leatherware accessory ensure that it will remain forever faithful to its owner. These gifts, the product of unique expertise, are imbued with the tireless pursuit of excellence, the creativity and the tradition of innovation that has characterised the company since 1915.

In offering a Caran d'Ache creation you are presenting a piece that demonstrates an exceptional manufacturing talent and culture. More than simply a gift, it is an invitation to share your appreciation of life.

THE ART OF CELEBRATING

Congratulating a colleague, marking a special date, rewarding a team, thanking a partner or a client... there are countless occasions for celebration. Caran d'Ache writing instruments represent a set of values that communicate, better than any words, the esteem, the respect and the recognition that lie at the heart of a special relationship.

Fountain pens, roller pens, ballpoints, pencils, mechanical pencils and ink bottles are all developed to a supreme level of quality and refinement that is apparent as soon as their words or lines appear on the paper. It is a unique moment destined to remain forever in the memory of your partners.

EXPERTISE



THE ARTISTIC CRAFTS

ENGRAVING

The fine engraving that characterises Caran d'Ache writing instruments is the product of patient, meticulous work. The company's innovative techniques of milling and engraving with lasers or diamonds make it possible to produce a large variety of outlines and reliefs that bring a design to life by creating a delicate play of light and shadow. Whether it is guillochage or personalised engraving, each piece receives the same attention to detail, making the finished instrument a treasure of refinement.

POLISHING

A soft touch, comfortable writing and perfect design... sometimes sparkling, sometimes matt, each part of these Caran d'Ache products is carefully worked. All the writing instruments finished in precious materials are polished, which is also a very important operation when applying lacquer or Chinese lacquer.

THE UNIQUE EXPERTISE OF THE LACQUER MASTER

A finish that requires exceptional precision, lacquer gloriously enhances the writing instruments with its incomparable brilliance and its large palette of tints that Caran d'Ache is constantly extending. Because preparing and applying lacquer requires such extraordinary skill, the work of the lacquer master is uniquely valuable. It demonstrates the company's commitment to authenticity and excellence in every product it creates.

NOBLE MATERIALS

PRECIOUS METALS: SILVER, RHODIUM, PLATINUM

Caran d'Ache creations in silver or solid gold are systematically controlled by the Federal Office of Metals and certified with its seal. Gold is certainly the metal used in the most beautiful work produced by Caran d'Ache craftsmen. Like real goldsmiths, they sculpt it, decorate it, engrave it and polish it.

But Caran d'Ache also explores other horizons with rhodium, the metal in the platinum family whose hardness and rarity make it ten times as expensive as gold. Extremely strong, it enables writing instruments to keep their brilliance over the years, protecting them from corrosion and rust, as well as abrasion and tarnishing. Rare, pure and inert, rhodium is the most exclusive of the precious metals used by the company.

CHINESE LACQUER

A natural, living product derived from the sap of the *Rhus Verniciflua* tree, Chinese lacquer regularly inspires the most beautiful Caran d'Ache creations. Using traditional expertise inherited from the great oriental masters, the company is one of the very few in the world to have the secret... and the patience. The multiple coats of lacquer are applied over a period of twelve days. Chinese lacquer, which may be natural colour or tinted with pigments of blue, black or red, embellishes lighters and writing instruments in the Varius and Hexagonal collections as well as the Limited Editions.

SUSTAINABLE DEVELOPMENT

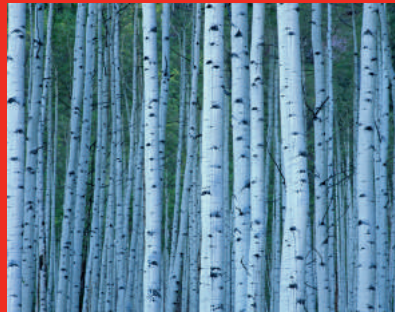

SOCIAL RESPONSIBILITY

Since its foundation in 1915, Caran d'Ache has placed product quality and respect for people at the heart of its policy for growth. In setting up structures able to meet the challenges of the future, the company integrates social, environmental and economic concerns both internally and through regular contacts with all the parties involved in its activities.

THE MANAGEMENT OF QUALITY AND THE QUALITY MANAGEMENT

In 1996, the excellence of the company's production methods was recognised with ISO 9001 certification. Then in 2010, its environmental management was certified ISO 14001.



CONTRIBUTING TO ENVIRONMENTAL PROTECTION

Environment-friendly production methods, careful selection of raw materials, recycling of waste, and energy savings are all imperatives for the company.

With this in mind, Caran d'Ache is upgrading its production facilities and its energy-saving measures: thermal insulation, closed-circuit water recycling, mounting 800m² of solar panels, using compressed bricks of wood shavings from pencil production in the buildings' heating systems, installing cooling towers and a heat exchanger.

SAFETY AND CONTROL OF RAW MATERIALS

Caran d'Ache carefully selects its suppliers and all the materials required to produce its designs, respecting applicable regulations and the strictest safety norms. The objective: to guarantee the traceability and quality of raw materials by closely following the supply chains, particularly for wood and precious stones. All materials we receive are carefully analysed and checked before being used. This stage of the quality management system has two main objectives: to certify the quality of our products and ensure the safety of all those who use them or produce them.

SUSTAINABLE PRODUCTS TO REDUCE WASTE

Caran d'Ache products are not only characterised by their reliability but also their extended lifespan. The brand fits its ballpoint pens with metal cartridges including steel nibs and ballpoints with tungsten carbide, giving them a significantly longer lifespan and thus helping to fight excessive consumption. Guaranteeing a clean line right down to the last drop of ink, the writing capacity of a giant Goliath cartridge is higher than a standard cartridge (around 8 km or 600 A4 pages).

SWISS MADE

Since its foundation, the company's entire range of products has been designed, developed and manufactured in its Geneva workshops. Our "Swiss Made" label guarantees that our customers receive exceptional quality, high precision, unrivalled reliability and robustness, in addition to the refined design, elegance and originality of all our products.



CERTIFICATION OF WOOD

All Caran d'Ache pencils are certified FSC® or PEFC. This means their wood comes from strictly managed forests with guaranteed reforestation programmes.



The mark of responsible forestry

carandache.com/corporate-gifts

Caran d'Ache's iconic Varius collection is the result of our passionate work with materials ; Chinese lacquer, carbon fibre, chain mail, ceramic and more recently genuine rubber echo the silver, rhodium or gold plated attributes of this writing instrument. A rare conjunction of striking design and superb writing comfort, this collection turns the art of handwriting into a daily pleasure.

- Four writing instruments: Fountain pen, roller pen, ballpoint pen and mechanical pencil
- Brass body finished in various materials
- Flexible clip
- Silver, rhodium and gold plated attributes
- International lifetime guarantee
- Made in Switzerland



VARIUS

FOUNTAIN PEN / M – 4490

Nib sizes: *B / F / EF / OM / OB / BB*

Nib: 18 carat gold, rhodium-coated

Fountain pen – piston ink pump or ink cartridge

Cap: screw

Refills: *Chromatics collection ink bottles and cartridges (see refills sheet)*



ROLLER PEN / 4470

Roller pen – ink cartridge

Cap: screw

Refills: *Roller cartridge, fine, blue or black (see refills sheet)*



BALLPOINT PEN / 4480

Ballpoint pen – ink cartridge

Mechanism: push button

Refills: *Goliath cartridge, large, medium or fine (see refills sheet)*



MECHANICAL PENCIL / 4460

Mechanical pencil – 0.7 mm lead

Mechanism: push button

Refills: *Graphite leads 0.7 mm, HB or B and eraser (see refills sheet)*

MINIMUM QUANTITY

Standard: 10 pieces

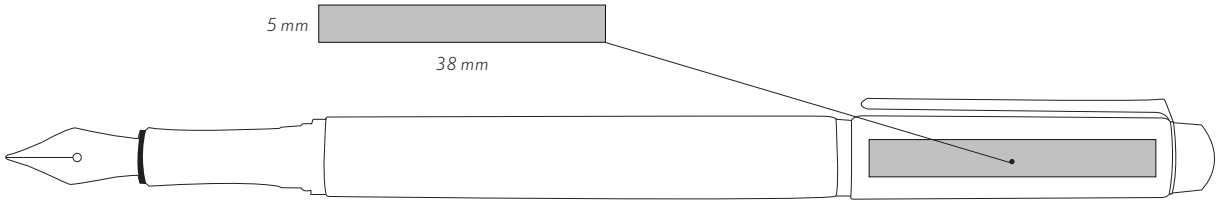

ITEMS 4490. / 4470.

CAP Dim 38x5 mm (not available for .085)

Laser engraving (no colour) / Diamond engraving (no colour)

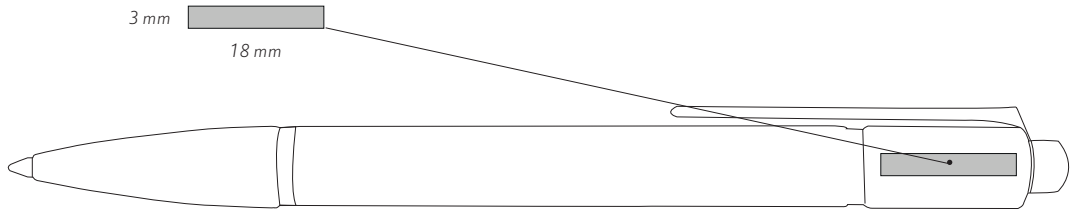

ITEMS 4789. / 4769.

BODY Dim 18x3 mm (not available for .085)

Laser engraving (no colour) / Diamond engraving (no colour)

AVAILABLE MODELS



020 RHO - BLACK CHINESE LACQUER / SILVER-PLATED AND RHODIUM-COATED



018 GOLD PL. - BLACK CHINESE LACQUER / GOLD-PLATED



085 RHO - RUBRACER / SILVER-PLATED AND RHODIUM-COATED



017 RHO - CARBON FIBRE / SILVER-PLATED AND RHODIUM-COATED



109 RHO - BLACK CERAMIC / SILVER-PLATED AND RHODIUM-COATED



014 RHO - COAT OF MAIL / SILVER-PLATED AND RHODIUM-COATED



082 RHO - BLACK COAT OF MAIL / SILVER-PLATED AND RHODIUM-COATED



142 GOLD PL. - EBONY / ROSE GOLD PLATED

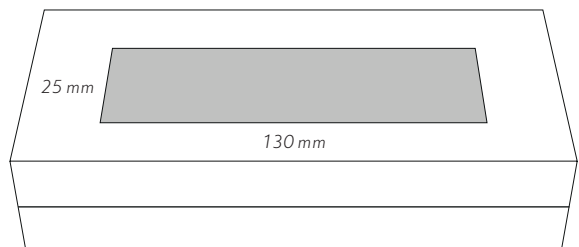

CASE 100010.068

STANDARD

Customisable case: 100010.963

Hot stamping (130x25 mm)

Other cases available, see "the Art of Giving" sheet

Cases: 100013.480 / 100014.400

Sometimes warm and shimmering like a fiery sunset on the waters of the lake, sometimes soft and powdery like the clouds of an uncertain dawn, a palette of subtle tints is the inspiration of the Léman collection. In a wonderland of colours composed of the pigments used in our Fine Arts products, the collection captures the rich chromatic variations that constantly change the face of Lake Léman.

- Four writing instruments: fountain pen, roller pen, ballpoint pen, mechanical pencil
- Body and cap made of thick gauge brass in different colours and finishes
- Articulated clip, using a spring mechanism
- Gold-plated or silver-plated, rhodium-coated finishes
- Lifetime international guarantee
- Swiss Made



LÉMAN

FOUNTAIN PEN / M - 4799

Nib sizes: B / F / BB

Nib: 18 carat gold, rhodium-coated

Fountain pen – piston ink pump or ink cartridge

Cap: screw

Refills: Chromatics collection ink bottles and cartridges (see refills sheet)



ROLLER PEN / 4779

Roller pen – ink cartridge

Cap: screw

Refills: Roller cartridge, fine, blue or black (see refills sheet)



BALLPOINT PEN / 4789

Ballpoint pen – ink cartridge

Mechanism: rotary

Refills: Goliath cartridge, large, medium or fine (see refills sheet)



MECHANICAL PENCIL / 4769

Mechanical pencil – 0.7 mm lead

Mechanism: rotary

Refills: Graphite leads 0.7 mm, HB or B and eraser (see refills sheet)

MINIMUM QUANTITY

Standard:	10 pieces
Other guillochages:	250 pieces *
Other colours:	400 pieces *

* with 6 weeks delivery time

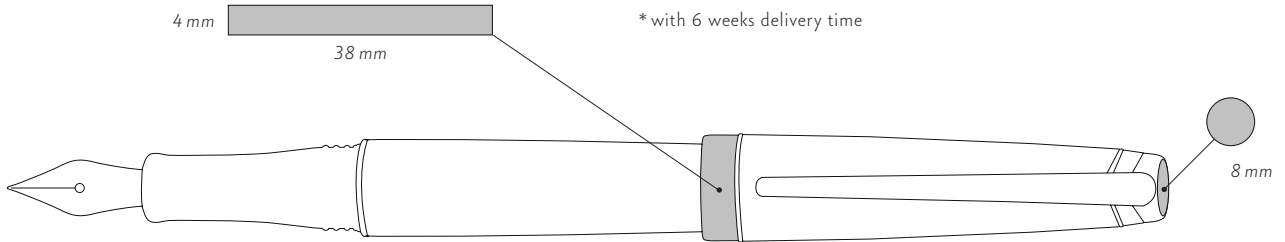

ITEMS 4799. / 4779.

RING Dim: 38x4 mm

Laser engraving (no colour)

BUTTON Ø 8 mm

Laser engraving (no colour) / Pad printing (2 colours)

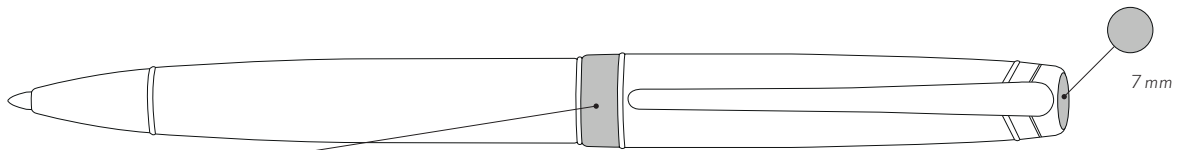

ITEMS 4789. / 4769.

RING Dim: 32x3,5 mm

Laser engraving (no colour)

BUTTON Ø 7 mm

Laser engraving (no colour) / Pad printing (2 colours)

AVAILABLE MODELS

-  **782 RHO** - BLACK / SILVER-PLATED AND RHODIUM-COATED
-  **496 RHO** - BLACK MAT / SILVER-PLATED AND RHODIUM-COATED
-  **282 GOLD PL** - BLACK MAT / GOLD-PLATED
-  **449 RHO** - BLUE MATT / SILVER-PLATED AND RHODIUM-COATED
-  **970 RHO** - RED / SILVER-PLATED AND RHODIUM-COATED
-  **183 RHO** - GREEN / SILVER-PLATED AND RHODIUM-COATED
-  **110 RHO** - LILAC / SILVER-PLATED AND RHODIUM-COATED

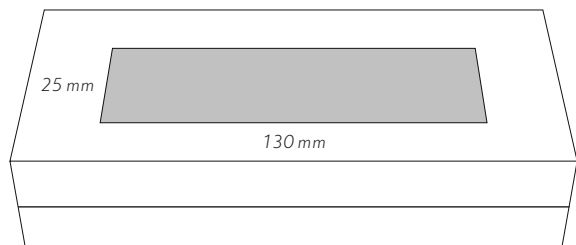

CASE 100010.068

STANDARD

Customisable case: 100010.963

Hot stamping (130x25 mm)

Other cases available, see "the Art of Giving" sheet

Cases: 100013.480 / 100014.400

Sometimes warm and shimmering like a fiery sunset on the waters of the lake, sometimes soft and powdery like the clouds of an uncertain dawn, a palette of subtle tints is the inspiration of the Léman collection. In a wonderland of colours composed of the pigments used in our Fine Arts products, the collection captures the rich chromatic variations that constantly change the face of Lake Léman.

- Four writing instruments: fountain pen, roller pen, ballpoint pen, mechanical pencil
- Body and cap made of thick gauge brass in different colours
- Articulated clip, using a spring mechanism
- Silver-plated, rhodium-coated finishes
- Lifetime international guarantee
- Swiss Made



LÉMAN BICOLOR

FOUNTAIN PEN / M - 4799

Nib sizes: B / F / BB

Nib: 18 carat gold, rhodium-coated

Fountain pen – piston ink pump or ink cartridge

Cap: screw

Refills: Chromatics collection ink bottles and cartridges (see refills sheet)



ROLLER PEN / 4779

Roller pen – ink cartridge

Cap: screw

Refills: Roller cartridge, fine, blue or black (see refills sheet)



BALLPOINT PEN / 4789

Ballpoint pen – ink cartridge

Mechanism: rotary

Refills: Goliath cartridge, large, medium or fine (see refills sheet)



MECHANICAL PENCIL / 4769

Mechanical pencil – 0.7 mm lead

Mechanism: rotary

Refills: Graphite leads 0.7 mm, HB or B and eraser (see refills sheet)

MINIMUM QUANTITY

Standard:	10 pieces
Other guillochages:	250 pieces *
Other colours:	400 pieces *

* with 6 weeks delivery time

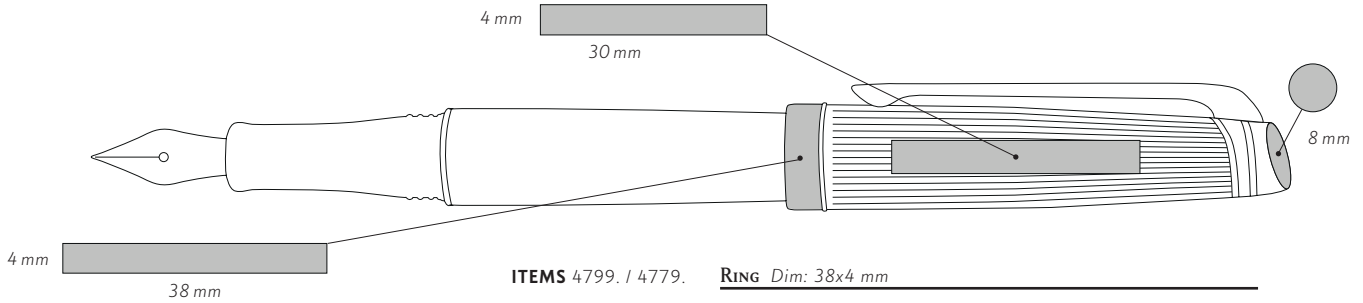

ITEMS 4799. / 4779.

RING Dim: 38x4 mm

Laser engraving (no colour)

BUTTON Ø 8 mm

Laser engraving (no colour) / Pad printing (2 colours)

CAP Dim: 30x4 mm

Laser engraving (no colour) / Diamond engraving (no colour)

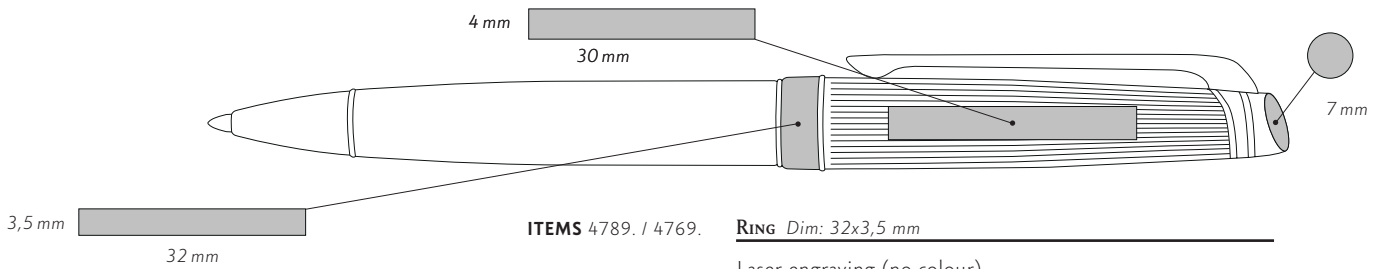

ITEMS 4789. / 4769.

RING Dim: 32x3,5 mm

Laser engraving (no colour)





BUTTON Ø 7 mm

Laser engraving (no colour) / Pad printing (2 colours)

CAP Dim: 30x4 mm

Laser engraving (no colour) / Diamond engraving (no colour)

AVAILABLE MODELS

-  **289 RHO** - BICOLOR BLACK / SILVER-PLATED AND RHODIUM-COATED
-  **001 RHO** - BICOLOR WHITE / SILVER-PLATED AND RHODIUM-COATED
-  **530 RHO** - BICOLOR SAFFRON / SILVER-PLATED AND RHODIUM-COATED
-  **171 RHO** - BICOLOR TURQUOISE / SILVER-PLATED AND RHODIUM-COATED

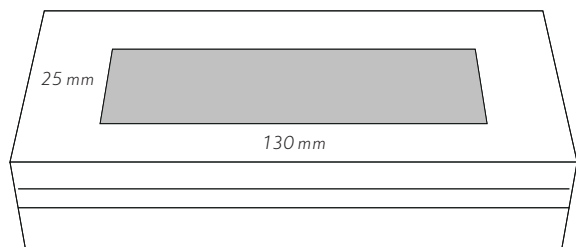

CASE 100010.068

STANDARD

Customisable case: 100010.963

Hot stamping (130x25 mm)

Other cases available, see "the Art of Giving" sheet

Cases: 100013.480 / 100014.400

Both its name and shape have long been unmistakable emblems of Caran d'Ache expertise.

The Ecridor Collection is composed of seven lines each with guillochage inspired by a different world. Whatever the inspiration selected, each version remains faithful to the key elements of the Ecridor's success.

- Four writing instruments: fountain pen, roller pen, ballpoint pen, mechanical pencil
- Hexagonal body made of brass
- Flexible clip
- Gilt, platinum or silver-plated, rhodium-coated finishes
- Lifetime international guarantee
- Swiss Made



ECRIDOR

FOUNTAIN PEN / M - 958

Nib sizes: B / F

Nib: Steel

Fountain pen – piston ink pump or ink cartridge

Cap: click-in

Refills: Chromatics collection ink bottles and cartridges (see refills sheet)

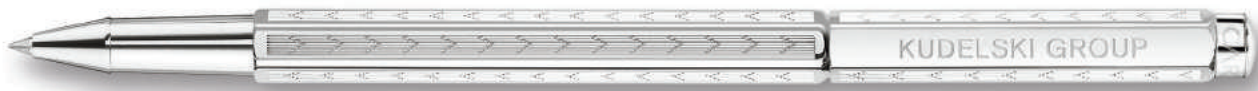

ROLLER PEN / 838

Roller pen – ink cartridge

Cap: click-in

Refills: Roller cartridge, fine, blue or black (see refills sheet)



BALLPOINT PEN / 890

Ballpoint pen – ink cartridge

Mechanism: push button

Refills: Goliath cartridge, large, medium or fine (see refills sheet)



MECHANICAL PENCIL / 4

Mechanical pencil – 0.7 mm lead

Mechanism: push button

Refills: Graphite leads 0.7 mm, HB or B and eraser (see refills sheet)

TECHNICAL SHEET PERSONALISATION

MINIMUM QUANTITY

Standard face:	face 4
Diamond engraving:	10 pieces*
Laser engraving:	10 pieces**
Milling cutter engraving:	30 pieces**
Pad printing on button:	30 pieces**
Other engraving:	70 pieces**
Other free space / faces:	70 pieces**

* 2 weeks delivery time
** 3 weeks delivery time

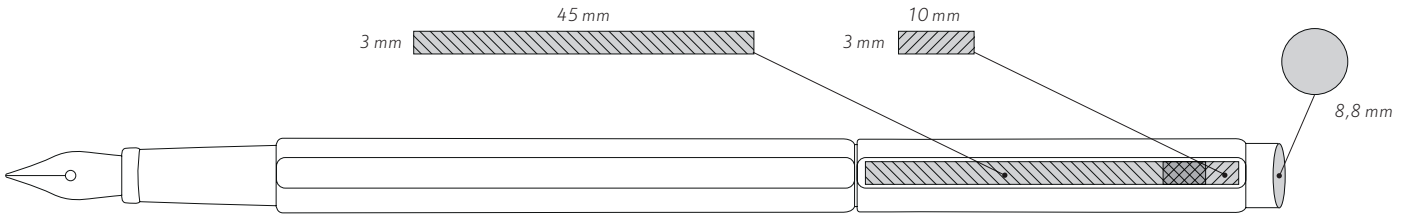

ITEMS 958. / 838.

BUTTON Ø 8,8 mm

Laser engraving (no colour) / Pad printing (5 colours)

CAP Dim: 45x3 mm or 10x3 mm

Laser engraving (no colour) / Diamond engraving (no colour)

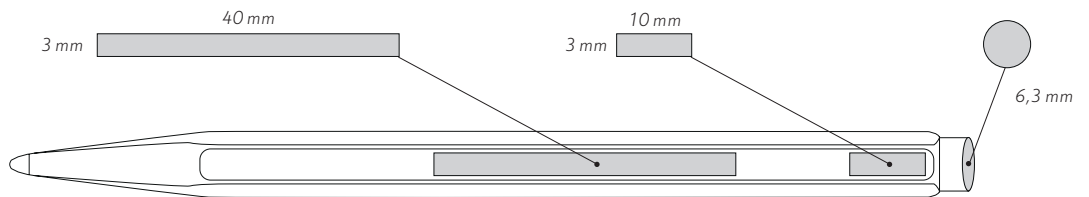

ITEMS 890. / 4.

BUTTON Ø 6,3 mm

Laser engraving (no colour) / Pad printing (5 colours)

BODY Dim: 40x3 mm or 10x3 mm

Laser engraving (no colour) / Diamond engraving (no colour)

AVAILABLE MODELS



377 PAL - CUBRIK



286 PAL - CHEVRON
(ARTIST 42.786)



208 GILD - CHEVRON



487 PAL - RETRO



349 PAL - HERITAGE



366 PAL - LIGNES URBAINES
(ONLY BALLPOINT PEN AND MECHANICAL PENCIL)



368 GILD - LIGNES URBAINES
(ONLY BALLPOINT PEN AND MECHANICAL PENCIL)



516 PAL - GOLF



515 PAL - MATCH POINT

OTHER GUILLOCHAGES AVAILABLE ON DEMAND
ARLEQUIN, DAMIER, FLORENTIN, PARALLÈLE, ROTATION, TYPE 55

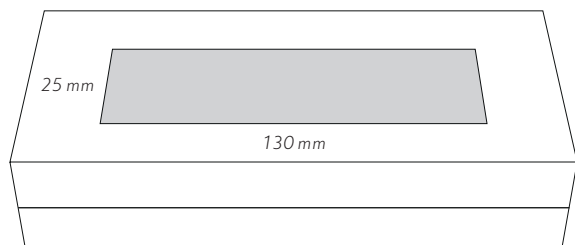

CASE 100010.068

STANDARD

Customisable case: 100010.963

Hot stamping (130x25 mm)

Other cases available, see "the Art of Giving" sheet

Cases: 100013.480 / 100014.400

Because the most effective icons are those that adapt to changing times, Caran d'Ache has carefully revisited one of its most famous collections, introduced in the 1970's. The elegant Madison retains its slender rounded body but has been given a jointed clip. It is a true classic, rooted in its time.

- Four writing instruments: fountain pen, roller pen, ballpoint pen, mechanical pencil
- Body and cap made of thin gauge brass, available in different finishes
- Articulated clip, using a spring mechanism
- Gold-plated or silver-plated, rhodium-coated finishes
- Lifetime international guarantee
- Swiss Made



MADISON

FOUNTAIN PEN / M - 4690

Nib sizes: B / F
 Nib: 18 carat gold, rhodium-coated
 Fountain pen – piston ink pump or ink cartridge
 Cap: click-in

Refills: Chromatics collection ink bottles and cartridges
 (see refills sheet)



ROLLER PEN / 4670

Roller pen – ink cartridge
 Cap: click-in

Refills: Roller cartridge, fine, blue or black (see refills sheet)



BALLPOINT PEN / 4680

Ballpoint pen – ink cartridge
 Mechanism: push button

Refills: Goliath cartridge, large, medium or fine (see refills sheet)



MECHANICAL PENCIL / 4660

Mechanical pencil – 0.7 mm lead
 Mechanism: push button

Refills: Graphite leads 0.7 mm, HB or B and eraser (see refills sheet)

TECHNICAL SHEET PERSONALISATION

MINIMUM QUANTITY

Standard:	10 pieces
With pad printing:	30 pieces *
Other guillochages:	70 pieces **
Other colours:	400 pieces ***

* with 3 weeks delivery

** with 4 weeks delivery

*** with 6 weeks delivery

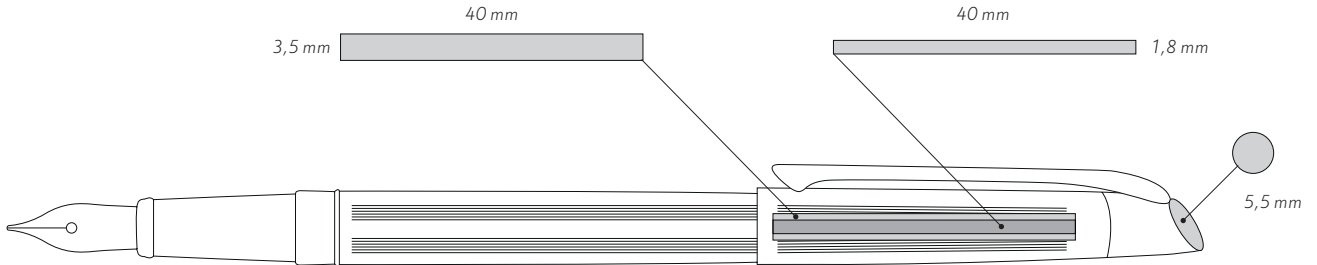

ITEMS 4690. / 4670. **BUTTON** Ø 5.5 mm

Laser engraving (no colour) / Pad printing (2 colours)

CAP Dim: 40x1.8 mm or 40x3.5 mm

Laser engraving (no colour) / Diamond engraving (no colour)

Milling cutter engraving (no colour)

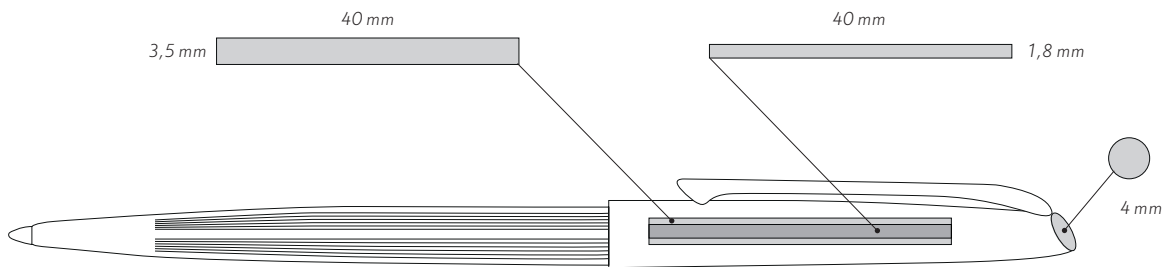

AVAILABLE MODELS

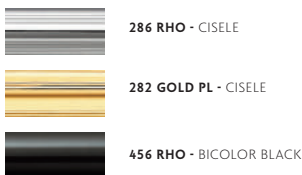

ITEMS 4680. / 4660. **BUTTON** Ø 4 mm

Laser engraving (no colour) / Pad printing (2 colour)

CAP Dim: 40x1.8 mm et 40x3.5 mm

Laser engraving (no colour) / Diamond engraving (no colour)

Milling cutter engraving (no colour)

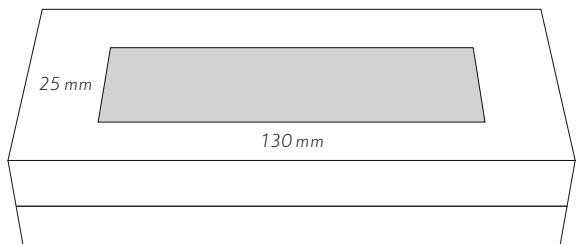

CASE 100010.068 **STANDARD**

Customisable case: 100010.963

Hot stamping (130x25 mm)

Other cases available, see "the Art of Giving" sheet

Cases: 100013.480 / 100014.400

When Fine Writing instruments adopt high technology the result is the birth of a unique collection: RNX.316. In its name, RNX indicates its combination of two body shapes: Round aNd heXagonal. These are emblematic of the Caran d'Ache collections – easy to hold in the fingers for precise control of handwriting – in a new design that is immediately appealing.

- Four writing instruments: fountain pen, roller pen, ballpoint pen, mechanical pencil
- Body and cap made of steel 316L, polished finish
- Flexible clip
- Innovative system for changing the ink cartridge
- Ingenious "click-in" system for closing the pen
- Lifetime international guarantee
- Swiss made



RNX.316 PVD BLACK VERSION

FOUNTAIN PEN / M - 4590.080

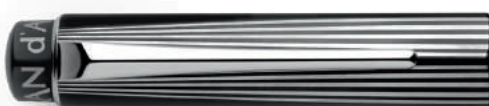

Nib sizes: B - .090 F - .070

Nib: Steel black PVD-coated

Fountain pen – Innovative system for changing the cartridge

Cap: Ingenious "click-in" system for closing the pen

Refills: Chromatics collection ink bottles and cartridges (see refills sheet)



ROLLER PEN / 4570.080

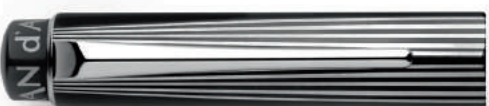

Roller pen – Innovative system for changing the cartridge

Cap: Ingenious "click-in" system for closing the pen

Refills: Roller cartridge, fine, blue or black (see refills sheet)



BALLPOINT PEN / 4580.080

Ballpoint pen – ink cartridge

Mechanism: push button

Refills: Goliath cartridge, large, medium or fine (see refills sheet)



MECHANICAL PENCIL / 4560.080

Mechanical pencil – 0.7 mm lead

Mechanism: push button

Refills: Graphite leads 0.7 mm, HB or B and eraser (see refills sheet)

MINIMUM QUANTITY

Standard: 10 pieces

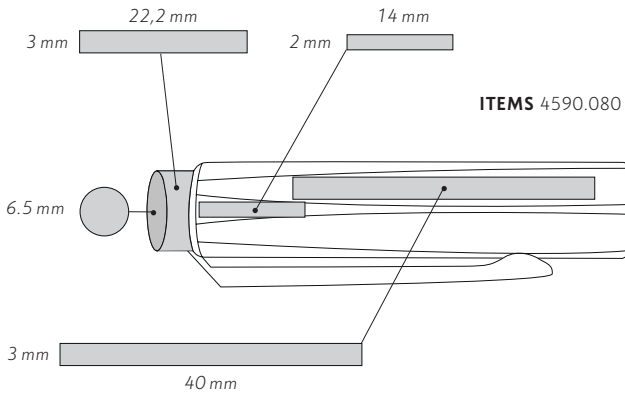

ITEMS 4590.080 / 4570.080

BUTTON Ø 6.5 mm or Dim: 22.2x3 mm

Laser engraving (no colour)

CAP Dim: 40x3 mm or 14x2 mm

Laser engraving (no colour) / Diamond engraving (no colour)

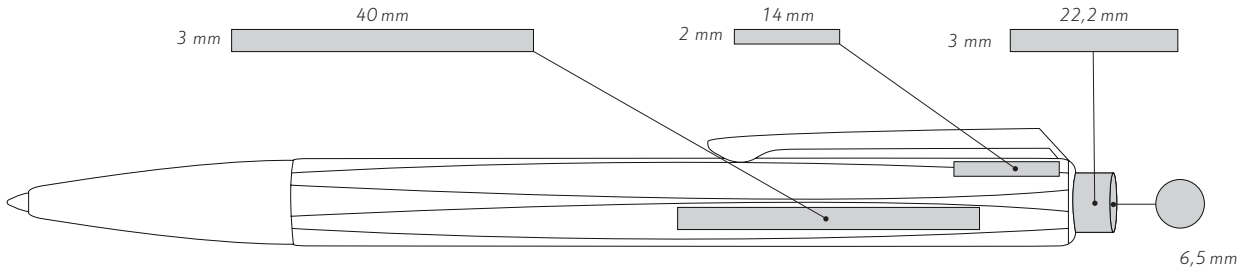

ITEMS 4580.080 / 4560.080

BUTTON Ø 6.5 mm or Dim 22.2x3 mm

Laser engraving (no colour)

BODY Dim: 40x3 mm or 14x2 mm

Laser engraving (no colour) / Diamond engraving (no colour)

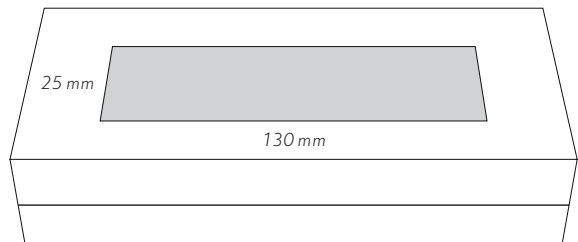

CASE 100010.068

STANDARD

Customisable case: 100010.963

Hot stamping (130x25 mm)

Other cases available, see "the Art of Giving" sheet

Cases: 100013.480 / 100014.400

TECHNICAL SHEET ALCHEMIX

With a bold fusion of materials and design, the Alchemix collection is a skilful combination of elements. Pure outlines, high-tech materials... Alchemix is the perfect amalgam of power, strength and elegance.

This unique formula created by Caran d'Ache reveals a universe with a rare intensity, a writing instrument that is both precise and reliable.

- Two writing instruments: ballpoint pen, mechanical pencil
- Hexagonal body in aluminium
- Push button
- Flexible steel clip
- Decoration applied by immersion or electrostatic powder spraying
- Different finishes available: brilliant polished chrome, matt chrome
- Swiss Made



ALCHEMIX

BALLPOINT PEN / 4880

Ballpoint pen – ink cartridge

Mechanism: push button

Refills: Goliath cartridge, large, medium, fine (see refills sheet)



MECHANICAL PENCIL / 4860

Mechanical pencil – 0.7 mm lead

Mechanism: push button

Refills: Graphite leads 0.7 mm, HB or B (see refills sheet)



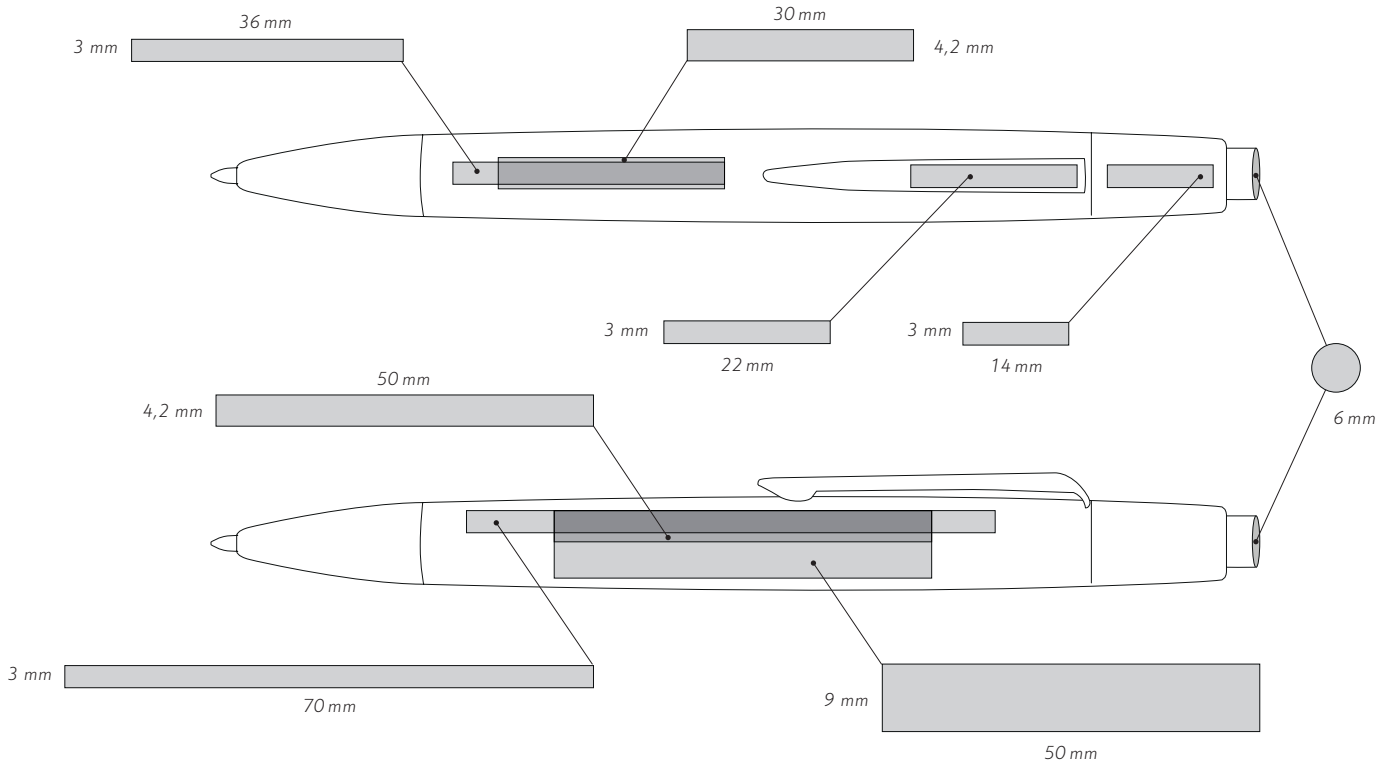

MINIMUM QUANTITY

Standard :	30 pieces*
Other colours :	on request
Other metallic colours:	on request

*3 weeks delivery time



AVAILABLE MODELS

-  **496** - CARBON BRILLIANT POLISHED CHROME TRIM
-  **495** - WENGE MATT CHROME TRIM
-  **109** - RUBBER MATT CHROME TRIM
Personalisation on body not available
-  **140** - METALLIC BLUE BRILLIANT POLISHED CHROME TRIM
-  **409** - METALLIC BLACK BRILLIANT POLISHED CHROME TRIM

OPTIONAL TRIMS EXCEPT FOR WENGE AND CARBON

ITEMS 4880. / 4860.

BUTTON Ø 6 mm

Pad printing (2 colours)

CAP Dim: 14x3 mm

Pad printing (1 colour)

CLIP Dim: 22x3 mm

Laser engraving (no colour) / Pad printing (1 colour, black)

BODY Dim: 50x9 mm, 50x4.2 mm, 70x3 mm, 30x4.2 mm or 36x3 mm

Pad printing (6 colours) /

Laser engraving (except for .496 / .495) (no colour)



LEATHERETTE POUCH 100013.348

STANDARD

Non-customisable

Other pouches available, see "Maroquinerie" sheet 100013.347

ORIGINAL BLACK SLIM PACK 100014.130

STANDARD

Customisable, see "Packaging" sheet

The 849 is genuinely a cult object, both smart and informal, with its aluminium body distinguished by its hexagonal shape: six facets of a unique temperament that make it an iconic ballpoint suited to all occasions.

Revealing some new facets of its personality, the famous 849 line of pens is now enhanced by a very appealing, highly practical mechanical pencil. Light yet strong, the 844 sits very comfortably in the hand.

- Two writing instruments: ballpoint pen, mechanical pencil
- Hexagonal body in aluminium
- Flexible clip
- Extremely resistant push button mechanism
- Classic or fantasy colours applied by electrostatic powder spraying
- Swiss Made



849.

BALLPOINT PEN

Ballpoint pen – ink cartridge
 Touchscreen cap
 With nickel-coated clip and button
 Refills: Goliath cartridge, large, medium or fine (see refills sheet)



849.

BALLPOINT PEN

Ballpoint pen – ink cartridge
 With nickel-coated clip and button
 Mechanism: push button
 Refills: Goliath cartridge, large, medium, fine (see refills sheet)



849.

BALLPOINT PEN

Ballpoint pen – ink cartridge
 With gilded clip and button
 Mechanism: push button
 Refills: Goliath cartridge, large, medium, fine (see refills sheet)



844.

MECHANICAL PENCIL

Mechanical pencil – 0.7 mm lead
 With nickel-coated clip and button
 Mechanism: push button
 Built-in eraser and spare supply of leads
 Refills: Graphite leads 0.7 mm, HB or B and eraser (see refills sheet)

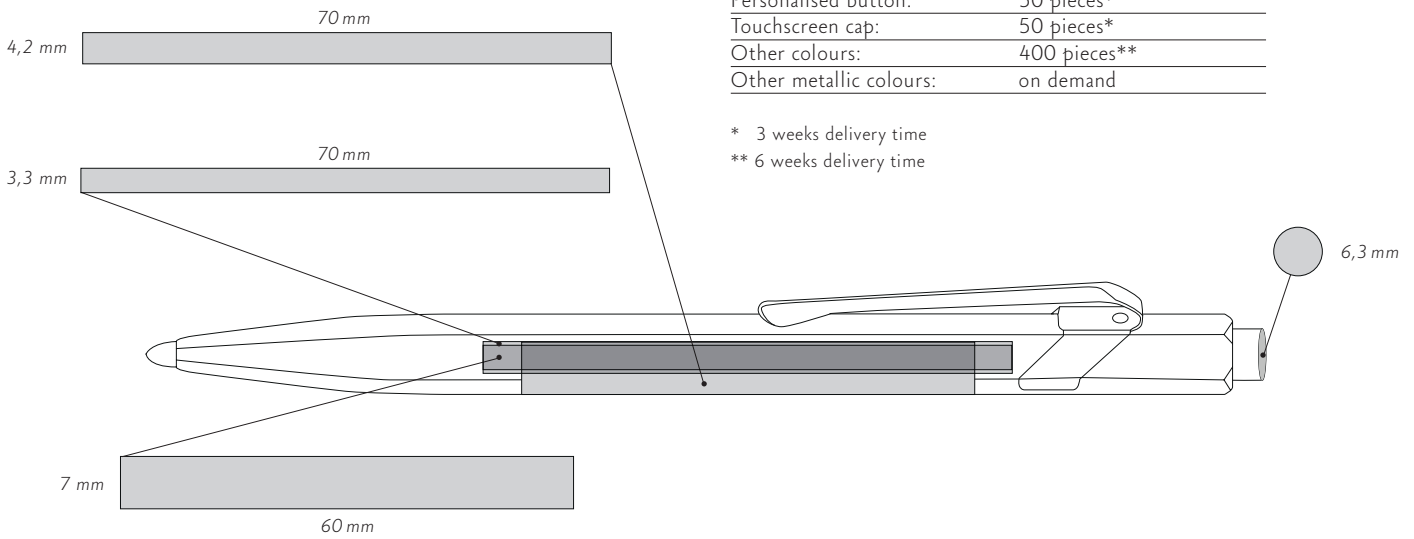

MINIMUM QUANTITY

Standard colours:	50 pieces*
Personalised button:	50 pieces*
Touchscreen cap:	50 pieces*
Other colours:	400 pieces**
Other metallic colours:	on demand

* 3 weeks delivery time
 ** 6 weeks delivery time

ITEMS 849. / 844.

BUTTON Ø 6.3 mm (except 844.)

Laser engraving (no colour) / Pad printing (5 colours)

BODY Dim: 70x4.2 mm ou 60x7 mm

Pad printing (5 colours)

METAL-X MODELS Dim: 70x3.3 mm

Laser engraving (no colour)

NO STANDARD PACKAGING

Other packaging available, see "Packaging" Sheet
 100009.453 / 100008.715 / 100010.106 /
 100004.064 / 100011.711 / 100009.453 /
 100010.957 / 100008.495

AVAILABLE MODELS



*ONLY AVAILABLE IN SLIM PACK

CLIP / BUTTON AVAILABLE IN NICKEL-COATED OR GILDED FINISH (EXCEPT FOR BRUT ROSÉ AND GOLDBAR MODELS)

FICHE TECHNIQUE 888 INFINITE

The 888 INFINITE® collection combines the pleasures of writing with our expertise in colours. Its hexagonal body made of plastic displays bright hues as a rainbow spectrum. Fitted with the SwissRide® cartridge, the 888 INFINITE® offers remarkable smoothness and flow for an unmatched writing comfort.

- Two writing instruments: ballpoint pen and mechanical pencil
- Hexagonal body and clip in synthetic resin available in various colours
- Push-button mechanism
- SwissRide® cartridge with an innovative ink system which provides extreme writing comfort and an incomparably smooth feel
- Made in Switzerland



888.

BALLPOINT PEN

Ballpoint pen – ink cartridge

Mecanism : push-button

Refills: SwissRide® cartridge (see refills sheet)



884.

MECHANICAL PENCIL

Mechanical pencil – Graphite leads 0.7mm

Refills: Built-in eraser and spare supply of leads (see refills sheet)

MINIMUM QUANTITY

Standard colours: 200 pieces*
 Other colours: 1000 pieces**

* 3 weeks delivery time
 ** 8 weeks delivery time

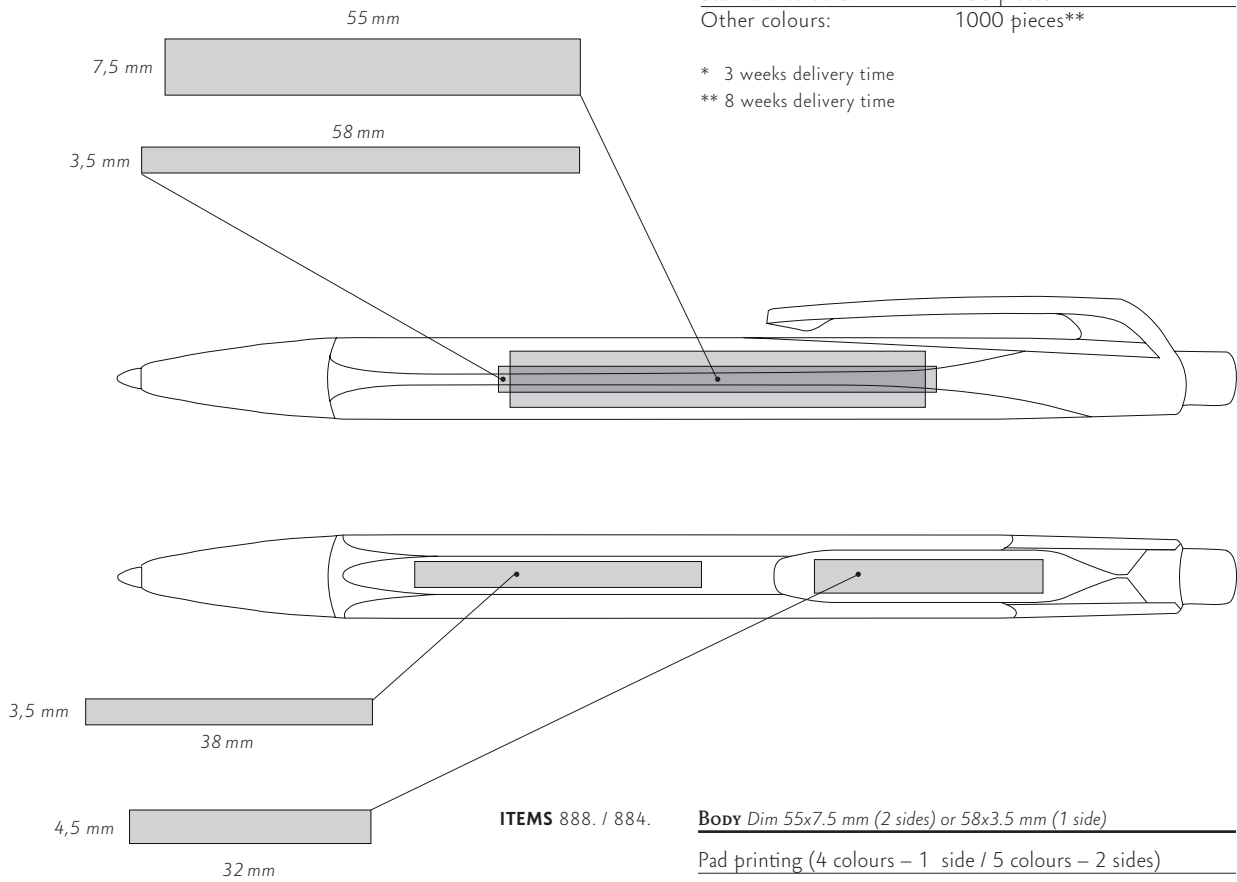

ITEMS 888. / 884.

BODY Dim 55x7.5 mm (2 sides) or 58x3.5 mm (1 side)

Pad printing (4 colours – 1 side / 5 colours – 2 sides)

SWISS CROSS MODEL Dim 32x4.5 mm or 38x3.5 mm

Pad printing (5 colours)

NO STANDARD PACKAGING

Other packaging available (see packaging sheet)
 100009.468 / 100010.105 / 100005.496

AVAILABLE MODELS 888. / 884.

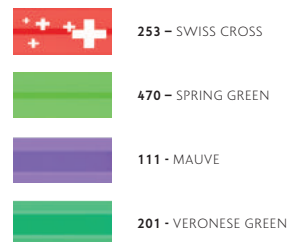
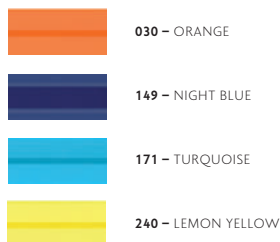

TECHNICAL SHEET FIXPENCIL

The history of the Caran d'Ache Fixpencil® starts in 1929 when it was invented by an engineer in Geneva. It was launched on the market one year later by Caran d'Ache and became a global success. The Fixpencil® was the world's first mechanical pencil, entirely metallic and fitted with a clutch mechanism.

- Fixpencil® - clutch mechanism
- Hexagonal body in aluminium
- Flexible clip
- Lead sharpener incorporated in the push button
- Swiss Made



FIXPENCIL

JUNIOR LINE / 884.

Fixpencil – Graphite 2 mm leads
Mechanism: push button



CLASSIC LINE / 22.

Fixpencil – Graphite 2 mm leads
Mechanism: push button



CLASSIC LINE / 3.

Fixpencil – Graphite 3 mm leads
Mechanism: push button

MINIMUM QUANTITY

Standard:	50 pieces*
Other colours:	400 pieces**
Other Metallic colours:	on request

* 3 weeks delivery time

** 6 weeks delivery time

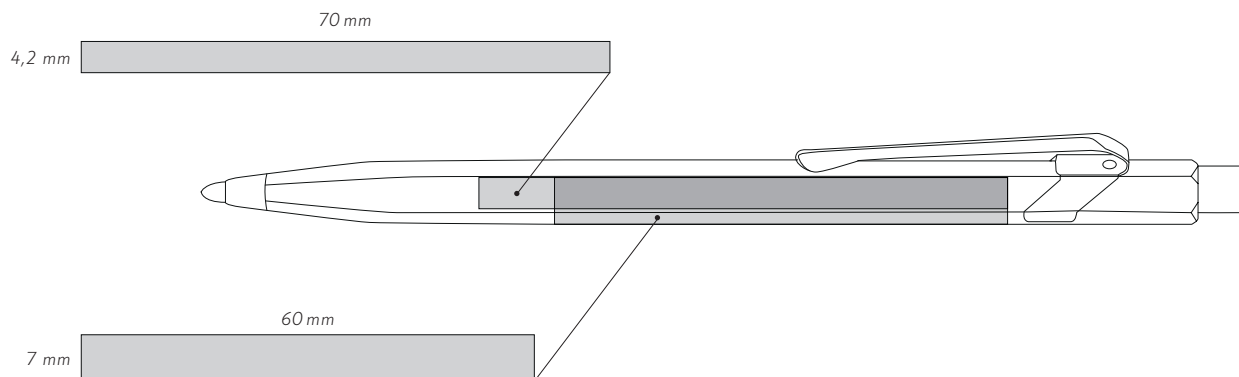

ITEMS 3. / 22. / 884. **Body** Dim: 70x4.2 mm (1 side) or 60x7 mm (2 sides)

Pad printing (5 colours)

AVAILABLE MODELS

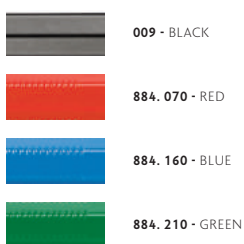

PUSH BUTTON COLOUR (EXCEPT 884.)

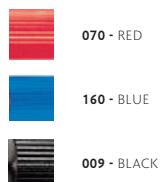

NO STANDARD PACKAGING

Other packaging available, see "Packaging" Sheet
100009.453 / 100010.106 / 100004.064

TECHNICAL SHEET GRAPHITE PENCIL

Indeed for artistic and technical drawing or in the office, graphite pencils are produced with leads of superior quality. The cedar woods of the pencils is FSC® certified, contributing to sustainable forest management.

- Made of cedar wood or beech wood from Swiss Jura forest (Swiss Wood)
- Wood from managed forests
- HB lead
- Body in FSC® wood (excepted: 341.102 / 341.101 / 211)
- High quality leads
- Swiss Made



348.272 **HEXAGONAL PENCIL SWISS WOOD**
 Beech wood from Swiss Jura forest
 SWISS WOOD Caran d'Ache stamping
 Red cap decorated with a Swiss cross.
 HB lead
 Matt water-based varnish



353. **HEXAGONAL PENCIL**
 Touchscreen cap / Aqueous varnish



341.102 **HEXAGONAL PREMIUM BLACK PENCIL**
 Matt lacquered / Capsule / HB lead / Solvent varnish

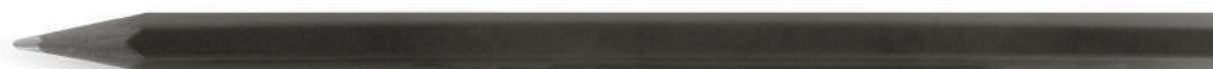

341.101 **HEXAGONAL PREMIUM BLACK PENCIL**
 Matt lacquered / HB lead / Solvent varnish



341. **HEXAGONAL PENCIL**
 Without eraser / HB lead / Aqueous varnish



351. **HEXAGONAL PENCIL**
 With eraser / HB lead / Aqueous varnish



3737. **ROUND PENCIL**
 With or without eraser / HB lead / Aqueous varnish



211. **CARPENTER PENCIL**
 Medium lead / Solvent varnish

TECHNICAL SHEET PERSONALISATION

MINIMUM QUANTITY

Standard:	500 pieces
With eraser:	1000 pieces
With capsule:	500 pieces*
With touchscreen cap:	500 pieces
Other CdA colours or mat colours:	5000 pieces
Other colours:	20000 pieces
Packaging light colours:	288 pieces
Packaging dark colours:	144 pieces
Carpenter packaging:	72 pieces

* Compulsory for white 001 and reference 348.272

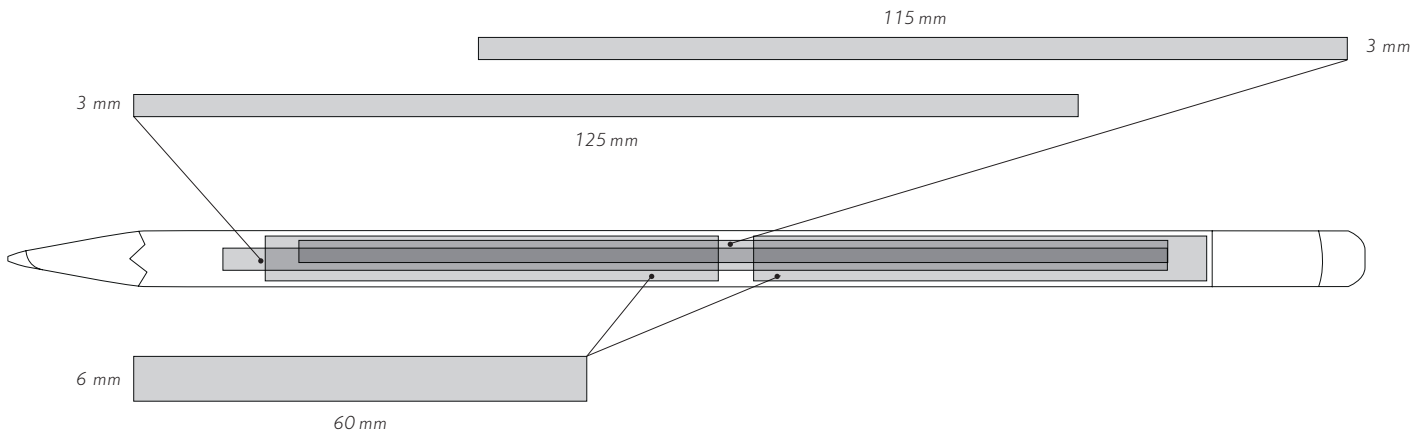

ITEMS 341. / 351. / 348.272

Body

125x3 mm, Silk screen printing (1 colour)*
60x6 mm, Pad printing (2 colours)
115x3 mm, Hot stamping (1 colour)* (Helvetica, height: 2mm)
60x6 mm, Relief stamping (1 colour)*

*Silk screen printing, hot and relief stamping
not available for 348.272

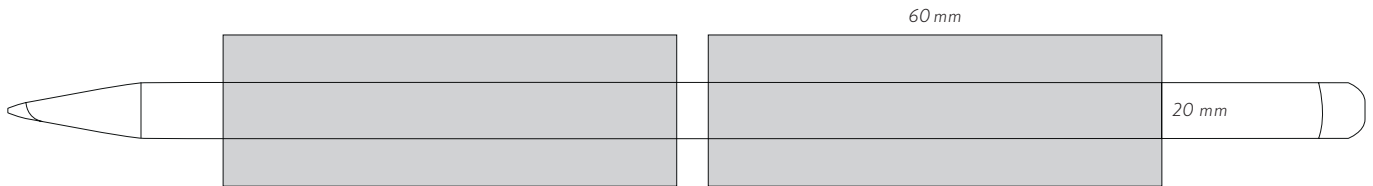

ITEMS 3730.

Body

(2x60)x20 mm, Silk screen printing (1 colour)
60x20 mm, Silk screen printing (2 colours)

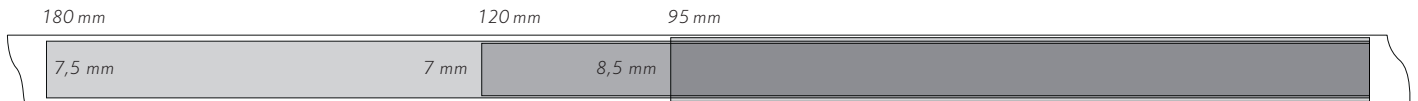

NO STANDARD PACKAGING

Other packaging available, see "Packaging" Sheet
100001.901 / 100005.539

ITEMS 211.

Body Length: 25 cm

180x7.5 mm, Silk screen printing (1 colour)
95x8.5 mm, Silk screen printing (2 colours)
120x7 mm, Hot stamping (1 colour)

AVAILABLE MODELS

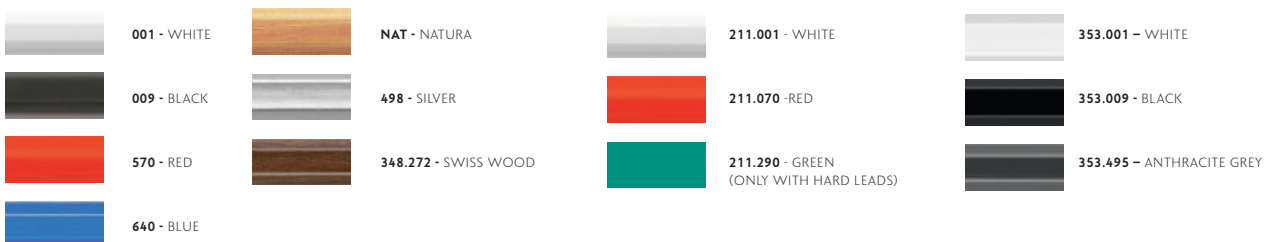

TECHNICAL SHEET REFILLS

Writing comfort also applies to refills and particularly to the quality of the inks chosen by Caran d'Ache. A strict flow control ensures smooth, even handwriting with clean lines, in a large range of colours, over a long period. It is a technology that meets the very highest quality standards – the only standards recognised at Caran d'Ache.

- Ink conforms to ISO 12757-1-2 standards
- Caran d'Ache ballpoint pen cartridges have a stainless-steel tip housing a rotating ball
- Highly precise assembly of the ball into its seat in order to guarantee regular smooth writing
- The ink flow of each cartridge is tested before it is approved for sale
- Caran d'Ache leads have a high resistance to breakage and provide smooth writing action



INK BOTTLE: DELICATE GREEN /
8011.221

FOUNTAIN PENS

To satisfy the writing preferences of as many people as possible, Caran d'Ache fountain pens can be fitted with a piston ink pump or can accept ink cartridges.



INK BOTTLE: COSMIC BLACK /
8011.009



INK BOTTLE: IDYLIC BLUE /
8011.140



INK BOTTLE: MAGNETIC BLUE /
8011.149



INK BOTTLE: HYPNOTIC TURQUOISE /
8011.191



INK BOTTLE: INFRA RED /
8011.070



INK BOTTLE: DIVINE PINK /
8011.080



INK BOTTLE: ELECTRIC ORANGE /
8011.052



INK BOTTLE: ORGANIC BROWN /
8011.049



INK BOTTLE: VIBRANT GREEN /
8011.210



INK BOTTLE: ULTRA VIOLET /
8011.099



INK BOTTLE: INFINITE GREY /
8011.005



CARTRIDGE (6 PIECES)

8021.005 (INFINITE GREY) / 8021.009 (COSMIC BLACK) /
8021.049 (ORGANIC BROWN) / 8021.052 (ELECTRIC
ORANGE) / 8021.070 (INFRA RED) / 8021.080 (DIVINE
PINK) / 8021.099 (ULTRAVIOLET) / 8021.140 (IDYLIC BLUE)
/ 8021.149 (MAGNETIC BLUE) / 8021.191 (HYPNOTIC
TURQUOISE) / 8021.210 (VIBRANT GREEN) /
8021.221 (DELICATE GREEN)



GOLIATH CARTRIDGE

Large 8422.260 (BLUE) / 8428.109 (BLACK)

Medium 8422.000 (BLUE) / 8428.000 (BLACK) / 8420.000 (RED) / 8418.000 (GREEN)

Fine 8422.160 (BLUE) / 8428.009 (BLACK) / 8420.070 (RED)



SWISSRIDE® CARTRIDGE, MEDIUM

8522.000 (BLUE) / 8528.000 (BLACK)

BALLPOINT PENS

Caran d'Ache ballpoint pens are also carefully designed to provide great writing comfort. They are fitted with the famous Goliath giant cartridge that has the writing capacity to cover 600 A4 pages! To make it a particularly easy refill to use, the ball is fitted into its seat with great precision and its stainless steel and tungsten carbide composition enables it to lay down intense, regular lines on the paper. It is available in three writing widths: fine medium and large.

Developed for the 888 Infinite ballpoint pen, the SwissRide® cartridge provides an incomparably smooth feel and extreme writing comfort.

ROLLER PENS

Roller pen refills are produced in a similar way to the Goliath cartridge but contain a more fluid ink. The result is a level of writing comfort that is almost identical to a fountain pen. Roller pens can also accept fibre tip cartridges available in medium and fine sizes.



CARTRIDGE FINE

8222.160 (BLUE) / 8228.009 (BLACK)



FIBRE CARTRIDGE, MEDIUM

8122.000 (BLUE) / 8128.000 (BLACK)



FIBRE CARTRIDGE, FINE

8122.160 (BLUE) / 8128.009 (BLACK)



ERASERS

505.000 ECRIDOR, RNX.316

506.000 LÉMAN

MECHANICAL PENCILS

Caran d'Ache expertise extends to mechanical pencils. They take leads of 0.5mm or 0.7mm which are advanced by a push button that is particularly easy to operate. Since the company is very familiar with the needs of artists, they are not forgotten: a choice of 2 mm coloured leads is available for them.



GRAPHITE LEADS 0.5 MM - 12-PIECE PACK

6705.350 60 MM HB

6705.351 60 MM B

GRAPHITE LEADS 0.7 MM - 12-PIECE PACK

6707.350 60 MM HB

6707.351 60 MM B

Because genuine elegance is holistic, Caran d'Ache has developed an exclusive range of accessories matched to its collections. This leatherware offers the extra touch that creates a perfect, personalised gift.

- Leather pouches



LEATHER POUCH 1 PEN / 100006.705

Madison

Ecridor

Dunas

849 / 844



LEATHER POUCH 2 PENS / 100008.220

Madison

Ecridor

RNX.316 (except for fountain pen and roller pen)

849 / 844



LEATHER POUCH 1 PEN / 100013.344

Madison

Ecridor



LEATHER POUCH 1 PEN / 100013.347

Alchemix

MINIMUM QUANTITY

Standard: 10 pieces

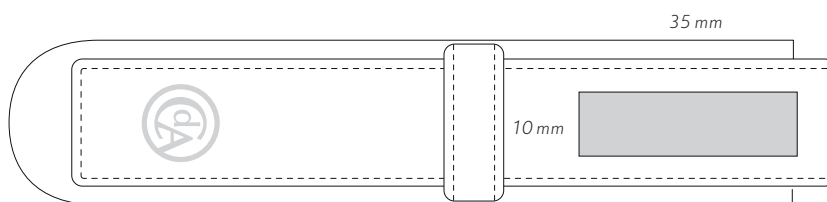

ITEM 100006.705 **Tab Dim:** 10x35 mm

Hot stamping

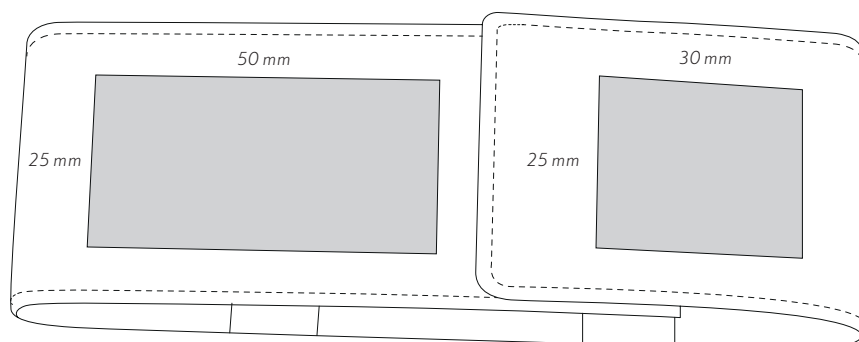

ITEM 100008.220 **Body Dim:** 25x50 mm

Hot stamping

Tab Dim: 25x30 mm

Hot stamping

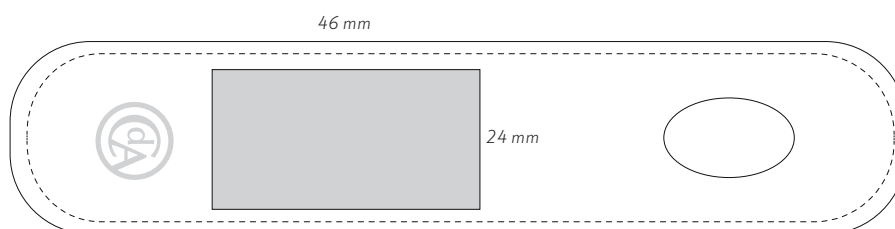

ITEM 100013.344 / 100013.347 **Body Dim:** 24x46 mm

Hot stamping (gold, silver, white, blind)

For a perfect presentation of your gifts, Caran d'Ache provides top range wooden boxes with a high-gloss black lacquer finish. Protected in their packaging, your personalised writing instruments stand out beautifully.

- Wooden boxes, high-gloss black lacquer
- 2 sizes available, for 1 to 4 writing instruments
- Delivered with a cloth and a protective box



BLACK LACQUERED WOODEN BOX 100013.480

Size S *Dim: 195x100x65 mm*

For 1 or 2 writing instruments



BLACK LACQUERED WOODEN BOX 100014.400

Size M *Dim: 220x160x90 mm*

For 1, 2, 3 or 4 writing instruments

SERVICES PERSONALISATION

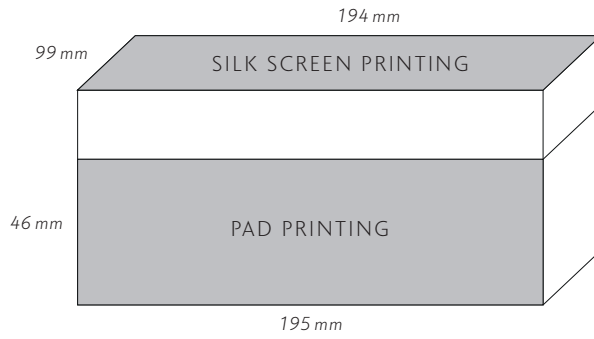

SIZE S

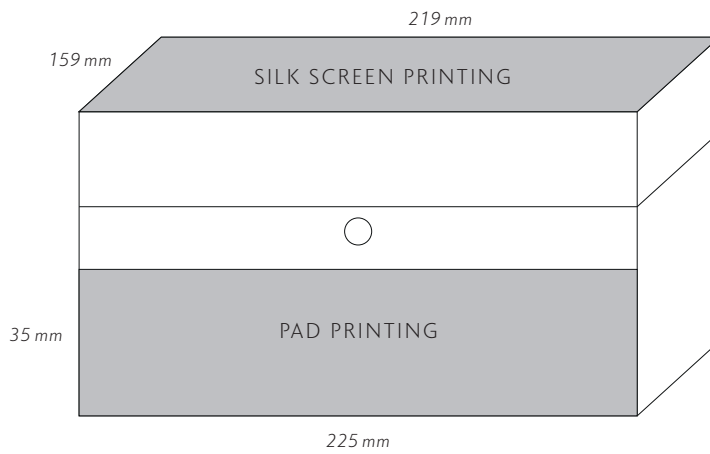

SIZE M

To meet the needs of our partners and their customers, Caran d'Ache provides easily identifiable packaging for each of our writing instruments with a consistent choice of colours, optimal sizes and designs...



LUXURY CASE 100010.963

Hot stamping (1 colour), Dim: 130x25 mm



ORIGINAL SLIM PACK BLACK 100014.130

For Alchemix
Pad printing (1 colour), Dim: 15x80 mm



ORIGINAL SLIM PACK GREY 100011.711

WHITE 100013.820

For 849
Pad printing (1 colour), Dim: 15x80 mm



CASE FOR 1 OR 2 PENS

CARAN D'ACHE LOGO 100004.064

WITHOUT CARAN D'ACHE LOGO 100005.496

Pad printing (2 colours), Dim: 50x20 mm



CASE FOR 1 PEN 100010.106

For 844 and 849

Silk screen printing (1 colour), Dim: 60x20 mm



CASE FOR 1 PEN 100010.105

888 Infinite



CARDBOARD CASE

For 844 or 849 (100008.715)

For 888 Infinite or Fixpencil (100009.468)

Hot stamping (1 colour), Dim: 80x10 mm



CASE FOR TWO PENCILS BLACK 100001.901 /

WHITE 100005.539

Silk screen printing (4 colours), Dim: 150x12 mm

Pad printing (2 colours), Dim: 80x10 mm

SERVICES NON-CUSTOMISABLE PACKAGING



CASE 100009.453

849 / 844

888 Infinite

Fixpencil



CASE 100010.957

849 / 844

888 Infinite

Fixpencil

Alchemix

Ecridor



CASE FOR ALCHEMIX 100013.327



CARDBOARD CASE 100008.495

849 / 844

CORPORATE GIFTS

The name itself represents a prestigious, educational world and has become a synonym for excellence and creativity. More than a simply brand, the Swiss company has imposed its own style: a "Maison de Haute Ecriture". With more than 200 writing instruments for both top-of-the-range luxury market and for the office, Caran d'Ache can propose many personalized gifts which are sure to capture attention.

PERSONAL ENGRAVING

Many Caran d'Ache writing instruments can be engraved on request to one of the brand's authorised retailers. The company's craftsmen are careful to create a space reserved for personalised engraving on the side opposite the clip. Here the customer can be very imaginative: a name, a date, or a message makes the writing instrument a highly personal object, unique and unmistakable.

INTERNATIONAL GUARANTEE

Lovers of handwriting often develop a real attachment to their pens. For this reason, our after-sales technicians do their very best to repair them whenever possible, only replacing them as a last resort. Repairs under guarantee are free of charge and other repairs are only carried out after the client has accepted a cost estimate. Caran d'Ache writing instruments are inspected and tested at each stage of production. When they leave the Geneva workshops they are in perfect condition and are guaranteed against any manufacturing defects. An international guarantee certificate accompanies each pen.



HOT STAMPING

Hot stamping is a technique that makes it possible to print colours in relief on all kinds of supports. A matrix in relief is heated to 100-200°C then a colour film is placed between it and the material to be printed. The pressure and the heat of the matrix transfer the graphic from the film onto the support.



LASER ENGRAVING

Laser engraving is a non-contact process. The marking is created by an intense light beam that fuses the material it touches. Mirrors guide the light beam precisely over the surface to be engraved.



DIAMOND ENGRAVING

Diamond engraving is performed using the point of a diamond cutter. It is used to personalise a pen, engraving the desired message with absolute precision and superb quality. This technique does not remove any material from the pen.

Script Filiaire Book Antiqua Helvetica Futura Roman Optima



SILKSCREEN PRINTING

Silk screen printing is similar to stencilling. A scraper is used to force ink through holes in a very fine screen onto the support material. The screen is a woven fabric in which some of the spaces between the thread links have been closed and others are left open to form the logo or the text to be printed. One screen is used for each colour.



PAD PRINTING

Pad printing is an indirect printing system used to mark many different types of material. A metal plate is engraved with acid, creating the design or message required. The cavities are filled with ink and a silicon pad is pressed onto the plate to pick up some of the ink then transfer it onto the object. This process delivers precise and rapid marking.

IMPRINT FACES

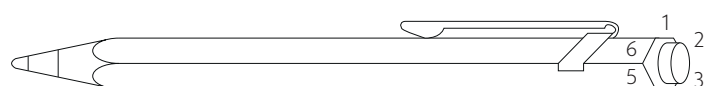

Face 1: position of the clip

TECHNICAL SHEET WOODEN GIFT BOX

You will be surprised to discover that this small box contains a wealth of artistic techniques. The three level beautiful artist's box is made from high quality polished wood which showcases the vast range of artistic possibilities provided by Caran d'Ache products. And especially how well they complement each other.

- Wooden gift box with golden silkscreen Caran d'Ache logo (inside + outside)
- High quality varnished birch wood
- Colour: Dark Mahogany
- Concealed hinges, golden locking system
- Dimensions: 29.1 x 22.4 x 4.2 cm
- Comes in its own cardboard box



30 SUPRACOLOR SOFT + 30 PABLO GIFT BOX / 3002.460

30 SUPRACOLOR SOFT watercolour pencils, with soft and watercolour lead with high covering power
30 PABLO water-resistant coloured pencils, smudge free permanent dry lead, high covering power



30 PRISMALO + 40 NEOCOLOR II GIFT BOX / 3002.470

30 PRISMALO watercolour pencils, with soft and resistant lead and high covering power. Recommended for detail work
40 NEOCOLOR II watercolour crayons, bright and opaque colours



40 NEOCOLOR II + 40 NEOCOLOR I GIFT BOX / 3002.480

40 NEOCOLOR II watercolour crayons, bright and opaque colours, suitable for different media
40 NEOCOLOR I non-soluble crayons, bright and opaque colours, suitable for different media
A selection of complementary colours with 10 metallic colours and 10 new Portrait colours from the NEOCOLOR I colour chart

MINIMUM QUANTITY

Standard: 10 pieces



ITEMS 3002. GIFT BOX Dim: 268 x 49 mm

Silk screen printing (1 colour)

They will remind adult artists of their first pencil boxes and encourage young artists to show all their imagination. These clever boxes, available in three versions, draw on all Caran d'Ache's expertise in colours to offer an easy, enjoyable introduction to artistic activities. They are ideal, original gifts that will delight artists of all ages with their quality and elegance.

- "Pencil case" box in wood with sliding transparent cover in plexiglass carrying the Caran d'Ache logo.
- Top-quality beech wood with protective varnish.
- Colour: dark mahogany
- Dimensions : 20.3 x 26.8 x 2.2 cm
- Supplied with transparent film protection



PENCIL CASE BOX WITH 30 SWISSCOLOR PENCILS / 285.430

30 SWISSCOLOR water-soluble colour pencils. Cedar wood. Strong yet soft leads Ø 2.8 mm. Brilliant colours, ideal for drawing and watercolours.



PENCIL CASE BOX WITH 24 FIBRALO FELT TIP PENS / 185.824

24 water-soluble felt tip pens. Medium point, large capacity (>600-meter line). Ideal for sketching, layouts, colouring and for teaching drawing.



PENCIL CASE BOX WITH MULTIPLE WATER-SOLUBLE PRODUCTS / 3000.424

12 SWISSCOLOR water-soluble pencils. 12 NEOCOLOR II water-soluble wax pastels, 2 trays of GOUACHE STUDIO (Yellow 010 and Red 070) and a no. 5 brush.

MINIMUM QUANTITY

Standard: 10 pieces

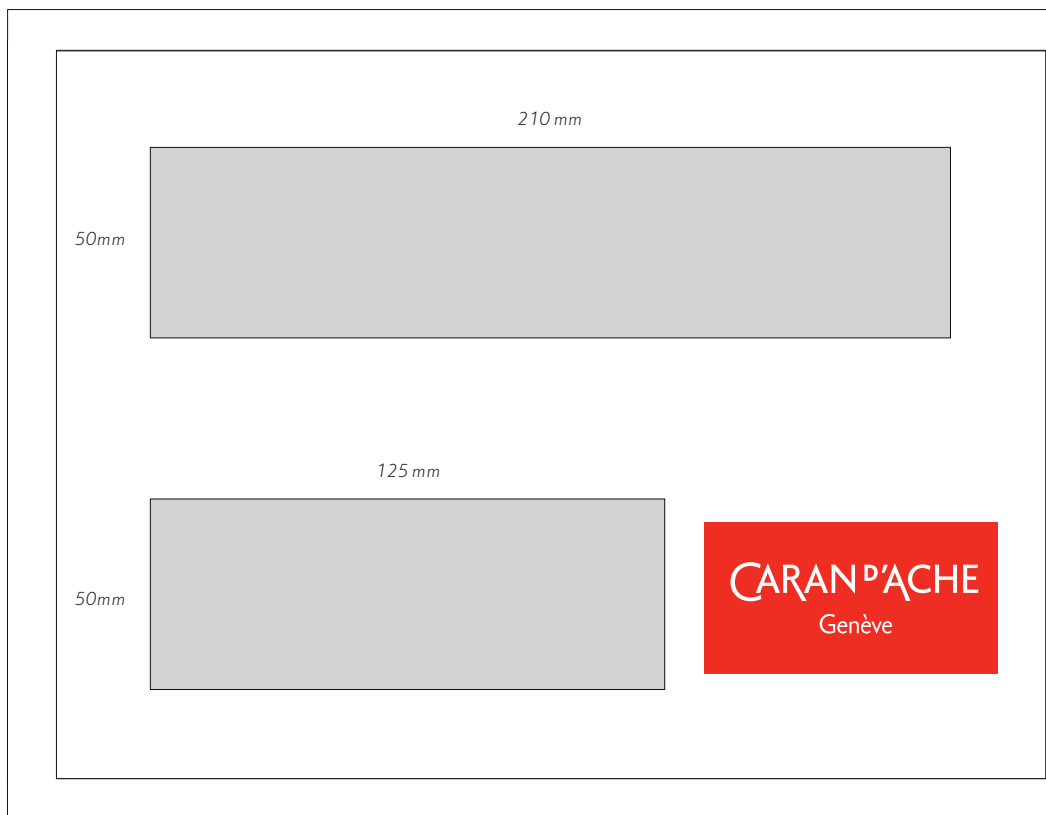

ITEMS 1285.430 / 185.824 / 3000.424

PLEXIGLASS Dim: 210 x 50 mm or 125 x 50 mm

Silk screen printing (1 colour)