

NARDI
YOUR OUTDOOR LIVING

listino prezzi price list 2019

IVA ESCLUSA - Prezzi validi dal 01 Ottobre 2018 VAT EXCLUDED - Prices valid from 1st October 2018

**listino prezzi
price list
2019**

LEGENDA / LEGEND

	impilabile / <i>stackable</i>
	impilabile orizzontalmente / <i>stackable horizontally</i>
	pieghevole / <i>folding</i>
	reclinabile / <i>reclining</i>
	tessuto sintetico / <i>synthetic fabric</i>
	tessuto / <i>fabric</i>
	allungabile / <i>extensible</i>
	sfoderabile / <i>removeable</i>
	prodotto da montare / <i>assembly required</i>
	cuscino disponibile su ordinazione / <i>cushion available to order</i>
	cuscini seduta e arredo/fit inclusi / <i>cushions Seduta and Arredo/Fit included</i>
	cuscino termoformato / <i>thermoformed cushion</i>
	dotato di rotelline / <i>with small wheels</i>
	dotato di piedini antiscivolo / <i>with non-slip feet</i>
	dotato di piedini regolabili / <i>adjustable height feet</i>
PP	polipropilene / <i>polypropylene</i>
PPF	polipropilene fiberglass / <i>polypropylene fiberglass</i>
AL-A	alluminio anodizzato / <i>anodized aluminium</i>
AL-V	alluminio verniciato / <i>coated aluminium</i>
V-T-S	vetro temperato serigrafato / <i>tempered screen-printed glass</i>
LAM	laminato HPL / <i>laminata HPL</i>
DT	durelTOP / <i>durelTOP</i>
IGN	ignifugo / <i>fireproof</i>
AL-ST	alluminio trattamento speciale per ambienti ad alto tasso salino/ <i>aluminium special treatment for high salinity environments</i>
W-R-S	tessuto Sunbrella idrorepellente/ <i>water-repellent Sunbrella fabric</i>
W-R	tessuto idrorepellente/ <i>water-repellent fabric</i>
POM-C	resina acetica/ <i>acetalic resin</i>
	peso del prodotto in chilogrammi / <i>weight of the model in kg</i>
	imballo con film - n. pezzi e volume in m ³ / <i>shrink-wrapped packing - number of pcs and volume in cbm</i>
	imballo cartonato - n. pezzi e volume in m ³ / <i>carton packing - number of pcs and volume in cbm</i>
	n. pezzi su pallet / <i>number of pcs on pallet</i>
	prodotto adatto all'utilizzo in esterno / <i>product suitable for outdoor use</i>
CATAS	prodotto certificato Catas / <i>product certified by Catas</i>
TESTED	prodotto testato a norma / <i>product tested</i>

INDICE / INDEX

KOMODO DIVANO MODULARE / komodo modular sofa	5
SEDUTE IN POLIPROPILENE / polypropylene seats	15
SEDUTE IN POLIPROPILENE E ALLUMINIO / polypropylene and aluminium seats	25
LETTINI / sunloungers	29
TAVOLI IN POLIPROPILENE / polypropylene tables	35
TAVOLI IN POLIPROPILENE E ALLUMINIO / polypropylene and aluminium tables	41
TAVOLI IN VETRO E ALLUMINIO / glass and aluminium tables	47
TAVOLI POLO / polo tables	51
BASI IN ALLUMINIO / aluminium bases	57
PIANI / tops	65
CUSCINI E ACCESSORI / cushions and accessories	75
MATERIALI / materials	81
CONDIZIONI GENERALI DI VENDITA / general terms of sale	91

KOMODO
DIVANO MODULARE

komodo
modular sofa

KOMODO 5 - divano modulare/modular sofa



modello
model

info
info

colore
colour

tessuto
fabric

ref.
ref.

€
€

KOMODO 5 NEW

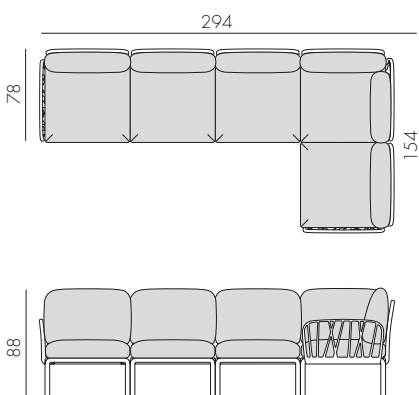

41,1

1
0,408 m³

15 pz



BIANCO

BIANCO

BIANCO

BIANCO

ANTRACITE

ANTRACITE

ANTRACITE

ANTRACITE

TORTORA

TORTORA

TORTORA

TORTORA

rosa quarzo

grigio

canvas Sunbrella®

adriatic Sunbrella®

rosa quarzo

grigio

canvas Sunbrella®

adriatic Sunbrella®

rosa quarzo

grigio

canvas Sunbrella®

adriatic Sunbrella®

40370.00.066

40370.00.163

40370.00.141

40370.00.142

40370.02.066

40370.02.163

40370.02.141

40370.02.142

40370.10.066

40370.10.163

40370.10.141

40370.10.142

€ 1800,00

€ 1800,00

€ 2200,00

€ 2200,00

€ 1800,00

€ 1800,00

€ 2200,00

€ 2200,00

€ 1800,00

€ 1800,00

€ 2200,00

€ 2200,00

SOLUTIONS

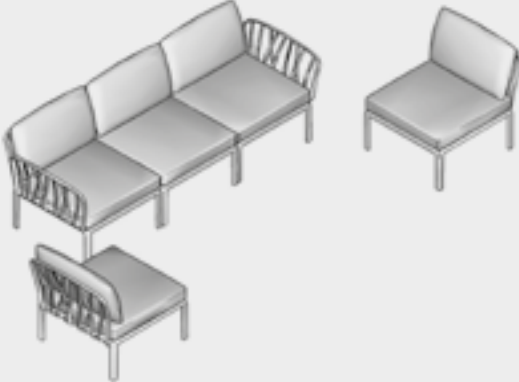
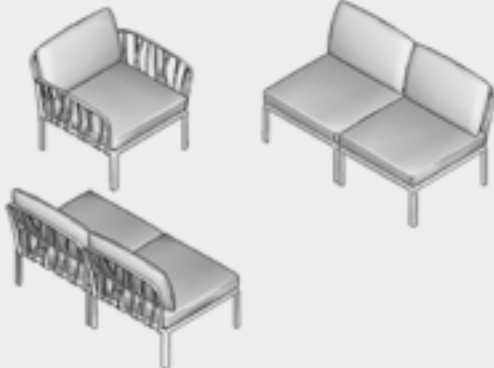
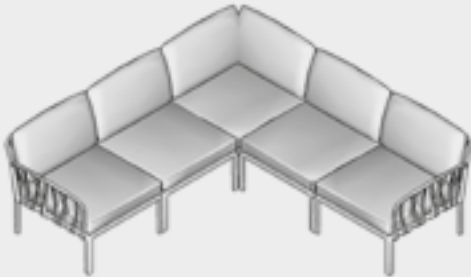
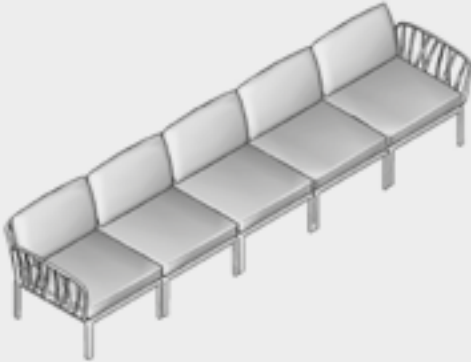
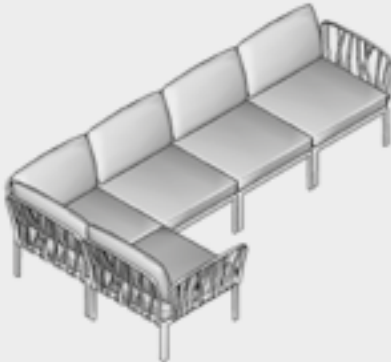
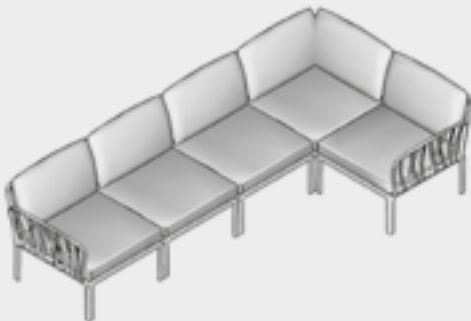

CONFIGURA E ORDINA IL TUO KOMODO

Configure and order your KOMODO

KOMODO è un divano modulare configurabile a piacere. Le sedute possono essere fissate tra loro e gli schienali e i braccioli sono agganciabili su tutti i lati.

Oltre alla versione standard KOMODO 5, è possibile configurare e ordinare la tua versione di KOMODO elencando tutti i singoli componenti che lo formano.

KOMODO is a modular sofa which can be configured to suit your particular needs. The seats can be secured to one another and the seat backs and armrests can be attached on all sides.

In addition to the standard KOMODO 5 version, you can configure and order your own version of KOMODO simply by listing all the individual components you require.

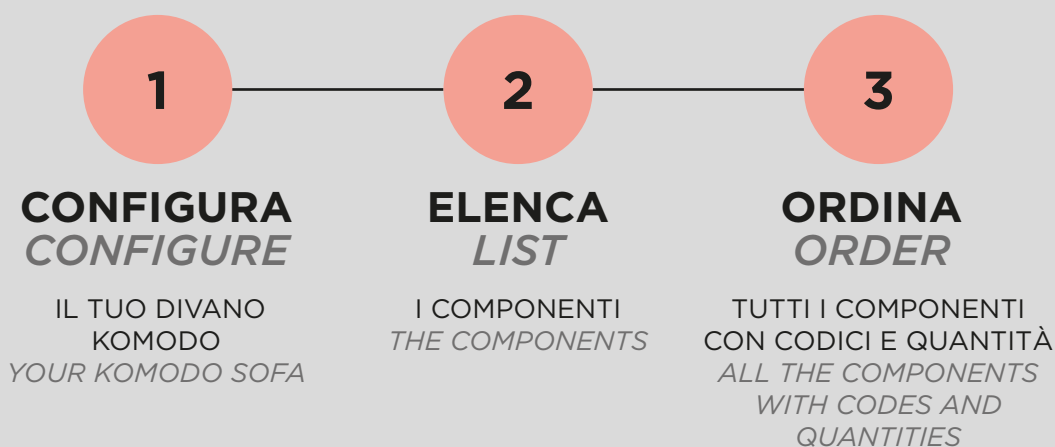







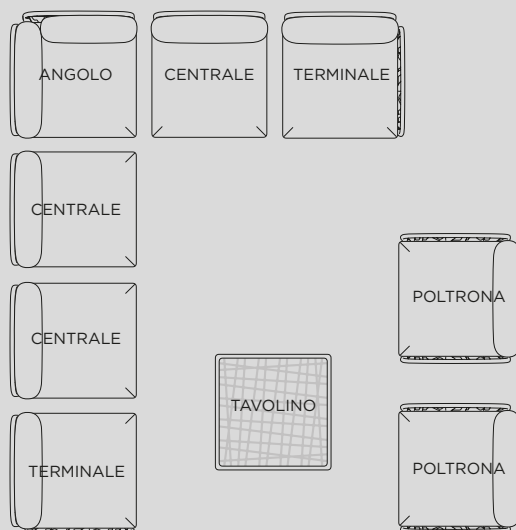





ESEMPIO DI ORDINE / ORDER EXAMPLE

- 1** **CONFIGURA** IL TUO DIVANO CON GLI ELEMENTI PRECOMPOSTI:
TERMINALE - CENTRALE - ANGOLO -
POUF - POLTRONA

CONFIGURE YOUR SOFA WITH THE
DEFAULT ELEMENTS:
END UNIT - CENTRAL UNIT - CORNER
UNIT - POUF - ARMCHAIR

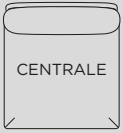

2 ELENCA E SOMMA I COMPONENTI CHE FORMANO GLI ELEMENTI PRECOMPOSTI
LIST AND ADD UP THE COMPONENTS MAKING UP THE DEFAULT ELEMENTS

	COMPONENTI COMPONENTS	KOMODO SEDUTA	KOMODO SCHIENALE	KOMODO BRACCIOLO	CUSCINO SEDUTA KOMODO	CUSCINO SCHIENALE KOMODO	CUSCINO SCHIENALE ANGOLO KOMODO	KOMODO TAVOLINO
	ELEMENTI PRECOMPOSTI DEFAULT ELEMENTS							
n.2	 TERMINALE	1+1	1+1	1+1	1+1	1+1		
n.3	 CENTRALE	1+1+1	1+1+1		1+1+1	1+1+1		
n.1	 ANGOLO	1	2		1	1	1	
n.2	 POLTRONA	1+1	1+1	2+2	1+1	1+1		
n.1	 TAVOLINO							1
	TOT	8	9	6	8	8	1	1

3 ORDINA TUTTI I COMPONENTI CON CODICI E QUANTITÀ
ORDER ALL THE COMPONENTS WITH CODES AND QUANTITIES

n. 8 KOMODO SEDUTA ref. 40XXX.XX.XXX

n. 9 KOMODO SCHIENALE ref. 40XXX.XX.XXX

n. 6 KOMODO BRACCIOLO ref. 40XXX.XX.XXX

n. 8 CUSCINO SEDUTA KOMODO ref. 36XXX.XX.XXX

n. 8 CUSCINO SCHIENALE KOMODO ref. 36XXX.XX.XXX

n. 1 CUSCINO SCHIENALE ANGOLO KOMODO ref. 36XXX.XX.XXX

n. 1 KOMODO TAVOLINO ref. 40XXX.XX.XXX

KOMODO ELEMENTI PRECOMPOSTI/DEFAULT ELEMENTS

modello model	componenti components	colore colour	fessuto fabric	€
KOMODO ELEMENTO TERMINALE DX/SX				
	<ul style="list-style-type: none"> 1 KOMODO SEDUTA 1 KOMODO SCHIENALE 1 KOMODO BRACCIOLO 1 CUSCINO SEDUTA KOMODO 1 CUSCINO SCHIENALE KOMODO 	<ul style="list-style-type: none"> BIANCO ANTRACITE TORTORA 	<ul style="list-style-type: none"> rosa quarzo € 425,00 grigio € 425,00 canvas Sunbrella® € 509,00 adriatic Sunbrella® € 509,00 	
KOMODO ELEMENTO CENTRALE				
	<ul style="list-style-type: none"> 1 KOMODO SEDUTA 1 KOMODO SCHIENALE 1 CUSCINO SEDUTA KOMODO 1 CUSCINO SCHIENALE KOMODO 	<ul style="list-style-type: none"> BIANCO ANTRACITE TORTORA 	<ul style="list-style-type: none"> rosa quarzo € 376,00 grigio € 376,00 canvas Sunbrella® € 460,00 adriatic Sunbrella® € 460,00 	
KOMODO ELEMENTO ANGOLO				
	<ul style="list-style-type: none"> 1 KOMODO SEDUTA 2 KOMODO SCHIENALE 1 CUSCINO SEDUTA KOMODO 1 CUSCINO SCHIENALE 1 CUSCINO SCHIENALE ANGOLO KOMODO 	<ul style="list-style-type: none"> BIANCO ANTRACITE TORTORA 	<ul style="list-style-type: none"> rosa quarzo € 511,00 grigio € 511,00 canvas Sunbrella® € 623,00 adriatic Sunbrella® € 623,00 	
KOMODO POUF				
	<ul style="list-style-type: none"> 1 KOMODO SEDUTA 1 CUSCINO SEDUTA KOMODO 	<ul style="list-style-type: none"> BIANCO ANTRACITE TORTORA 	<ul style="list-style-type: none"> rosa quarzo € 238,00 grigio € 238,00 canvas Sunbrella® € 288,00 adriatic Sunbrella® € 288,00 	

KOMODO ELEMENTI PRECOMPOSTI/DEFAULT ELEMENTS

modello model	componenti components	colore colour	tessuto fabric	€ €
KOMODO POLTRONA				
	<ul style="list-style-type: none"> 1 KOMODO SEDUTA 1 KOMODO SCHIENALE 2 KOMODO BRACCIOLO 1 CUSCINO SEDUTA KOMODO 1 CUSCINO SCHIENALE KOMODO 	<ul style="list-style-type: none"> BIANCO ANTRACITE TORTORA 	<ul style="list-style-type: none"> rosa quarzo grigio canvas Sunbrella® adriatic Sunbrella® 	<ul style="list-style-type: none"> € 474,00 € 474,00 € 558,00 € 558,00
KOMODO 2 POSTI				
	<ul style="list-style-type: none"> 2 KOMODO SEDUTA 2 KOMODO SCHIENALE 2 KOMODO BRACCIOLO 2 CUSCINO SEDUTA KOMODO 2 CUSCINO SCHIENALE KOMODO 	<ul style="list-style-type: none"> BIANCO ANTRACITE TORTORA 	<ul style="list-style-type: none"> rosa quarzo grigio canvas Sunbrella® adriatic Sunbrella® 	<ul style="list-style-type: none"> € 850,00 € 850,00 € 1018,00 € 1018,00
KOMODO 3 POSTI				
	<ul style="list-style-type: none"> 3 KOMODO SEDUTA 3 KOMODO SCHIENALE 2 KOMODO BRACCIOLO 3 CUSCINO SEDUTA KOMODO 3 CUSCINO SCHIENALE KOMODO 	<ul style="list-style-type: none"> BIANCO ANTRACITE TORTORA 	<ul style="list-style-type: none"> rosa quarzo grigio canvas Sunbrella® adriatic Sunbrella® 	<ul style="list-style-type: none"> € 1226,00 € 1226,00 € 1478,00 € 1478,00

KOMODO COMPONENTI/COMPONENTS

modello model	info info	colore colour	ref. ref.	€
KOMODO BRACCIOLO NEW				
		 BIANCO	40375.00.000	€ 49,00
		 ANTRACITE	40375.02.000	
		 TORTORA	40375.10.000	
KOMODO SCHIENALE NEW				
		 BIANCO	40376.00.000	€ 49,00
		 ANTRACITE	40376.02.000	
		 TORTORA	40376.10.000	
KOMODO SEDUTA NEW				
		 BIANCO	40377.00.000	€ 89,00
		 ANTRACITE	40377.02.000	
		 TORTORA	40377.10.000	
KOMODO TAVOLINO NEW				
		 BIANCO	40378.00.000	€ 130,00
		 ANTRACITE	40378.02.000	
		 TORTORA	40378.10.000	
KOMODO WALL NEW				
		 BIANCO	40379.00.000	€ 178,00
		 ANTRACITE	40379.02.000	
		 TORTORA	40379.10.000	

KOMODO COMPONENTI/COMPONENTS

modello
model

info
info

tessuto
fabric

ref.
ref.

€
€

CUSCINO SCHIENALE KOMODO **NEW**

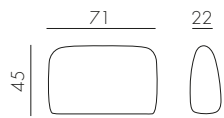

1,3



rosa quarzo

36370.52.066

€ 89,00



1
0,075 m³



grigio

36370.52.163

€ 89,00



25 pz



canvas Sunbrella®

36370.52.141

€ 123,00



adriatic Sunbrella®

36370.52.142

€ 123,00

CUSCINO SCHIENALE ANGOLO KOMODO **NEW**

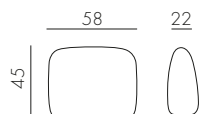

1,1



rosa quarzo

36370.54.066

€ 86,00



1
0,058 m³



grigio

36370.54.163

€ 86,00



35 pz



canvas Sunbrella®

36370.54.141

€ 114,00



adriatic Sunbrella®

36370.54.142

€ 114,00

CUSCINO SEDUTA KOMODO **NEW**

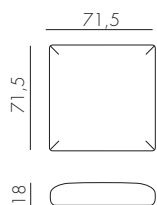

2,4



rosa quarzo

36370.60.066

€ 149,00



1
0,103 m³



grigio

36370.60.163

€ 149,00



24 pz



canvas Sunbrella®

36370.60.141

€ 199,00



adriatic Sunbrella®

36370.60.142

€ 199,00

SEDUTE IN
POLIPROPILENE

polypropylene seats

modello
model

info
info

colore
colour

ref.
ref.

€
€

TRILL ARMCHAIR NEW

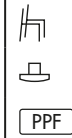
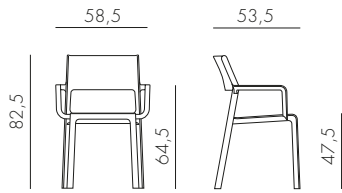

4,7
6
0,503 m³
24 pz
CADS

	BIANCO	40250.00.000
	ANTRACITE	40250.02.000
	TORTORA	40250.10.000
	AGAVE	40250.16.000
	OTTANIO	40250.49.000
	TABACCO	40250.53.000
	SENAPE	40250.56.000

€76,00

TRILL BISTROT NEW

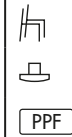
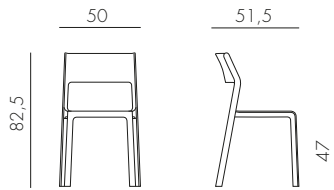

4,2
6
0,384 m³
24 pz
CADS

	BIANCO	40253.00.000
	ANTRACITE	40253.02.000
	TORTORA	40253.10.000
	AGAVE	40253.16.000
	OTTANIO	40253.49.000
	TABACCO	40253.53.000
	SENAPE	40253.56.000

€69,00

TRILL STOOL NEW

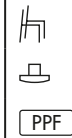
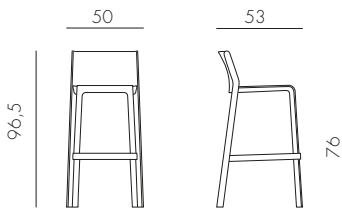

5,1
4
0,375 m³
32 pz
CADS

	BIANCO	40350.00.000
	ANTRACITE	40350.02.000
	TORTORA	40350.10.000
	AGAVE	40350.16.000
	OTTANIO	40350.49.000
	TABACCO	40350.53.000
	SENAPE	40350.56.000

€81,00

TRILL STOOL MINI NEW

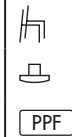
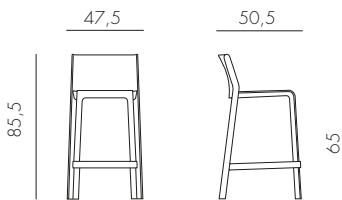

4,8
4
0,338 m³
32 pz
CADS

	BIANCO	40353.00.000
	ANTRACITE	40353.02.000
	TORTORA	40353.10.000
	AGAVE	40353.16.000
	OTTANIO	40353.49.000
	TABACCO	40353.53.000
	SENAPE	40353.56.000

€81,00

modello
model

info
info

colore
colour

ref.
ref.

€
€

NET BENCH

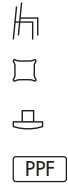
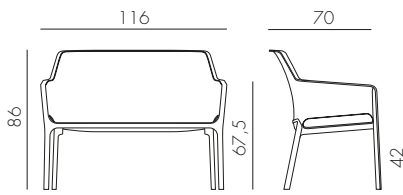

Kg 8,9
F 20
3,142 m³
20 pz
 PPF
CAVAS

BIANCO	40338.00.000
ANTRACITE	40338.02.000
SALICE	40338.04.000
TORTORA	40338.10.000
SENAPE	40338.56.000
CORALLO	40338.75.000

€ 170,00

NET RELAX

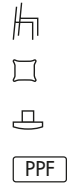
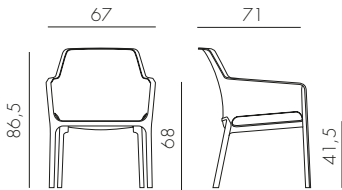

Kg 4,7
F 20
1,921 m³
20 pz
 PPF
CAVAS

BIANCO	40327.00.000
ANTRACITE	40327.02.000
SALICE	40327.04.000
TORTORA	40327.10.000
SENAPE	40327.56.000
CORALLO	40327.75.000

€ 99,00

NET

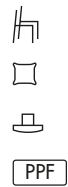
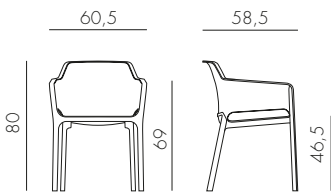

Kg 3,9
F 22
1,455 m³
22 pz
 PPF
CAVAS

BIANCO	40326.00.000
ANTRACITE	40326.02.000
SALICE	40326.04.000
TORTORA	40326.10.000
SENAPE	40326.56.000
CORALLO	40326.75.000

€ 84,00

BIT

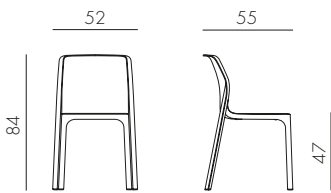

Kg 3,5
F 24
1,499 m³
24 pz
 PPF
TESTED

BIANCO	40328.00.000
ANTRACITE	40328.02.000
SALICE	40328.04.000
TORTORA	40328.10.000
SENAPE	40328.56.000
CORALLO	40328.75.000

€ 72,00

modello
model

info
info

colore
colour

ref.
ref.

€

BORA

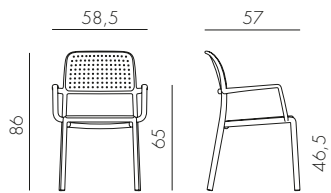

PPF



4,4



24
1,522 m³



24 pz



CADIS



BIANCO

40242.00.000



ANTRACITE

40242.02.000



CAFFÈ

40242.05.000



ROSSO

40242.07.000



TORTORA

40242.10.000



CELESTE

40242.39.000

€ 64,00

BORA BISTROT

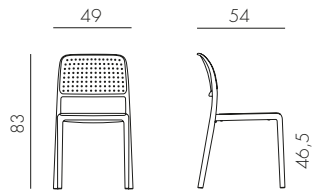

PPF



3,7



24
1,438 m³



24 pz



CADIS



BIANCO

40243.00.000



ANTRACITE

40243.02.000



CAFFÈ

40243.05.000



ROSSO

40243.07.000



TORTORA

40243.10.000



CELESTE

40243.39.000

€ 57,00

RIVA

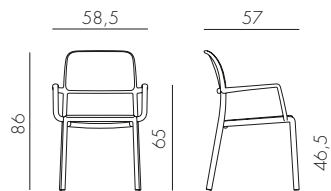

PPF



4,6



24
1,522 m³



24 pz



CADIS



BIANCO

40246.00.000



ANTRACITE

40246.02.000



CAFFÈ

40246.05.000



ROSSO

40246.07.000



TORTORA

40246.10.000



CELESTE

40246.39.000

€ 68,00

RIVA BISTROT

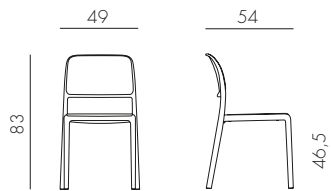

PPF



4



24
1,438 m³



24 pz



CADIS



BIANCO

40247.00.000



ANTRACITE

40247.02.000



CAFFÈ

40247.05.000



ROSSO

40247.07.000



TORTORA

40247.10.000



CELESTE

40247.39.000

€ 61,00

modello
model

info
info

colore
colour

ref.
ref.

€
€

COSTA

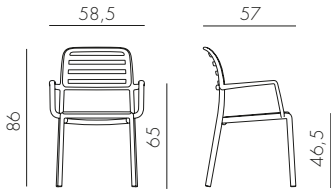

PPF



4,5



24
1,522 m³



24 pz



CADIS

BIANCO

40244.00.000

ANTRACITE

40244.02.000

CAFFÈ

40244.05.000

ROSSO

40244.07.000

TORTORA

40244.10.000

CELESTE

40244.39.000

€ 64,00

COSTA BISTROT

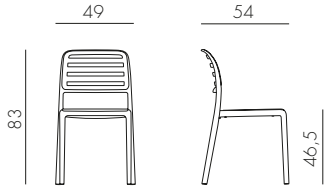

PPF



3,9



24
1,438 m³



24 pz



CADIS

BIANCO

40245.00.000

ANTRACITE

40245.02.000

CAFFÈ

40245.05.000

ROSSO

40245.07.000

TORTORA

40245.10.000

CELESTE

40245.39.000

€ 57,00

ACQUAMARINA

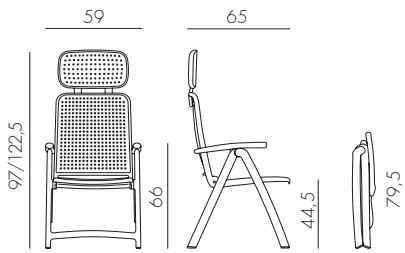

PPF



8



1
0,086 m³



26 pz



CADIS

BIANCO

40314.00.000

ANTRACITE

40314.02.000

CAFFÈ

40314.05.000

TORTORA

40314.10.000

CELESTE

40314.39.000

€ 110,50

DARSENÀ

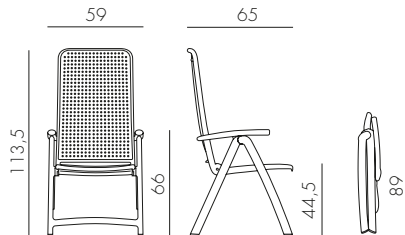

PPF



7,7



1
0,085 m³



28 pz



CADIS

BIANCO

40316.00.000

ANTRACITE

40316.02.000

CAFFÈ

40316.05.000

TORTORA

40316.10.000

CELESTE

40316.39.000

€ 97,00

modello
model

info
info

colore
colour

ref.
ref.

€

LIDO

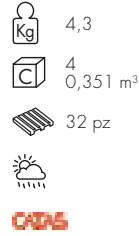
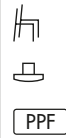
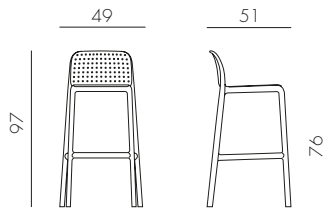

	BIANCO	40344.00.000
	ANTRACITE	40344.02.000
	CAFFÈ	40344.05.000
	ROSSO	40344.07.000
	TORTORA	40344.10.000
	CELESTE	40344.39.000

€76,00

LIDO MINI

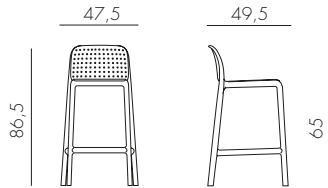

	BIANCO	40345.00.000
	ANTRACITE	40345.02.000
	CAFFÈ	40345.05.000
	ROSSO	40345.07.000
	TORTORA	40345.10.000
	CELESTE	40345.39.000

€76,00

FARO

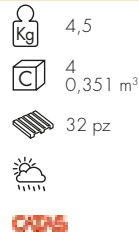
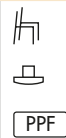
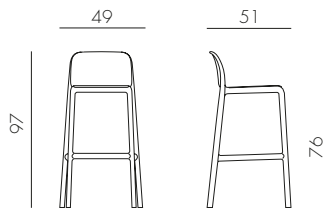

	BIANCO	40346.00.000
	ANTRACITE	40346.02.000
	CAFFÈ	40346.05.000
	ROSSO	40346.07.000
	TORTORA	40346.10.000
	CELESTE	40346.39.000

€76,00

FARO MINI

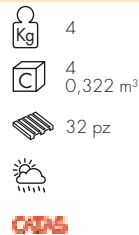
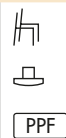
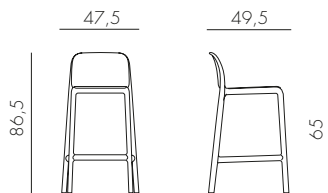

	BIANCO	40347.00.000
	ANTRACITE	40347.02.000
	CAFFÈ	40347.05.000
	ROSSO	40347.07.000
	TORTORA	40347.10.000
	CELESTE	40347.39.000

€76,00

modello model	info info	colore colour	ref. ref.	€ €					
PALMA									
				<table border="1"> <tr><td>40237.00.000</td></tr> <tr><td>40237.00.010</td></tr> <tr><td>40237.02.002</td></tr> <tr><td>40237.05.005</td></tr> <tr><td>40237.10.010</td></tr> </table>	40237.00.000	40237.00.010	40237.02.002	40237.05.005	40237.10.010
40237.00.000									
40237.00.010									
40237.02.002									
40237.05.005									
40237.10.010									
				€ 68,50					
ERICA									
				<table border="1"> <tr><td>40236.00.000</td></tr> <tr><td>40236.00.010</td></tr> <tr><td>40236.02.002</td></tr> <tr><td>40236.05.005</td></tr> <tr><td>40236.10.010</td></tr> </table>	40236.00.000	40236.00.010	40236.02.002	40236.05.005	40236.10.010
40236.00.000									
40236.00.010									
40236.02.002									
40236.05.005									
40236.10.010									
				€ 63,50					
GARDENIA									
				<table border="1"> <tr><td>40238.00.000</td></tr> <tr><td>40238.00.010</td></tr> <tr><td>40238.02.002</td></tr> <tr><td>40238.05.005</td></tr> <tr><td>40238.10.010</td></tr> </table>	40238.00.000	40238.00.010	40238.02.002	40238.05.005	40238.10.010
40238.00.000									
40238.00.010									
40238.02.002									
40238.05.005									
40238.10.010									
				€ 68,50					
DALIA									
				<table border="1"> <tr><td>40239.00.000</td></tr> <tr><td>40239.00.010</td></tr> <tr><td>40239.02.002</td></tr> <tr><td>40239.05.005</td></tr> <tr><td>40239.10.010</td></tr> </table>	40239.00.000	40239.00.010	40239.02.002	40239.05.005	40239.10.010
40239.00.000									
40239.00.010									
40239.02.002									
40239.05.005									
40239.10.010									
				€ 63,50					
ZAC CLASSIC									
				<table border="1"> <tr><td>40324.00.000</td></tr> <tr><td>40324.03.000</td></tr> <tr><td>40324.10.000</td></tr> <tr><td>40324.12.000</td></tr> </table>	40324.00.000	40324.03.000	40324.10.000	40324.12.000	
40324.00.000									
40324.03.000									
40324.10.000									
40324.12.000									
				€ 57,00					
ZAC SPRING									
				<table border="1"> <tr><td>40325.00.000</td></tr> <tr><td>40325.02.000</td></tr> <tr><td>40325.07.000</td></tr> <tr><td>40325.12.000</td></tr> </table>	40325.00.000	40325.02.000	40325.07.000	40325.12.000	
40325.00.000									
40325.02.000									
40325.07.000									
40325.12.000									
				€ 57,00					

modello
model

info
info

colore
colour

tessuto
fabric

ref.
ref.

€
€

ARIA (ARIA POLTRONA + CUSCINO SEDUTA + CUSCINO ARREDO)

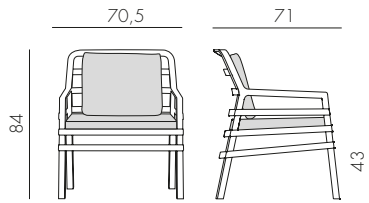

7,9



1
0,261 m³



8 pz



CADIS



	BIANCO		lime *	40330.00.061.061	€ 179,00
	BIANCO		cherry	40330.00.065.065	
	BIANCO		melanzana	40330.00.068.068	
	BIANCO		bianco *	40330.00.155.155	€ 239,00
	BIANCO		caffè	40330.00.165.165	
	BIANCO		grigio *	40330.00.163.163	
	BIANCO		grigio Sunbrella®	40330.00.136.136	€ 239,00
	ANTRACITE		lime	40330.02.061.061	€ 179,00
	ANTRACITE		cherry	40330.02.065.065	
	ANTRACITE		melanzana	40330.02.068.068	
	ANTRACITE		bianco	40330.02.155.155	€ 239,00
	ANTRACITE		caffè *	40330.02.165.165	
	ANTRACITE		grigio *	40330.02.163.163	
	ANTRACITE		grigio Sunbrella®	40330.02.136.136	€ 239,00
	CAFFÈ		lime	40330.05.061.061	€ 179,00
	CAFFÈ		cherry	40330.05.065.065	
	CAFFÈ		melanzana	40330.05.068.068	
	CAFFÈ		bianco	40330.05.155.155	€ 239,00
	CAFFÈ		caffè *	40330.05.165.165	
	CAFFÈ		grigio	40330.05.163.163	
	CAFFÈ		grigio Sunbrella®	40330.05.136.136	€ 239,00
	TORTORA		lime	40330.10.061.061	€ 179,00
	TORTORA		cherry	40330.10.065.065	
	TORTORA		melanzana	40330.10.068.068	
	TORTORA		bianco *	40330.10.155.155	€ 239,00
	TORTORA		caffè *	40330.10.165.165	
	TORTORA		grigio *	40330.10.163.163	
	TORTORA		grigio Sunbrella®	40330.10.136.136	€ 239,00

* Disponibile a magazzino. Le altre versioni su ordinazione
Available ex-stock. Other versions available on order

modello
model

info
info

colore
colour

tessuto
fabric

ref.
ref.

€
€

ARIA FIT (ARIA POLTRONA + CUSCINO SEDUTA + CUSCINO FIT)

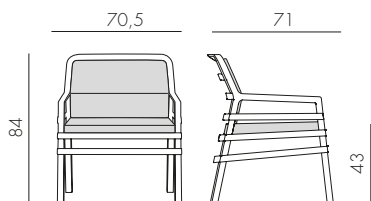

Kg 7,9
C 1
0,261 m³
8 pz
 CASA

colore	tessuto	ref.	€
BIANCO	bianco	40330.00.155.FIT	€ 228,00
BIANCO	caffè	40330.00.165.FIT	
BIANCO	grigio	40330.00.163.FIT	
BIANCO	grigio Sunbrella®	40330.00.136.FIT	€ 295,00
ANTRACITE	bianco	40330.02.155.FIT	€ 228,00
ANTRACITE	caffè	40330.02.165.FIT	
ANTRACITE	grigio	40330.02.163.FIT	
ANTRACITE	grigio Sunbrella®	40330.02.136.FIT	€ 295,00
CAFFÈ	bianco	40330.05.155.FIT	€ 228,00
CAFFÈ	caffè	40330.05.165.FIT	
CAFFÈ	grigio	40330.05.163.FIT	
CAFFÈ	grigio Sunbrella®	40330.05.136.FIT	€ 295,00
TORTORA	bianco	40330.10.155.FIT	€ 228,00
TORTORA	caffè	40330.10.165.FIT	
TORTORA	grigio	40330.10.163.FIT	
TORTORA	grigio Sunbrella®	40330.10.136.FIT	€ 295,00

* Disponibile a magazzino. Le altre versioni su ordinazione
Available ex-stock. Other versions available on order

SEDUTE IN
POLIPROPILENE
E ALLUMINIO

polypropylene and
aluminium seats

modello
model

info
info

colore
colour

gambe in alluminio
aluminium legs

ref.
ref.

€
€

NINFEA DINNER

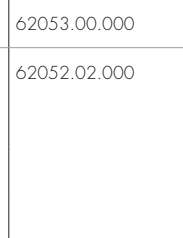
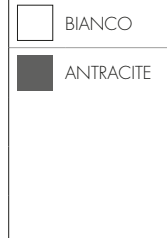
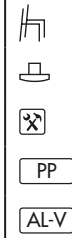
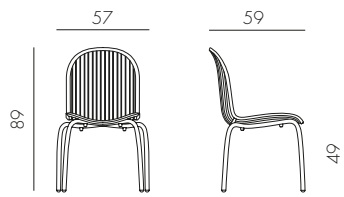

€ 92,00

NINFEA RELAX

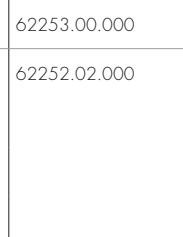
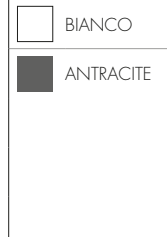
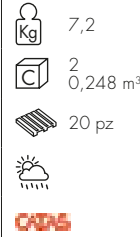
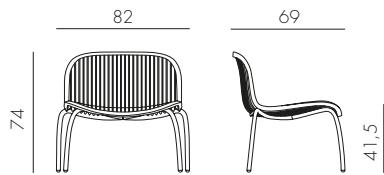

€ 128,00

DAMA

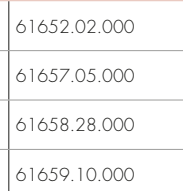
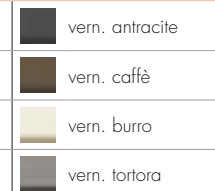
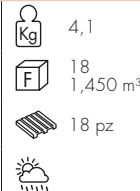
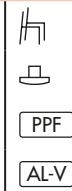
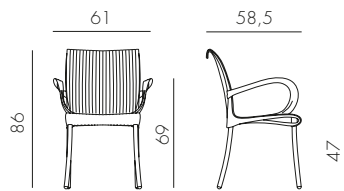

€ 65,00

REGINA

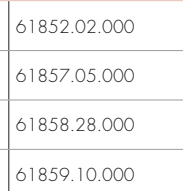
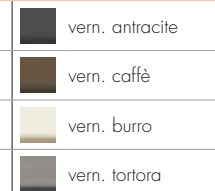
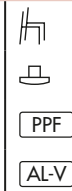
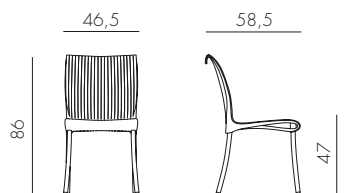

€ 61,00

DUCA

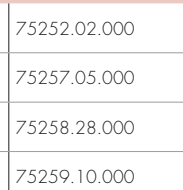
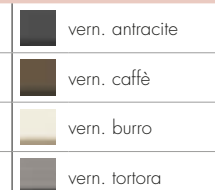
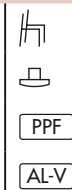
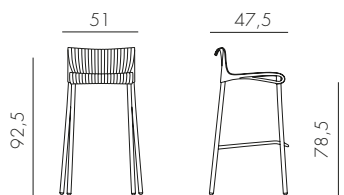

€ 116,00

modello
model

info
info

colore
colour

gambe in alluminio
aluminium legs

ref.
ref.

€
€

MUSA

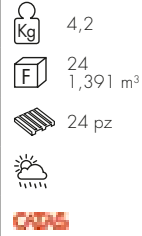
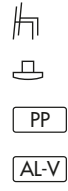
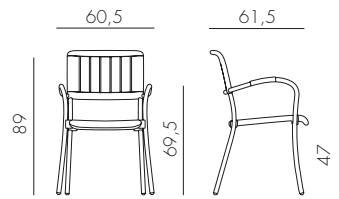

61053.00.000
61052.02.000
61057.05.000
61059.10.000

€ 89,50

ARTICA WICKER

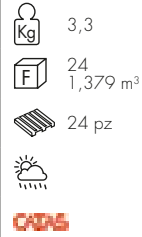
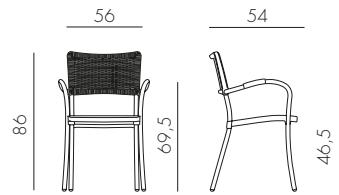

60150.02.000
60150.05.000
60152.02.000

€ 84,50

AURORA

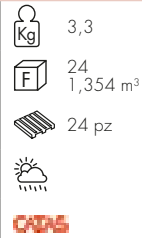
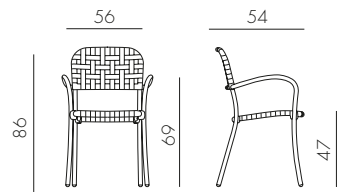

60250.00.000
60250.02.000
60250.05.000
60252.02.000

€ 84,50

LETTINI

sunloungers

sunloungers

modello
model

info
info

colore struttura
frame colour

tessuto sintetico
synthetic fabric

ref.
ref.

€
€

ATLANTICO

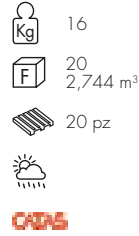
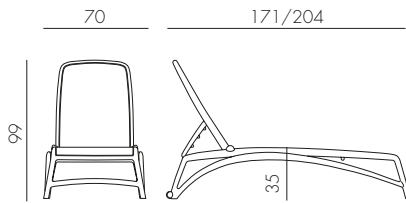

	BIANCO		rosa	40450.00.056
	BIANCO		celeste	40450.00.075
	BIANCO		mandarino	40450.00.083
	BIANCO		prato	40450.00.084
	BIANCO		blu	40450.00.102
	BIANCO		tortora	40450.00.104
	BIANCO		bianco	40450.00.107
	ANTRACITE		antracite	40450.02.057
	ANTRACITE		celeste	40450.02.075
	CAFFÈ		tortora	40450.05.104
	CAFFÈ		prato	40450.05.084
	CAFFÈ		celeste	40450.05.075
	TORTORA		celeste	40450.10.075
	TORTORA		tortora	40450.10.104
	TORTORA		bianco	40450.10.107

€ 262,00

BRACCIOLO ATLANTICO

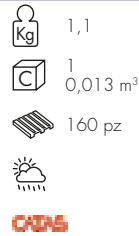
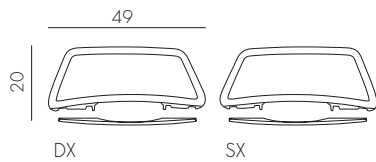

	BIANCO			40452.00.000
	ANTRACITE			40452.02.000
	CAFFÈ			40452.05.000
	TORTORA			40452.10.000

€ 24,00

modello
model

info
info

colore struttura
frame colour

tessuto sintetico
synthetic fabric

ref.
ref.

€
€

ALFA

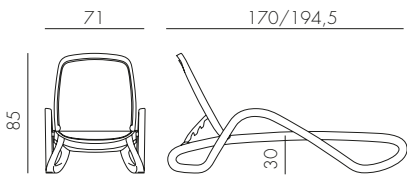

Kg 14
F 17
3,041 m³
17 pz

ODS

	BIANCO		bianco	40416.00.108
	BIANCO		blu	40416.00.112
	BIANCO		beige	40416.00.115
	BIANCO		tortora	40416.00.124
	BIANCO		trama beige	40416.00.078
	BIANCO		trama bianco	40416.00.121
	CAFFÈ		beige	40416.05.115
	TORTORA		tortora	40416.10.124
	ANTRACITE		trama beige	40416.02.078
	ANTRACITE		trama antrac.	40416.02.116
	CAFFÈ		trama beige	40416.05.078
	CAFFÈ		trama caffè	40416.05.117
	TORTORA		trama bianco	40416.10.121

€ 189,50

€ 199,00

€ 210,50

€ 220,00

OMEGA

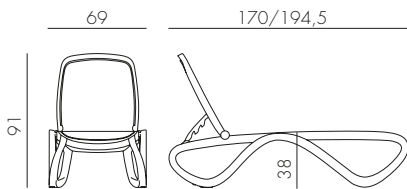

Kg 14,3
F 18
3,102 m³
18 pz

ODS

	BIANCO		bianco	40417.00.108
	BIANCO		blu	40417.00.112
	BIANCO		beige	40417.00.115
	BIANCO		tortora	40417.00.124
	BIANCO		trama beige	40417.00.078
	BIANCO		trama bianco	40417.00.121
	CAFFÈ		beige	40417.05.115
	TORTORA		tortora	40417.10.124
	ANTRACITE		trama beige	40417.02.078
	ANTRACITE		trama antrac.	40417.02.116
	CAFFÈ		trama beige	40417.05.078
	CAFFÈ		trama caffè	40417.05.117
	TORTORA		trama bianco	40417.10.121

€ 189,50

€ 199,00

€ 210,50

€ 220,00

modello model	info info	colore struttura frame colour	tessuto sintetico synthetic fabric	ref. ref.	€ €	
EDEN						
		14,7 17 3,041 m ³ 17 pz	<input type="checkbox"/> BIANCO	40414.00.000	€ 131,00	
			<input checked="" type="checkbox"/> TORTORA	40414.10.000	€ 144,00	
TROPICO						
		15,1 18 3,102 m ³ 18 pz	<input type="checkbox"/> BIANCO	40413.00.000	€ 131,00	
			<input checked="" type="checkbox"/> TORTORA	40413.10.000	€ 144,00	
PARASOLE (ALFA-OMEGA-EDEN-TROPICO)						
		1,4 1 0,015 m ³ 80 pz	<input type="checkbox"/> BIANCO	<input type="checkbox"/> bianco	40418.00.108	€ 42,50
			<input type="checkbox"/> BIANCO	<input checked="" type="checkbox"/> blu	40418.00.112	
			<input type="checkbox"/> BIANCO	<input type="checkbox"/> beige	40418.00.115	
			<input type="checkbox"/> BIANCO	<input type="checkbox"/> tortora	40418.00.124	€ 45,00
			<input type="checkbox"/> BIANCO	<input type="checkbox"/> trama beige	40418.00.078	
			<input type="checkbox"/> BIANCO	<input type="checkbox"/> trama bianco	40418.00.121	
			<input checked="" type="checkbox"/> CAFFÈ	<input type="checkbox"/> beige	40418.05.115	€ 46,00
			<input checked="" type="checkbox"/> TORTORA	<input type="checkbox"/> tortora	40418.10.124	
			<input checked="" type="checkbox"/> ANTRACITE	<input type="checkbox"/> trama beige	40418.02.078	
			<input checked="" type="checkbox"/> ANTRACITE	<input type="checkbox"/> trama antrac.	40418.02.116	€ 48,50
			<input checked="" type="checkbox"/> CAFFÈ	<input type="checkbox"/> trama beige	40418.05.078	
			<input checked="" type="checkbox"/> CAFFÈ	<input type="checkbox"/> trama caffè	40418.05.117	
<input checked="" type="checkbox"/> TORTORA	<input type="checkbox"/> trama bianco	40418.10.121				

modello
model

info
info

colore struttura
frame colour

tessuto sintetico
synthetic fabric

ref.
ref.

€
€

RICAMBIO ATLANTICO

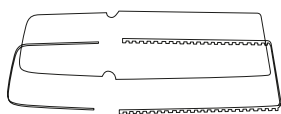

POM-C



1,3



1
0,046 m³



50 pz



CADIS

<input type="checkbox"/>	BIANCO		rosa	40460.00.056
<input type="checkbox"/>	BIANCO		celeste	40460.00.075
<input type="checkbox"/>	BIANCO		mandarino	40460.00.083
<input type="checkbox"/>	BIANCO		prato	40460.00.084
<input type="checkbox"/>	BIANCO		blu	40460.00.102
<input type="checkbox"/>	BIANCO		tortora	40460.00.104
<input type="checkbox"/>	BIANCO		bianco	40460.00.107
<input type="checkbox"/>	NERO		antracite	40460.01.057
<input type="checkbox"/>	NERO		celeste	40460.01.075
<input type="checkbox"/>	NERO		prato	40460.01.084
<input type="checkbox"/>	NERO		tortora	40460.01.104

€ 85,00

RICAMBIO ALFA-OMEGA

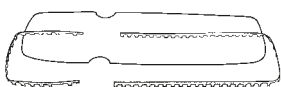

POM-C



1,6



1
0,046 m³



50 pz



CADIS

<input type="checkbox"/>	BIANCO		bianco	40424.00.108
<input type="checkbox"/>	BIANCO		beige	40424.01.115
<input type="checkbox"/>	BIANCO		tortora	40424.00.124
<input type="checkbox"/>	BIANCO		trama beige	40424.01.078
<input type="checkbox"/>	BIANCO		trama bianco	40424.00.121
<input type="checkbox"/>	NERO		blu	40424.00.112
<input type="checkbox"/>	NERO		tortora	40424.01.124
<input type="checkbox"/>	NERO		beige	40424.00.115
<input type="checkbox"/>	NERO		trama beige	40424.00.078
<input type="checkbox"/>	NERO		trama antrac.	40424.00.116
<input type="checkbox"/>	NERO		trama caffè	40424.00.117

€ 66,50

€ 79,00

€ 66,50

€ 79,00

STAMPA LOGO PERSONALIZZATO/PRINTING OF PERSONALIZED LOGO

Stampa LOGO a 1 colore sui lettini Alfa, Omega, Atlantico e sul parasole (NON POSSIBILE sul tessuto TRAMA)

Printing of 1 single colour LOGO on Alfa Omega Atlantico sunloungers and on sunshades (NOT possible on the TRAMA fabric)

Costo fisso per impianto/ Fixed cost for plant		€ 330,00
Quantità/Quantity		
da/from	a/to	
30 pz minimo/pcs minimum	100 pz/pcs	€ 8,30
101 pz/pcs	300 pz/pcs	€ 6,70
301 pz/pcs	1000 pz/pcs	€ 5,20
oltre/over 1000 pz/pcs		€ 4,20

TAVOLI IN
POLIPROPILENE

polypropylene tables

modello
model

info
info

colore
colour

ref.
ref.

€
€

CLIP 80

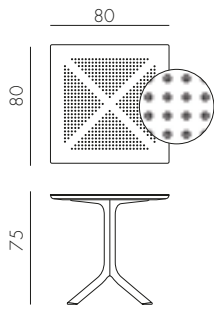

<input type="checkbox"/> BIANCO	40082.00.000
<input checked="" type="checkbox"/> ANTRACITE	40082.02.000
<input type="checkbox"/> TORTORA	40082.10.000

€ 169,00

CLIP 70

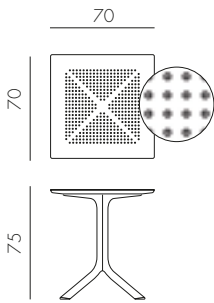

<input type="checkbox"/> BIANCO	40084.00.000
<input checked="" type="checkbox"/> ANTRACITE	40084.02.000
<input type="checkbox"/> TORTORA	40084.10.000

€ 159,00

CLIPX 80 NEW

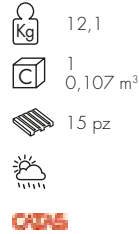
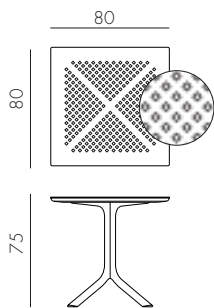

<input type="checkbox"/> BIANCO	40083.00.000
<input checked="" type="checkbox"/> ANTRACITE	40083.02.000
<input type="checkbox"/> TORTORA	40083.10.000

€ 169,00

CLIPX 70 NEW

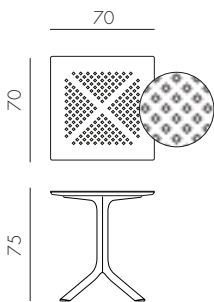

<input type="checkbox"/> BIANCO	40085.00.000
<input checked="" type="checkbox"/> ANTRACITE	40085.02.000
<input type="checkbox"/> TORTORA	40085.10.000

€ 159,00

modello
model

info
info

colore
colour

ref.
ref.

€
€

BASE CLIP **NEW**

Top ø80 - 70x70 - 80x80

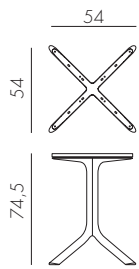

PPF



7,7



1
0,107 m³



15 pz



CATAS

BIANCO

40088.00.000

ANTRACITE

40088.02.000

TORTORA

40088.10.000

€ 94,00

STEP

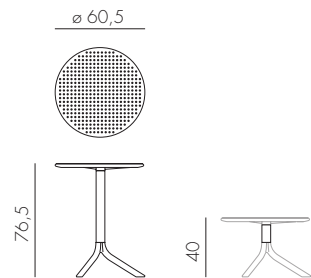

PPF



4,2



1
0,129 m³



24 pz



BIANCO

40056.00.000

ANTRACITE

40056.02.000

CAFFÈ

40056.05.000

ROSSO

40056.07.000

TORTORA

40056.10.000

CELESTE

40056.39.000

€ 69,00

SPRITZ

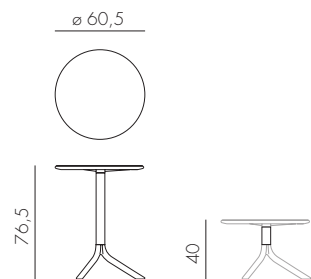

PPF



4,3



1
0,129 m³



24 pz



BIANCO

40058.00.000

ANTRACITE

40058.02.000

CAFFÈ

40058.05.000

ROSSO

40058.07.000

TORTORA

40058.10.000

CELESTE

40058.39.000

€ 69,00

modello
model

info
info

colore
colour

ref.
ref.

€
€

NET TABLE 100

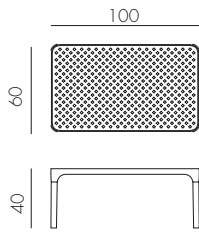

PPF



6,3



1
0,062 m³



44 pz



CADIS



BIANCO

40064.00.000



ANTRACITE

40064.02.000



SALICE

40064.04.000



TORTORA

40064.10.000



SENAPE

40064.56.000



CORALLO

40064.75.000

€ 90,00

ARIA TAVOLINO 100

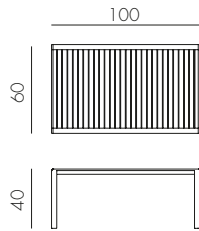

PP



8



1
0,072 m³



40 pz



CADIS



BIANCO

40052.00.000



ANTRACITE

40052.02.000



CAFFÈ

40052.05.000



TORTORA

40052.10.000

€ 87,00

ARIA TAVOLINO 60

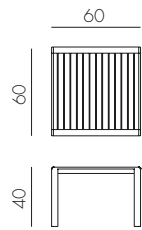

PP



5



1
0,047 m³



72 pz



CADIS



BIANCO

40051.00.000



ANTRACITE

40051.02.000



CAFFÈ

40051.05.000



TORTORA

40051.10.000

€ 66,00

modello
model

info
info

colore
colour

ref.
ref.

€
€

POP NEW

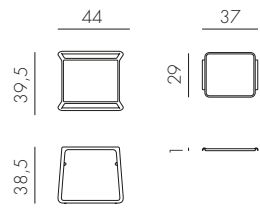

PPF



2,5



4
0,140 m³



48 pz



ODAS

BIANCO

40048.00.000

ANTRACITE

40048.02.000

CAFFÈ

40048.05.000

TORTORA

40048.10.000

€ 49,50

RODI

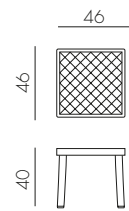

PP



2,3



7
0,103 m³



140 pz



ODAS

BIANCO

40050.00.000

ANTRACITE

40050.02.000

CAFFÈ

40050.05.000

TORTORA

40050.10.000

€ 24,50

€ 26,50

TAVOLI IN
POLIPROPILENE
E ALLUMINIO

polypropylene and
aluminium tables

modello model	info info	colore piano top colour	gambe in alluminio aluminium legs	ref. ref.	€ €
RIO 210 EXTENSIBLE					
			BIANCO vern. bianco	48253.00.000	€ 780,00
			ANTRACITE * vern. antracite	48252.02.000	
TORTORA vern. tortora	48259.10.000				
RIO 140 EXTENSIBLE					
			BIANCO vern. bianco	48353.00.000	€ 650,00
			ANTRACITE * vern. antracite	48352.02.000	
TORTORA vern. tortora	48359.10.000				
ALLORO 210 EXTENSIBLE					
			BIANCO vern. bianco	42853.00.000	€ 659,00
			TORTORA vern. bianco	42853.10.000	
ANTRACITE * vern. antracite	42852.02.000				
CAFFÈ * vern. caffè	42857.05.000				
TORTORA vern. tortora	42859.10.000				
ALLORO 140 EXTENSIBLE					
			BIANCO vern. bianco	42753.00.000	€ 528,50
			TORTORA vern. bianco	42753.10.000	
ANTRACITE * vern. antracite	42752.02.000				
CAFFÈ * vern. caffè	42757.05.000				
TORTORA vern. tortora	42759.10.000				

* Piani da utilizzare solo in zone ombreggiate
Only use table tops in shaded areas

modello
model

info
info

colore piano
top colour

gambe in alluminio
aluminium legs

ref.
ref.

€
€

LIBECCIO

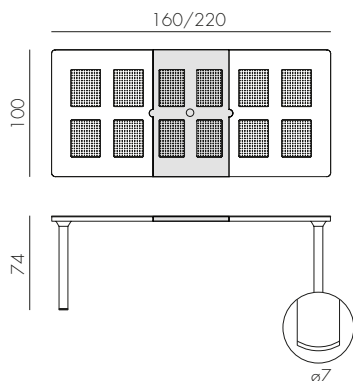

PP

DT

AL-V



28,8



1
0,193 m³



14 pz



ODS

BIANCO

vern. bianco

47553.00.000

ANTRACITE *

vern. antracite

47552.02.000

CAFFÈ *

vern. caffè

47557.05.000

TORTORA

vern. tortora

47559.10.000

€ 422,50

LEVANTE

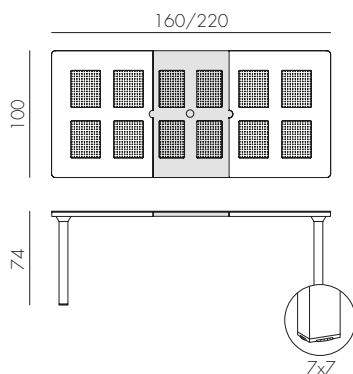

PP

DT

AL-V



29,6



1
0,193 m³



14 pz



ODS

BIANCO

vern. bianco

47053.00.000

ANTRACITE *

vern. antracite

47052.02.000

CAFFÈ *

vern. caffè

47057.05.000

TORTORA

vern. tortora

47059.10.000

€ 422,50

MAESTRALE 220

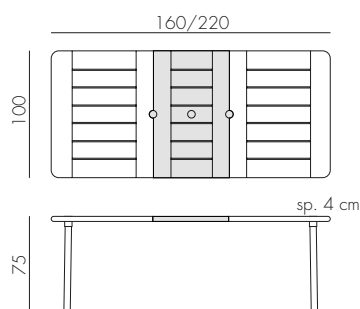

PP

DT

AL-V



31,3



1
0,150 m³



15 pz



ODS

BIANCO

vern. bianco

42253.00.000

ANTRACITE *

vern. antracite

42252.02.000

CAFFÈ *

vern. caffè

42257.05.000

TORTORA

vern. tortora

42259.10.000

€ 398,00

* Piani da utilizzare solo in zone ombreggiate
Only use table tops in shaded areas

modello model	info info	colore piano top colour	gambe in alluminio aluminium legs	ref. ref.	€ €
MAESTRALE 90					
	 PP DT AL-V	 11,7 1 0,086 m ³ 24 pz CADS	BIANCO vern. bianco 42053.00.000	€ 174,50	
			ANTRACITE vern. antracite 42052.02.000		
CAFFÈ vern. caffè 42057.05.000					
TORTORA vern. tortora 42059.10.000					
CUBE 80					
	 PP DT AL-V	 11,5 1 0,087 m ³ 18 pz CADS	BIANCO vern. bianco 48053.00.000	€ 199,00	
			ANTRACITE vern. antracite 48052.02.000		
CAFFÈ vern. caffè 48057.05.000					
TORTORA vern. tortora 48059.10.000					
CUBE 70					
	 PP DT AL-V	 9,5 1 0,066 m ³ 18 pz CADS	BIANCO vern. bianco 47853.00.000	€ 189,00	
			ANTRACITE vern. antracite 47852.02.000		
CAFFÈ vern. caffè 47857.05.000					
TORTORA vern. tortora 47859.10.000					
KIT CUBE 80 HIGH NEW					
	 PP AL-V	 4,4 1 0,019 m ³ 90 pz CADS	vern. bianco 48153.00.000	€ 89,50	
			vern. antracite 48152.02.000		
vern. caffè 48157.05.000					
vern. tortora 48159.10.000					

modello
model

info
info

colore piano
top colour

gambe in alluminio
aluminium legs

ref.
ref.

€
€

KIT CUBE 70 HIGH

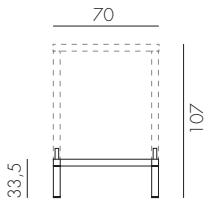

PP

AL-V



4



1
0,016 m³



90 pz



ODS



vern. bianco

47953.00.000



vern. antracite

47952.02.000



vern. caffè

47957.05.000



vern. tortora

47959.10.000

€ 85,00

TAVOLI
IN VETRO
E ALLUMINIO

glass and
aluminium tables

modello
model

info
info

colore piano
top colour

gambe in alluminio
aluminium legs

ref.
ref.

€
€

LOTO DINNER 190

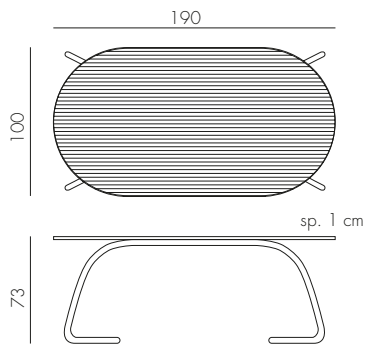

49,8
 1
0,227 m³
 10 pz

CADIS

BIANCO
 ANTRACITE

vern. bianco
 vern. antracite

44053.00.000
44052.02.000

€ 717,50

LOTO DINNER Ø170

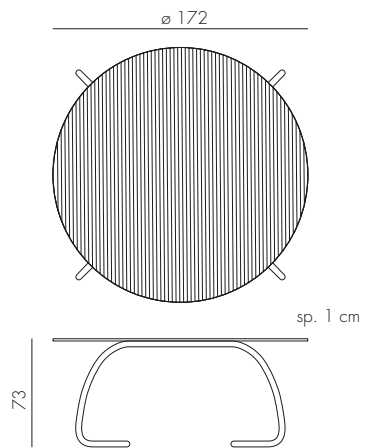

65,3
 1
1,026 m³
 1 pz

CADIS

BIANCO
 ANTRACITE

vern. bianco
 vern. antracite

44453.00.000
44452.02.000

€ 1302,00

LOTO DINNER Ø120

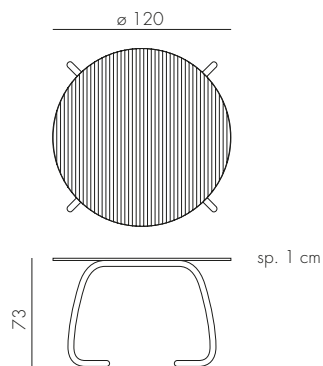

34
 1
0,182 m³
 10 pz

CADIS

BIANCO
 ANTRACITE

vern. bianco
 vern. antracite

44353.00.000
44352.02.000

€ 629,50

modello
model

info
info

colore piano
top colour

gambe in alluminio
aluminium legs

ref.
ref.

€
€

LOTO RELAX 95

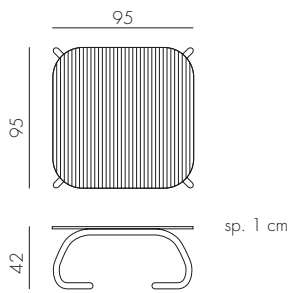

AL-V

V-T-S



27



1
0,143 m³



10 pz



ODS

BIANCO

ANTRACITE

vern. bianco

vern. antracite

44753.00.000

44752.02.000

€ 497,00

LOTO RELAX 60

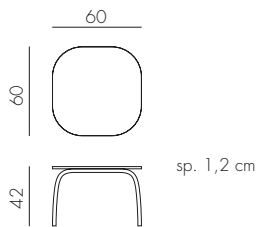

AL-V

LAM



7



1
0,019 m³



30 pz



ODS

BIANCO

ANTRACITE

vern. bianco

vern. antracite

44653.00.301

44652.00.303

€ 221,00

TAVOLI POLO

polo tables

modello model	info info	colore piano colour top	poliprop./gambe in alluminio polyprop./aluminium legs	ref. ref.	€ €	
POLO 70X70 DURELTOP						
		8,4 1 0,069 m ³ 15 pz	<input type="checkbox"/> BIANCO	<input type="checkbox"/> BIANCO/anodizzato	50750.00.400	€ 162,00
			<input checked="" type="checkbox"/> GRIGIO	<input checked="" type="checkbox"/> ANTRAC./anodizzato	50750.02.403	
			<input checked="" type="checkbox"/> GRIGIO	<input checked="" type="checkbox"/> GRIGIO/anodizzato	50750.03.403	
			<input checked="" type="checkbox"/> ANTRACITE*	<input checked="" type="checkbox"/> ANTRACITE/vern. antrac.	50752.02.402	
POLO 80X80 DURELTOP						
		8,6 1 0,083 m ³ 15 pz	<input type="checkbox"/> BIANCO	<input type="checkbox"/> BIANCO/anodizzato	50850.00.400	€ 187,00
			<input checked="" type="checkbox"/> GRIGIO	<input checked="" type="checkbox"/> ANTRAC./anodizzato	50850.02.403	
			<input checked="" type="checkbox"/> GRIGIO	<input checked="" type="checkbox"/> GRIGIO/anodizzato	50850.03.403	
			<input checked="" type="checkbox"/> ANTRACITE*	<input checked="" type="checkbox"/> ANTRACITE/vern. antrac.	50852.02.402	

* Piani da utilizzare solo in zone ombreggiate
Only use table tops in shaded areas

modello
model

info
info

colore piano
colour top

poliprop./gambe in alluminio
polyprop./aluminium legs

ref.
ref.

€
€

POLO Ø60 WERZALIT-TOPALIT

					BIANCO BIANCO/anodizzato 51650.00.190	€ 149,50
					ARGENTO. ANTRAC./anodizzato 51650.02.197	
					ARGENTO GRIGIO/anodizzato 51650.03.197	

POLO Ø70 WERZALIT-TOPALIT

					BIANCO BIANCO/anodizzato 51750.00.190	€ 165,00
					ARGENTO. ANTRAC./anodizzato 51750.02.197	
					ARGENTO GRIGIO/anodizzato 51750.03.197	

POLO Ø80 WERZALIT-TOPALIT

					BIANCO BIANCO/anodizzato 51850.00.190	€ 177,50
					ARGENTO. ANTRAC./anodizzato 51850.02.197	
					ARGENTO GRIGIO/anodizzato 51850.03.197	

modello model	info info	colore piano colour top	poliprop./gambe in alluminio polyprop./aluminium legs	ref. ref.	€ €	
POLO 60X60 WERZALIT-TOPALIT						
	 PP AL-A	 8,6 1 0,056 m ³ 15 pz CADIS	<input type="checkbox"/> BIANCO	<input type="checkbox"/> BIANCO/anodizzato	50650.00.190	€ 172,50
			<input checked="" type="checkbox"/> ARGENTO	<input checked="" type="checkbox"/> ANTRAC./anodizzato	50650.02.197	
			<input checked="" type="checkbox"/> ARGENTO	<input checked="" type="checkbox"/> GRIGIO/anodizzato	50650.03.197	
POLO 70X70 WERZALIT-TOPALIT						
	 PP AL-A	 10,2 1 0,069 m ³ 15 pz CADIS	<input type="checkbox"/> BIANCO	<input type="checkbox"/> BIANCO/anodizzato	50750.00.190	€ 203,00
			<input checked="" type="checkbox"/> ARGENTO	<input checked="" type="checkbox"/> ANTRAC./anodizzato	50750.02.197	
			<input checked="" type="checkbox"/> ARGENTO	<input checked="" type="checkbox"/> GRIGIO/anodizzato	50750.03.197	
POLO 80X80 WERZALIT-TOPALIT						
	 PP AL-A	 12,7 1 0,083 m ³ 15 pz CADIS	<input type="checkbox"/> BIANCO	<input type="checkbox"/> BIANCO/anodizzato	50850.00.190	€ 219,00
			<input checked="" type="checkbox"/> ARGENTO	<input checked="" type="checkbox"/> ANTRAC./anodizzato	50850.02.197	
			<input checked="" type="checkbox"/> ARGENTO	<input checked="" type="checkbox"/> GRIGIO/anodizzato	50850.03.197	

modello
model

info
info

colore piano
colour top

poliprop./gambe in alluminio
polyprop./aluminium legs

ref.
ref.

€
€

POLO 110X70 WERZALIT-TOPALIT

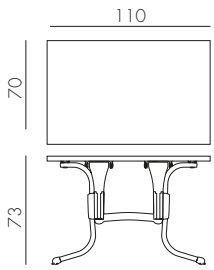

16,7
 1 0,108 m³
 15 pz
 OUTDOOR

BIANCO
 ARGENTO
 ARGENTO

BIANCO/anodizzato
 ANTRAC./anodizzato
 GRIGIO/anodizzato

51150.00.190
51150.02.197
51150.03.197

€ 260,50

POLO 120X80 WERZALIT-TOPALIT

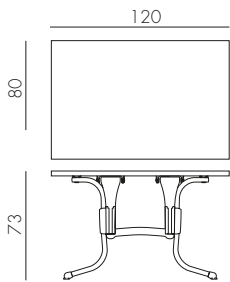

20,1
 1 0,124 m³
 15 pz
 OUTDOOR

BIANCO
 ARGENTO
 ARGENTO









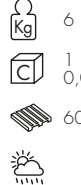

BIANCO/anodizzato
 ANTRAC./anodizzato
 GRIGIO/anodizzato

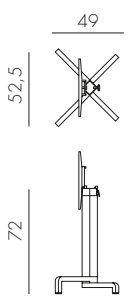
51250.00.190
51250.02.197
51250.03.197

€ 295,50

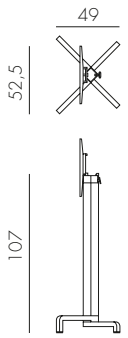
BASI IN ALLUMINIO

aluminium bases

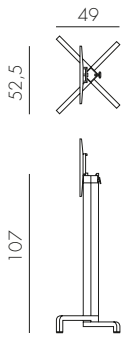
modello model	info info	colore colour	ref. ref.	€
BASE IBISCO				
Top ø60 - ø70 - ø80 - 60x60 - 70x70 - 80x80				54552.00.000 54553.00.000 54554.00.000 54557.00.000 54559.00.000
				
BASE IBISCO HIGH				
Top ø60 - ø70 - 60x60 - 70x70				54652.00.000 54653.00.000 54654.00.000 54657.00.000 54659.00.000
				
BASE IBISCO HIGH				
Top ø60 - ø70 - 60x60 - 70x70				54652.00.000 54653.00.000 54654.00.000 54657.00.000 54659.00.000
				

Qualora il prodotto venga posizionato in ambienti altamente salini raccomandiamo di scegliere una base con trattamento speciale.
 If the product is placed in highly salty environments, we recommend choosing a base with a special treatment.

modello
model

info
info

colore
colour

ref.
ref.

€
€

BASE FIORE

Top ø60 - ø70 - ø80 - 60x60 - 70x70 - 80x80

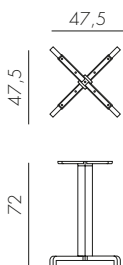

AL-V



5



1
0,017 m³



30 pz



ODS

	vern. antracite	53052.00.000
	vern. bianco	53053.00.000
	vern. argento	53054.00.000
	vern. caffè	53057.00.000
	vern. tortora	53059.00.000

€ 129,00

AL-ST

	vern. antracite	53052.00.000.01
	vern. bianco	53053.00.000.01
	vern. argento	53054.00.000.01
	vern. caffè	53057.00.000.01
	vern. tortora	53059.00.000.01

€ 141,50

BASE FIORE HIGH

Top ø60 - ø70 - 60x60 - 70x70

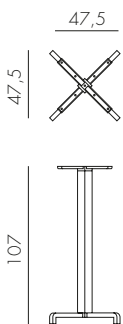

AL-V



5,7



1
0,064 m³



60 pz



ODS

	vern. antracite	53152.00.000
	vern. bianco	53153.00.000
	vern. argento	53154.00.000
	vern. caffè	53157.00.000
	vern. tortora	53159.00.000











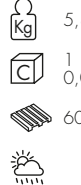

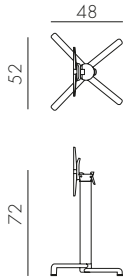









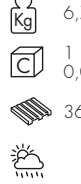

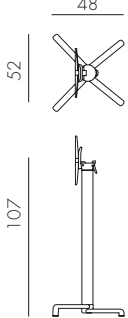





€ 149,00

AL-ST

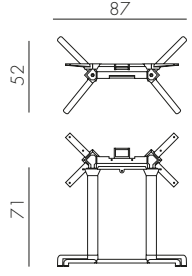
	vern. antracite	53152.00.000.01
	vern. bianco	53153.00.000.01
	vern. argento	53154.00.000.01
	vern. caffè	53157.00.000.01
	vern. tortora	53159.00.000.01

€ 163,00

Qualora il prodotto venga posizionato in ambienti altamente salini raccomandiamo di scegliere una base con trattamento speciale.
If the product is placed in highly salty environments, we recommend choosing a base with a special treatment.

modello model	info info	colore colour	ref. ref.	€	
BASE SCUDO					
Top ø60 - ø70 - ø80 - 60x60 - 70x70 - 80x80		 5,8 1 0,026 m ³ 60 pz	 vern. antracite	54052.00.000	€ 155,50
				 CADS	
	 vern. argento	54054.00.000			
			 vern. tortora	54059.00.000	
			 vern. antracite	54052.00.000.01	€ 170,00
			 vern. bianco	54053.00.000.01	
			 vern. argento	54054.00.000.01	
			 vern. tortora	54059.00.000.01	
BASE SCUDO HIGH					
Top ø60 - ø70 - 60x60 - 70x70		 6,7 1 0,064 m ³ 36 pz	 vern. antracite	54152.00.000	€ 174,50
				 CADS	
	 vern. tortora	54159.00.000			
			 vern. antracite	54152.00.000.01	
			 vern. argento	54154.00.000.01	
			 vern. tortora	54159.00.000.01	
BASE SCUDO DOUBLE					
Top 110x70 - 120x80		 8,7 1 0,030 m ³ 30 pz	 vern. antracite	54352.00.000	€ 234,00
				 CADS	
	 vern. tortora	54359.00.000			
			 vern. antracite	54352.00.000.01	
			 vern. argento	54354.00.000.01	
			 vern. tortora	54359.00.000.01	

Qualora il prodotto venga posizionato in ambienti altamente salini raccomandiamo di scegliere una base con trattamento speciale.
 If the product is placed in highly salty environments, we recommend choosing a base with a special treatment.

modello
model

info
info

colore
colour

ref.
ref.

€
€

BASE CALICE ALU

Top ø60 - ø70 - ø80 - 60x60 - 70x70 - 80x80

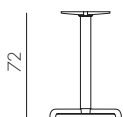
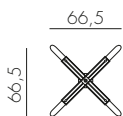

AL-V



4,5



1
0,017 m³



30 pz



ODS

	vern. antracite	52652.00.000	€ 129,00
	vern. bianco	52653.00.000	
	vern. argento	52654.00.000	
	vern. tortora	52659.00.000	

AL-ST			€ 141,50
	vern. antracite	52652.00.000.01	
	vern. bianco	52653.00.000.01	
	vern. argento	52654.00.000.01	
	vern. tortora	52659.00.000.01	

BASE CALICE ALU HIGH

Top ø60 - ø70 - 60x60 - 70x70

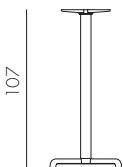
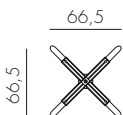

AL-V



5,5



1
0,064 m³



60 pz











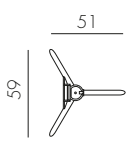









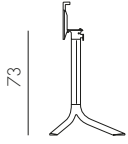





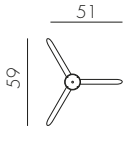



ODS

	vern. antracite	52752.00.000	€ 149,00
	vern. bianco	52753.00.000	
	vern. argento	52754.00.000	
	vern. tortora	52759.00.000	

AL-ST			€ 163,50
	vern. antracite	52752.00.000.01	
	vern. bianco	52753.00.000.01	
	vern. argento	52754.00.000.01	
	vern. tortora	52759.00.000.01	

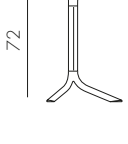
Qualora il prodotto venga posizionato in ambienti altamente salini raccomandiamo di scegliere una base con trattamento speciale.
If the product is placed in highly salty environments, we recommend choosing a base with a special treatment.

modello model	info info	colore colour	ref. ref.	€	
BASE FLUTE					
Top ø60 - ø70 	 4,9  1 0,073 m ³  32 pz  CADIS  AL-V	 vern. antracite  vern. bianco  vern. argento  vern. tortora	55652.00.000 55653.00.000 55654.00.000 55659.00.000	€ 142,50	
		 vern. antracite  vern. bianco  vern. argento  vern. tortora	55652.00.000.01 55653.00.000.01 55654.00.000.01 55659.00.000.01		€ 156,50











































BASE BREAK					
Top ø60 - ø70 	 4,3  1 0,073 m ³  32 pz  CADIS  AL-V	 vern. antracite  vern. bianco  vern. argento  vern. tortora	55852.00.000 55853.00.000 55854.00.000 55859.00.000	€ 110,00	
		 vern. antracite  vern. bianco  vern. argento  vern. tortora	55852.00.000.01 55853.00.000.01 55854.00.000.01 55859.00.000.01		€ 121,00

Qualora il prodotto venga posizionato in ambienti altamente salini raccomandiamo di scegliere una base con trattamento speciale.
 If the product is placed in highly salty environments, we recommend choosing a base with a special treatment.











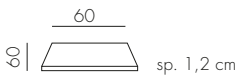
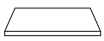

















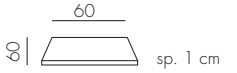

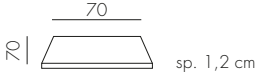
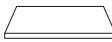

















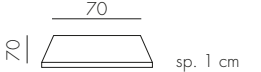
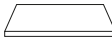
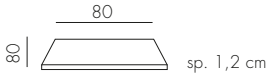
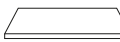







PIANI

tops







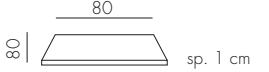
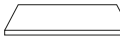



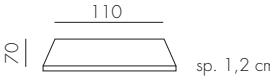



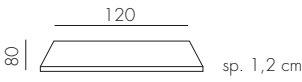

PIANI LAMINATO / laminate tops (CALICE - SCUDO - SCUDO DOUBLE - IBISCO - FIORE - FLUTE - BREAK - BASE CLIP)

modello model	info info	colore colour	ref. ref.	€ €	
PIANO LAMINATO Ø60					
 <p>Ø60 sp. 1,2 cm</p>		 4,5  2 0,017 m ³  60 pz 	 GRIGIO	30616.10.300	€ 99,50
			 BIANCO	30616.10.301	
			 CAFFÈ *	30616.10.302	
			 ANTRACITE *	30616.10.303	
			 CEMENTO	30616.10.305	
			 TORTORA	30616.10.310	
			 LEGNO	30616.10.311	
			 CORTEN *	30616.10.312	
PIANO LAMINATO Ø70					
 <p>Ø70 sp. 1,2 cm</p>		 6,2  2 0,023 m ³  60 pz 	 GRIGIO	30617.10.300	€ 132,00
			 BIANCO	30617.10.301	
			 CAFFÈ *	30617.10.302	
			 ANTRACITE *	30617.10.303	
			 CEMENTO	30617.10.305	
			 TORTORA	30617.10.310	
			 LEGNO	30617.10.311	
			 CORTEN *	30617.10.312	
PIANO LAMINATO Ø80					
 <p>Ø80 sp. 1,2 cm</p>		 8,1  2 0,030 m ³  60 pz 	 GRIGIO	30618.10.300	€ 167,50
			 BIANCO	30618.10.301	
			 CAFFÈ *	30618.10.302	
			 ANTRACITE *	30618.10.303	
			 CEMENTO	30618.10.305	
			 TORTORA	30618.10.310	
			 LEGNO	30618.10.311	
			 CORTEN *	30618.10.312	

* Piani da utilizzare solo in zone ombreggiate
Only use table tops in shaded areas

modello model	info info	colore colour	ref. ref.	€ €
PIANO LAMINATO 60X60				
 60  sp. 1,2 cm	 	 5,8  2 0,017 m ³  60 pz 	 GRIGIO 30606.10.300	€ 99,50
			 BIANCO 30606.10.301	
 CAFFÈ * 30606.10.302				
 ANTRACITE * 30606.10.303				
 CEMENTO 30606.10.305				
 TORTORA 30606.10.310				
 LEGNO 30606.10.311				
 CORTEN * 30606.10.312				
 4,9	 TOTAL WHITE 30606.10.314  NERO FENIX NTM® * 30606.10.313	€ 124,00 € 154,00		
 60  sp. 1 cm NEW				
PIANO LAMINATO 70X70				
 70  sp. 1,2 cm	 	 7,9  2 0,023 m ³  60 pz 	 GRIGIO 30607.10.300	€ 132,00
			 BIANCO 30607.10.301	
 CAFFÈ * 30607.10.302				
 ANTRACITE * 30607.10.303				
 CEMENTO 30607.10.305				
 TORTORA 30607.10.310				
 LEGNO 30607.10.311				
 CORTEN * 30607.10.312				
 6,6	 TOTAL WHITE 30607.10.314  NERO FENIX NTM® * 30607.10.313	€ 159,00 € 188,00		
 70  sp. 1 cm NEW				
PIANO LAMINATO 80X80				
 80  sp. 1,2 cm	 	 10,9  2 0,030 m ³  60 pz 	 GRIGIO 30608.10.300	€ 167,50
			 BIANCO 30608.10.301	
 CAFFÈ * 30608.10.302				
 ANTRACITE * 30608.10.303				
 CEMENTO 30608.10.305				
 TORTORA 30608.10.310				
 LEGNO 30608.10.311				
 CORTEN * 30608.10.312				
 9,2	 TOTAL WHITE 30608.10.314  NERO FENIX NTM® * 30608.10.313	€ 194,00 € 239,00		
 80  sp. 1 cm NEW				

* Piani da utilizzare solo in zone ombreggiate
 Only use table tops in shaded areas

modello model	info info	colore colour	ref. ref.	€ €	
PIANO LAMINATO 110X70					
	 	 12,4  2 0,035 m ³  40 pz 	 GRIGIO	30621.10.300	€ 227,00
			 BIANCO	30621.10.301	
PIANO LAMINATO 120X80					
	 	 15,5  2 0,044 m ³  40 pz 	 GRIGIO	30620.10.300	€ 266,00
			 BIANCO	30620.10.301	

PIANI WERZALIT-TOPALIT CON INSERTI / werzalit-topalit tops with inserts (CALICE - SCUDO - SCUDO DOUBLE - IBISCO - FIORE - FLUTE - BREAK - BASE CLIP)

modello model	info info	colore colour	ref. ref.	€ €	
PIANO WERZALIT-TOPALIT Ø60 (CON INSERTI/WITH INSERTS)					
 <p>ø60 sp. 2,6 cm</p>		 4	 BIANCO	30016.10.190	
		 1 0,017 m ³	 ARGENTO	30016.10.197	€ 65,00
		 40 pz	 WICKER *	30016.10.198	
					
PIANO WERZALIT-TOPALIT Ø70 (CON INSERTI/WITH INSERTS)					
 <p>ø70 sp. 2,6 cm</p>		 4,9	 BIANCO	30017.10.190	
		 1 0,019 m ³	 ARGENTO	30017.10.197	€ 80,50
		 40 pz	 WICKER *	30017.10.198	
					
PIANO WERZALIT-TOPALIT Ø80 (CON INSERTI/WITH INSERTS)					
 <p>ø80 sp. 2,6 cm</p>		 6,8	 BIANCO	30018.10.190	
		 1 0,025 m ³	 ARGENTO	30018.10.197	€ 84,00
		 40 pz	 WICKER *	30018.10.198	
					
PIANO WERZALIT-TOPALIT 60X60 (CON INSERTI/WITH INSERTS)					
 <p>60 sp. 3 cm</p>		 4,9	 BIANCO	30006.10.190	
		 1 0,015 m ³	 ARGENTO	30006.10.197	€ 87,00
		 40 pz	 WICKER *	30006.10.198	
					
PIANO WERZALIT-TOPALIT 70X70 (CON INSERTI/WITH INSERTS)					
 <p>70 sp. 3 cm</p>		 7,2	 BIANCO	30007.10.190	
		 1 0,020 m ³	 ARGENTO	30007.10.197	€ 106,50
		 40 pz	 WICKER *	30007.10.198	
					
PIANO WERZALIT-TOPALIT 80X80 (CON INSERTI/WITH INSERTS)					
 <p>80 sp. 3,3 cm</p>		 9,2	 BIANCO	30008.10.190	
		 1 0,026 m ³	 ARGENTO	30008.10.197	€ 124,00
		 40 pz	 WICKER *	30008.10.198	
					

* Piani da utilizzare solo in zone ombreggiate
Only use table tops in shaded areas

modello
model

info
info

colore
colour

ref.
ref.

€
€

PIANO WERZALIT-TOPALIT 110X70 (CON INSERTI/WITH INSERTS)

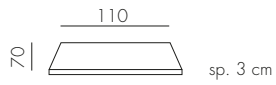

10,8



1
0,035 m³



40 pz



BIANCO

30021.10.190

€ 143,00

ARGENTO

30021.10.197

PIANO WERZALIT-TOPALIT 120X80 (CON INSERTI/WITH INSERTS)

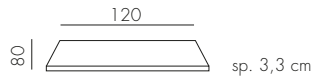

15



1
0,044 m³



40 pz



BIANCO



















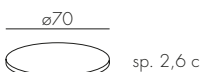







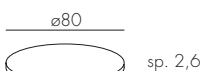







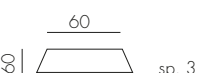







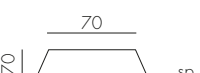



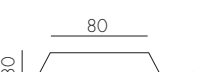

30020.10.190

€ 175,50











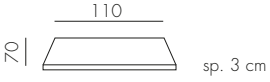

ARGENTO

30020.10.197

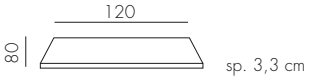









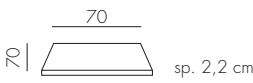











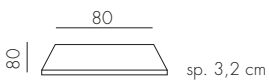

PIANI WERZALIT-TOPALIT SENZA AGGANCI O INSERTI (PIANI SCIOLTI) / werzalit-topalit top without hooks or inserts (loose tops)

modello model	info info	colore colour	ref. ref.	€ €	
PIANO WERZALIT-TOPALIT Ø60					
 <p>ø60 sp. 2,6 cm</p>		 4,3	 BIANCO	1801430.00.190	
		 1 0,011 m ³	 ARGENTO	1801430.00.197	€ 50,00
		 60 pz	 WICKER *	1801430.00.198	
					
PIANO WERZALIT-TOPALIT Ø70					
 <p>ø70 sp. 2,6 cm</p>		 5,1	 BIANCO	1801630.00.190	
		 1 0,012 m ³	 ARGENTO	1801630.00.197	€ 63,00
		 60 pz	 WICKER *	1801630.00.198	
					
PIANO WERZALIT-TOPALIT Ø80					
 <p>ø80 sp. 2,6 cm</p>		 6,9	 BIANCO	1801930.00.190	
		 1 0,016 m ³	 ARGENTO	1801930.00.197	€ 65,00
		 60 pz	 WICKER *	1801930.00.198	
					
PIANO WERZALIT-TOPALIT 60X60					
 <p>60 sp. 3 cm</p>		 5	 BIANCO	1801530.00.190	
		 1 0,011 m ³	 ARGENTO	1801530.00.197	€ 72,00
		 60 pz	 WICKER *	1801530.00.198	
					
PIANO WERZALIT-TOPALIT 70X70					
 <p>70 sp. 3 cm</p>		 6,7	 BIANCO	1801730.00.190	
		 1 0,015 m ³	 ARGENTO	1801730.00.197	€ 90,00
		 50 pz	 WICKER *	1801730.00.198	
					
PIANO WERZALIT-TOPALIT 80X80					
 <p>80 sp. 3,3 cm</p>		 9,5	 BIANCO	1801830.00.190	
		 1 0,019 m ³	 ARGENTO	1801830.00.197	€ 106,50
		 50 pz	 WICKER *	1801830.00.198	
					

* Piani da utilizzare solo in zone ombreggiate
Only use table tops in shaded areas

modello model	info info	colore colour	ref. ref.	€ €	
PIANO WERZALIT-TOPALIT 110X70					
		 10,8	<input type="checkbox"/> BIANCO	1802130.00.190	€ 121,50
		 1 0,023 m ³	<input checked="" type="checkbox"/> ARGENTO	1802130.00.197	
		 50 pz			
					
PIANO WERZALIT-TOPALIT 120X80					
		 15	<input type="checkbox"/> BIANCO	1802030.00.190	€ 154,00
		 1 0,029 m ³	<input checked="" type="checkbox"/> ARGENTO	1802030.00.197	
		 50 pz			
					

PIANI DURELTOP / durelTop tops (CALICE - SCUDO - IBISCO - FIORE - BASE CLIP)

modello model	info info	colore colour	ref. ref.	€ €				
PIANO DURELTOP 70X70								
 <p>70  sp. 2,2 cm</p>	 	 3,9  1 0,020 m ³  40 pz 	 BIANCO  ANTRACITE *  GRIGIO  CAFFÈ *  TORTORA	30207.00.400 30207.00.402 30207.00.403 30207.00.405 30207.00.410	€ 68,00			
		PIANO DURELTOP 80X80						
		 <p>80  sp. 3,2 cm</p>	 	 7,2  1 0,030 m ³  40 pz 		 BIANCO  ANTRACITE *  GRIGIO  CAFFÈ *  TORTORA	30208.00.400 30208.00.402 30208.00.403 30208.00.405 30208.00.410	€ 94,00

* Piani da utilizzare solo in zone ombreggiate
 Only use table tops in shaded areas

CUSCINI E
ACCESSORI

cushions and
accessories

modello
model

info
info

tessuto
fabric

ref.
ref.

€
€

CUSCINO NET BENCH

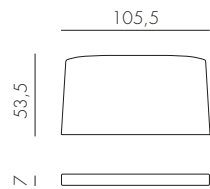

grey stone	36338.00.064
rosa quarzo	36338.00.066
senape	36338.00.069
denim	36338.00.070
the verde	36338.00.071
sardinia	36338.00.072
bianco	36338.00.155
grigio	36338.00.163
grigio Sunbrella®	36338.00.136

€ 96,00

€ 139,00

CUSCINO NET RELAX

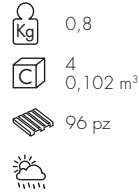
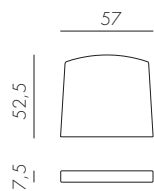

grey stone	36327.00.064
rosa quarzo	36327.00.066
senape	36327.00.069
denim	36327.00.070
the verde	36327.00.071
sardinia	36327.00.072
bianco	36327.00.155
grigio	36327.00.163
grigio Sunbrella®	36327.00.136

€ 55,00

€ 82,00

CUSCINO SHELL NET RELAX

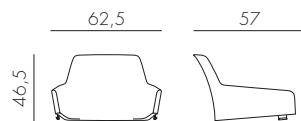

rosa quarzo	36327.01.066
denim	36327.01.070
grigio	36327.01.163

€ 149,00

CUSCINO NET

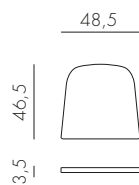

grey stone	36326.00.064
rosa quarzo	36326.00.066
senape	36326.00.069
denim	36326.00.070
the verde	36326.00.071
sardinia	36326.00.072
bianco	36326.00.155
grigio	36326.00.163
grigio Sunbrella®	36326.00.136

€ 29,00

€ 49,00

modello
model

info
info

tessuto
fabric

ref.
ref.

€
€

CUSCINO PASSEPARTOUT

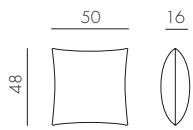

0,7
 4
0,152 m³
 64 pz

	grey stone	36000.01.064
	rosa quarzo	36000.01.066
	senape	36000.01.069
	denim	36000.01.070
	the verde	36000.01.071
	sardinia	36000.01.072
	tropical	36000.01.081
	bianco	36000.01.155
	grigio	36000.01.163
	grigio Sunbrella®	36000.01.136
	canvas Sunbrella®	36000.01.141
	adriatic Sunbrella®	36000.01.142

€ 49,00

€ 68,00

CUSCINO TRILL **NEW**

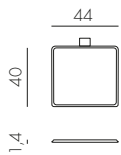

0,2
 4
0,012 m³
 480 pz

	cenere	36253.00.132

€ 49,00

modello
model

info
info

tessuto
fabric

ref.
ref.

€
€

CUSCINO SEDUTA ARIA

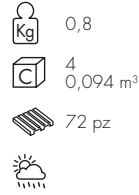
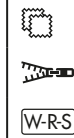
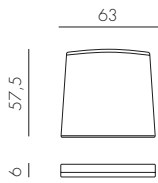







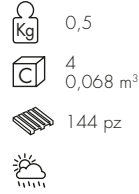
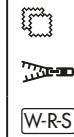
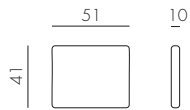

 lime	36330.00.061
 cherry	36330.00.065
 melanzana	36330.00.068
 bianco	36330.00.155
 caffè	36330.00.165
 grigio	36330.00.163
 grigio Sunbrella®	36330.00.136

€ 55,00

€ 82,00

CUSCINO ARREDO ARIA



 lime	36330.01.061
 cherry	36330.01.065
 melanzana	36330.01.068
 bianco	36330.01.155
 caffè	36330.01.165
 grigio	36330.01.163
 grigio Sunbrella®	36330.01.136

€ 34,00

€ 49,00

CUSCINO FIT ARIA

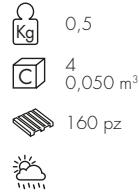
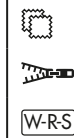
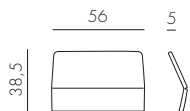

 bianco	36330.04.155
 caffè	36330.04.165
 grigio	36330.04.163
 grigio Sunbrella®	36330.04.136

€ 90,00

€ 115,00

modello
model

info
info

tessuto
fabric

ref.
ref.

€
€

CUSCINO ACQUAMARINA

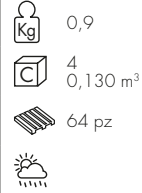
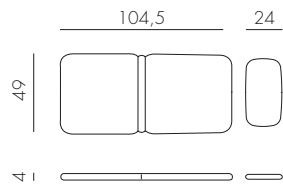

36314.00.155

36314.00.163

36314.00.165

36314.00.136

€ 75,00

€ 125,00

CUSCINO DARSENA

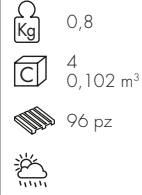
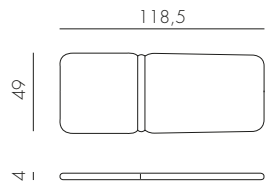

36316.00.155

36316.00.163

36316.00.165

36316.00.136

€ 68,00

€ 119,00

CUSCINO EDEN

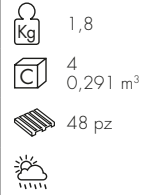
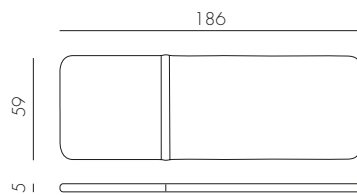

36414.01.160

36414.00.076

€ 115,50

DETERGENTE CLEAN RESIN 0,5 LT



39101.00.000

€ 5,70

DETERGENTE CLEAN RESIN SPECIAL 5 LT

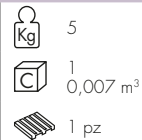

39102.00.000

€ 135,00

MATERIALI

materials

RESINA/RESIN

POLIPROPILENE/polypropylene

Polipropilene trattato anti-UV e colorato in massa. Riciclabile al 100%.

Polypropylene with UV additives and is uniformly colored. 100% Recyclable resin.

POLIPROPILENE FIBERGLASS/polypropylene fiberglass

Polipropilene fiberglass trattato anti-UV e colorato in massa. Resina riciclabile al 100%.

Uniformly colored fiberglass polypropylene resins with uv additives. 100% Recyclable resin.

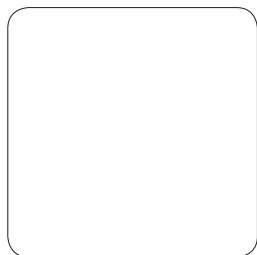

BIANCO .00



GRIGIO .03



ANTRACITE .02



BURRO .28

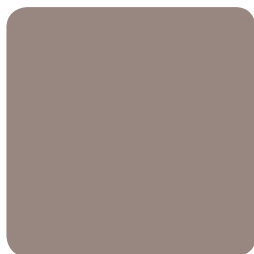

TORTORA .10



TABACCO .53



CAFFE' .05



CELESTE .39



OTTANIO .49



SALICE .04



LIME .12



AGAVE .16



SENAPE .56



CORALLO .75



ROSSO .07

TESSUTO/FABRIC

TESSUTO ACRILICO/acrilic fabric

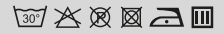

Fibra acrilica 100% tinto filo. Trattamento antimacchia, antimuffa. Solidità alla luce 5/8. Sfoderabile/zip, lavabile a 30°.

100% yarn dyed acrylic. Dirt repellent and anti-mould treatment. 5/8 light fastness. Removeable/zip, washable at 30°.



grigio .163
240 gr/m²



grey stone .064
240 gr/m²



the verde .071
240 gr/m²



lime .061
240 gr/m²



sardinia .072
240 gr/m²



denim .070
240 gr/m²



rosa quarzo .066
240 gr/m²



senape .069
240 gr/m²



cherry .065
240 gr/m²



melanzana .068
190 gr/m²

TESSUTO 100% OLEFIN / 100% olefin fabric



100% Olefin tinto in massa. Trattamento antimacchia, antimuffa. Solidità alla luce 7/8. Sfoderabile/zip, lavabile a 40°.

100% Olefin mass dyed. Dirt repellent and anti-mould treatment. 7/8 light fastness. Removeable/zip, washable at 40°.



bianco .155
190 gr/m²

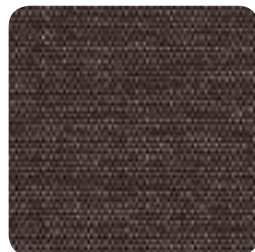

caffè .165
190 gr/m²

TESSUTO ACRILICO STAMPATO / acrylic fabric with digital print



Fibra acrilica 100% stampa digitale. Solidità alla luce 6.
Sfoderabile/zip, lavabile a 30°.

100% acrylic fiber with digital print. 6 light fastness.
Removeable/zip, washable at 30°.



tropical .081
190 gr/m²

TESSUTO ACRILICO SUNBRELLA® / Sunbrella® acrylic fabric



100% fibra acrilica SUNBRELLA® tinto in massa. Trattamento idrorepel-
lente, antimacchia, antimuffa. Solidità alla luce 8/8. Sfoderabile/zip,
lavabile a 40°.

100% SUNBRELLA® acrylic fiber mass dyed. Water repellent treatment, dirt
repellent and anti-mould treatment. 8/8 light fastness. Removeable/zip, wa-
shable at 40°.

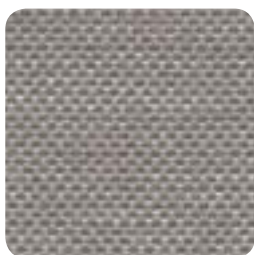

grigio Sunbrella® .136
275 gr/m²



canvas Sunbrella® .141
275 gr/m²

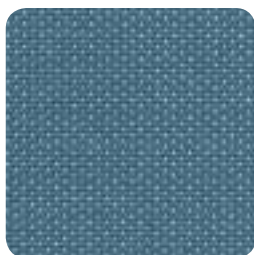

adriatic Sunbrella® .142
260 gr/m²

TESSUTO 100% OLEFIN CUSCINO EDEN / 100% olefin fabric Eden cushion



100% Olefin tinto in massa. Trattamento con resina poliuretanic/acrilica,
idrorepellente. Solidità alla luce 7/8. Sfoderabile/zip, lavabile a 40°.

100% Olefin mass dyed. Treatment with polyurethane/acrylic resin, water-re-
pellent. 7/8 light fastness. Removeable/zip, washable at 40°.



écru .160
220 gr/m²



blu .076
220 gr/m²

CUSCINO TRILL TERMOFORMATO/ thermoformed Trill cushion



TESSUTO SUNBRELLA® TERRY: 76% fibra acrilica SUNBRELLA® tinto in massa e 24% poliestere. Trattamento antimacchia, antimuffa. Solidità alla luce 7/8. Senza cuciture. Lavabile a 30°. Imbottitura: poliuretano espanso rivestito da membrana TPU waterproof. Densità 40 kg/m³.

SUNBRELLA® TERRY FABRIC: 76% SUNBRELLA® acrylic fiber mass dyed and 24% polyester. Dirt repellent and anti-mould treatment. 7/8 light fastness. Seamless. Washable at 30°. Padding: polyurethane foam with a TPU waterproof membrane. Density 40 kg/m³.

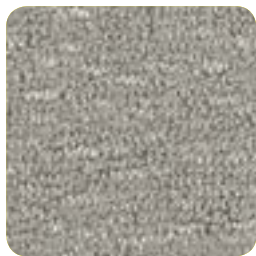

cenere .132

550 gr/m²

IMBOTTITURA / padding

CUSCINO NET BENCH - CUSCINO NET RELAX - CUSCINO NET - CUSCINO FIT ARIA - CUSCINO ACQUAMARINA - CUSCINO DARSENA

Poliuretano espanso. Densità 28 kg/m³. Polyurethane foam. Density 28 kg/m³.

CUSCINO SEDUTA ARIA

Poliuretano espanso. Densità 25 kg/m³. Polyurethane foam. Density 25 kg/m³.

CUSCINO SHELL NET RELAX

Poliuretano espanso su struttura rigida di polipropilene. Densità 70 kg/m³. Polyurethane foam over solid polypropylene frame. Density 70 kg/m³.

CUSCINO PASSEPARTOUT

Fibra di poliestere. Polyester fiber.

CUSCINO SEDUTA KOMODO - CUSCINO ARREDO ARIA

Poliuretano espanso (densità 25 kg/m³) rivestito da fibra di poliestere (densità 450 gr/m²). Polyurethane foam (density 25 kg/m³) with polyester fiber (density 450 gr/m²).

CUSCINO SCHIENALE KOMODO - CUSCINO SCHIENALE ANGOLO KOMODO

Poliuretano espanso (densità 21 kg/m³) rivestito da fibra di poliestere (densità 450 gr/m²). Polyurethane foam (density 21 kg/m³) with polyester fiber (density 450 gr/m²).

CUSCINO EDEN

Poliuretano espanso. Densità 18 kg/m³. Polyurethane foam. Density 18 kg/m³.

TESSUTO SINTETICO/synthetic fabric

Tessuto in filo di poliestere rivestito in pvc.

Fabric is made of a polyester fiber, with a pvc coating.

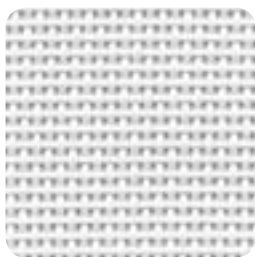

bianco .107
tela 1x1

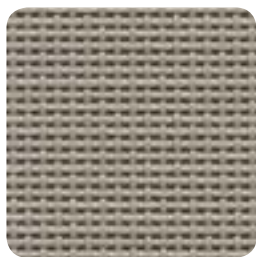

tortora .104
tela 1x1

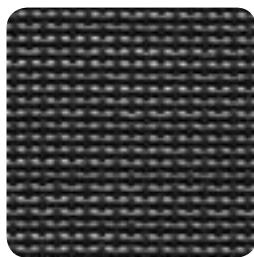

antracite .057
tela 1x1



mandarino .083
tela 1x1

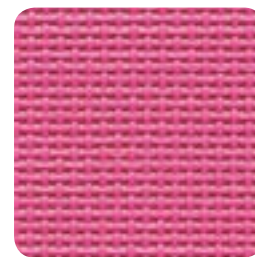

rosa .056
tela 1x1

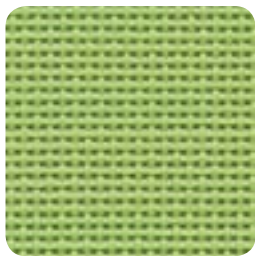

prato .084
tela 1x1

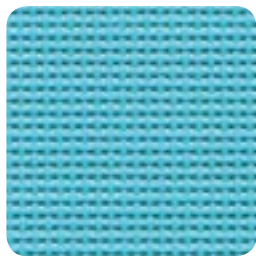

celestè .075
tela 1x1

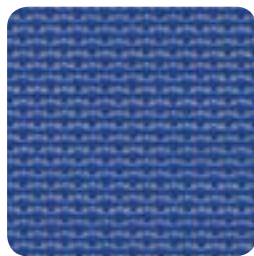

blu .102
tela 1x1



bianco .108
tela 2x2



beige .115
tela 2x2



tortora .124
tela 2x2

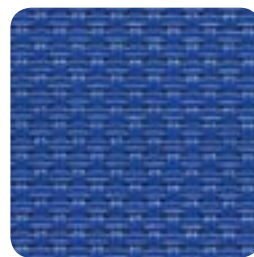

blu .112
tela 2x2



trama bianco .121



trama beige .078



trama caffè .117

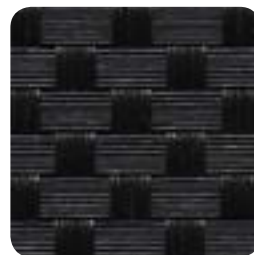

trama antracite .116

ALLUMINIO/ALUMINIUM

ALLUMINIO ANODIZZATO/aluminium anodized

L'anodizzazione è un processo elettrolitico che aumenta l'ossidazione delle superfici prevenendo la corrosione con uno strato protettivo.

Anodizing is an electrolytic procedure that increases oxidation of the surfaces, preventing corrosion with a protective layer.

ALLUMINIO VERNICIATO/coated aluminium

La verniciatura è a polvere di poliestere.

The painting is with polyester powder.

ALLUMINIO VERNICIATO TRATTAMENTO SPECIALE/coated aluminium special treatment

Alluminio con trattamento speciale per ambienti ad alto tasso salino.

Aluminium special treatment for high salinity environments.



verniciato bianco .53



verniciato argento .54



verniciato antracite .52



verniciato burro .58

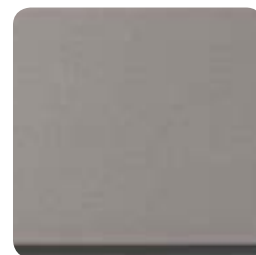

verniciato tortora .59



verniciato caffè' .57



anodizzato .50

LAMINATO/LAMINATE

LAMINATO HPL/laminate HPL

Laminato decorativo ad alta pressione, compatto, omogeneo, non poroso, ad alta densità. Spessore 12 mm.

Decorative high pressure laminate, solid, homogeneous, non-porous and with a high density. Thickness 12 mm.



BIANCO .301



GRIGIO .300



ANTRACITE .303



TORTORA .310



CAFFÈ .302



CEMENTO .305

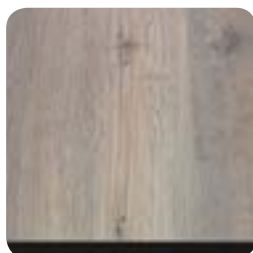

LEGNO .311

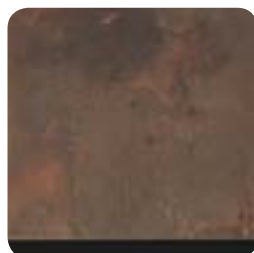

CORTEN .312

LAMINATO HPL SOLID CORE/laminate HPL Solid Core

Laminato decorativo ad alta pressione, compatto, omogeneo, non poroso, ad alta densità. Spessore 10 mm.

Decorative high pressure laminate, solid, homogeneous, non-porous and with a high density. Thickness 10 mm.



TOTAL WHITE .314

FENIX NTM® / SOLID

Spessore/thickness 10 mm.



NERO FENIX NTM® .313

WERZALIT-TOPALIT

WERZALIT® - TOPALIT®

Piano speciale protetto da laminato melamminico decorato, di facile pulizia, resistente alle macchie, al calore, alle intemperie.

Werzalit-topalit tops are protected by a special printed foil that is weather proof, easy to clean and resistant to marks and heat.



BIANCO .190



ARGENTO .197

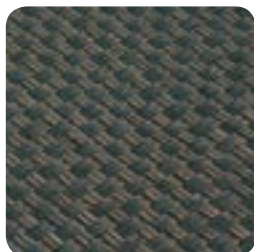

WICKER .198

VETRO/GLASS

VETRO/glass

Vetro float temperato serigrafato e vetrificato a 700°C. Spessore 10 mm.

Tempered Float glass, screen-printed and vitrified at 700° C. Thickness 10 mm.



BIANCO .00



ANTRACITE .02

DURELTOP

DURELTOP

DurelTOP è un sistema innovativo di produzione di piani per tavoli studiati per raggiungere i più elevati livelli di praticità, resistenza, robustezza ed eleganza. I piani DurelTOP sono ad alto spessore, formati da un doppio strato tamburato perfettamente chiuso. Prodotti in polipropilene di prima qualità, sono inalterabili all'acqua, resistenti al sole e facili da pulire. DurelTOP è il risultato di una lunga ricerca tecnologica e dell'esperienza decennale nella lavorazione delle materie plastiche della Nardi, da sempre all'avanguardia nell'ambiente contract e giardino.

The DurelTOP is an innovative new system in the production of tabletops developed to reach the highest levels of practicality, resistance, and elegance. The DurelTOP tabletops have a greater thickness, formed by a double layer enclosure perfectly closed. Produced in first quality polypropylene, they are resistant to water, resistant to sunlight, and are easy to clean. DurelTOP is a result of a decade's long research and development in plastics by Nardi, always a leader in the contract and garden sectors.



condizioni generali di vendita
general terms of sale

NARDI SPA – CONDIZIONI GENERALI DI VENDITA B2B - Italia

1. Informazioni generali

- 1.1 Tutti i contratti di vendita dei Prodotti saranno soggetti a questi Termini e Condizioni generali di Vendita le quali sostituiscono qualsiasi termine e condizione di vendita precedenti.
- 1.2 Inviando un ordine o accettando un preventivo il Compratore accetta queste Condizioni Generali di Vendita.
- 1.3 Eventuali condizioni generali di acquisto del Compratore non potranno ritenersi applicabili.
- 1.4 Le specifiche dei Prodotti, i listini e i cataloghi possono essere modificati in ogni momento da NARDI.
- 1.5 Sono da considerarsi articoli standard solo quelli indicati nel catalogo vigente al momento dell'ordine. I dati tecnici e le fotografie riportate nei cataloghi sono da considerarsi meramente indicativi.

2. Conclusione del contratto

- 2.1 Gli ordini verbali o telefonici e qualsiasi modifica agli ordini dovranno essere confermati per iscritto dal Compratore e saranno vincolanti solo quanto accettati per iscritto da NARDI. Le conferme d'ordine inviate da NARDI, qualora contengano variazioni rispetto l'ordine ricevuto, si intendono accettate se non contestate dal Compratore entro tre giorni dall'invio delle medesime.
- 2.2 In caso di ordini per Prodotti personalizzati, il Compratore deve inviare le informazioni necessarie per la realizzazione del Prodotto in modo chiaro e preciso. NARDI non è tenuta a verificare la correttezza e completezza delle istruzioni ricevute e non sarà responsabile per la mancata o errata comunicazione di dati o informazioni da parte del Compratore.

3. Prezzo

- 3.1 I prezzi indicati nel presente listino sono prezzi consigliati per l'Utilizzatore Finale e sono sempre Iva esclusa.
- 3.2 Il prezzo per il Compratore è quello che verrà espressamente indicato nella conferma d'ordine inviata da NARDI al Compratore.

4. Pagamento

- 4.1 Il Compratore deve effettuare il pagamento del prezzo rigorosamente nei termini e con le modalità indicate nella Conferma d'Ordine; tutte le spese inerenti il pagamento sono a carico del Compratore.
- 4.2 In mancanza di diversa indicazione, il Compratore dovrà pagare il prezzo interamente, in anticipo e a mezzo bonifico bancario. Le forniture personalizzate sono sempre subordinate al versamento di una caparra all'Ordine e a condizioni specifiche di pagamento.
- 4.3 Il luogo convenuto per il pagamento è CHIAMPPO (VI) Italia.
- 4.4 Salvo che sia diversamente stabilito, i costi di trasporto e spedizione, di assicurazione della merce durante il trasporto, lo sdoganamento dei prodotti e di ogni altra eventuale operazione accessoria ad esso connessa, oneri e tasse doganali sono sempre a carico del Compratore.
- 4.5 In caso di ritardato pagamento di qualsiasi somma dovuta a NARDI, oltre agli interessi di mora, ai sensi del Decreto Legislativo 231/2002 e della Direttiva 2000/35/CE il Compratore dovrà corrispondere a NARDI il rimborso delle spese amministrative di recupero credito.

5. Luogo di consegna

- 5.1. Luogo di consegna dei Prodotti è il magazzino di NARDI presso la sua sede legale in Chiampo, Via delle Stangà 14, Italia.
- 5.2. I termini resa (cd INCOTERMS) disciplinano solo i diritti e gli obblighi delle parti in relazione alla spedizione, ma non modificano il luogo di esecuzione dell'obbligo di consegna che rimane il magazzino di NARDI.

6. Data di consegna

- 6.1 La data di consegna è franco fabbrica ed è puramente indicativa e non vincolante per NARDI. Eventuali ritardi nella consegna, spedizione o trasporto non daranno luogo né a penalità, né a risarcimento danni, né a decorrenza di interessi, né a risoluzione, neanche parziale, del contratto, a carico di NARDI.

7. Imballaggio dei Prodotti

- 7.1 NARDI effettua l'imballaggio per la consegna o spedizione dei Prodotti nella forma standard, usuale per tali Prodotti ed il relativo costo

è incluso nel prezzo. Qualora il Compratore richieda uno speciale imballo, o qualora la modalità di spedizione lo richieda a giudizio di NARDI, gli eventuali maggiori costi potranno essere addebitati al Compratore.

- 7.2 I contributi per imballaggi diversi da quello Italiano non sono compresi nel prezzo e sono a carico del Compratore nel paese di destinazione, salvo diverse disposizioni.

8. Spedizione

- 8.1 In assenza di specifiche indicazioni i termini di resa si intendono EX WORKS (Incoterms CCI di Parigi) sede di NARDI Via delle Stangà 14- 36072 Chiampo (VI).
- 8.2 Quali che siano i termini di resa pattuiti dalle parti, NARDI si libera dal rischio al più tardi nel momento in cui il primo vettore ritira o prende in carico i Prodotti.
- 8.3 Quando il ritiro dei Prodotti è a carico del Compratore, il Compratore deve rispettare il protocollo per il ritiro dei Prodotti elaborato da NARDI.

9. Obblighi di verifica al ricevimento della merce

- 9.1 Il Compratore è tenuto ad esaminare i Prodotti, senza indugio, al ricevimento.
- 9.2 Unicamente quando la merce viaggia a carico di NARDI, nel caso in cui i Prodotti o il relativo imballaggio risultino danneggiati o in presenza di merce mancante, il Compratore è tenuto a firmare il documento di trasporto o il palmare con riserva specifica, indicando sempre il motivo della riserva. Copia di tale documento deve essere inviata a Nardi a mezzo mail entro 8 giorni dal ricevimento della merce. Non saranno gestiti reclami in mancanza di copia documento trasporto firmata con riserva e trascorso il termine suddetto. Restano salvi i danni non immediatamente riscontrabili al momento della ricezione della merce, che devono essere segnalati a mezzo mail, a pena di decadenza, entro 8 giorni dalla ricezione della merce.
- 9.3 Il Compratore deve in ogni caso verificare l'integrità degli articoli prima di trasferirli a terzi. A seguito del trasferimento non saranno accettati reclami per danni riconducibili al trasporto.

10. Garanzia

- 10.1 NARDI s'impegna, a sua esclusiva scelta, a sostituire, riparare o a rimborsare i prodotti difettosi, soltanto qualora i difetti siano dovuti alla materia prima utilizzata o alla fabbricazione e solo dopo aver esaminato il prodotto difettoso.
- 10.2 La garanzia secondo termini di legge decorre dalla data di consegna dei Prodotti da NARDI al Compratore. NARDI non accetterà resi o contestazioni dopo detti termini o a condizioni diverse.
- 10.3 I Prodotti sono garantiti da ogni difetto di fabbricazione in condizioni normali di utilizzo. A titolo esemplificativo, nessuna garanzia si applica a Prodotti:
 - a) che sono stati modificati o alterati o manomessi in qualunque modo da qualsiasi altro soggetto che non sia NARDI o un suo incaricato;
 - b) che sono stati utilizzati o conservati in condizioni ambientali diverse da quelle indicate da NARDI o comunque non adeguate al Prodotto.
- 10.4 La garanzia non copre le parti dei Prodotti soggette a normale usura e/o deterioramento o i difetti derivanti dal trasporto inadeguato.
- 10.5 L'utilizzo dei Prodotti dopo la scoperta dei difetti libera NARDI da ogni garanzia o responsabilità.
- 10.6 Sarà cura del Rivenditore sostituire il Prodotto all'Utilizzatore Finale nel minor tempo possibile utilizzando anche beni che ha in magazzino; salvo che sia diversamente concordato o le circostanze richiedano una spedizione dedicata, il Prodotto in sostituzione verrà inviato da NARDI alla prima spedizione utile.

11. Reclami

- 11.1 Qualsiasi mancanza di conformità, o difetto dei Prodotti, deve essere comunicata a mezzo mail, a pena di decadenza, entro e non oltre otto giorni:
 - a) dalla data di ricezione dei Prodotti da parte del Compratore in caso di vizi apparenti (e cioè tali che avrebbero dovuto essere

- scoperti da un Compratore diligente);
 b) dalla data di scoperta dei difetti, in caso di vizi occulti, e comunque non oltre termine previsto all'art. 10.2, dalla consegna dei Prodotti al Compratore.
- 11.2 I reclami dovranno indicare tutte le informazioni necessarie all'identificazione del problema, il numero di controllo qualità (presente sull'imballo e sul Prodotto), copia della fattura o dello scontrino con la relativa data di acquisto, eventuali foto o prove documentali della non conformità lamentata e l'indicazione della persona da contattare.
12. **Limitazione di responsabilità**
- 12.1 Fatta eccezione per il caso di dolo o colpa grave, NARDI non risponderà dei danni derivanti da o collegati a mancanza di conformità dei Prodotti o da ritardi nella consegna.
- 12.2 In ogni caso vi sia responsabilità di NARDI, l'ammontare del risarcimento per difetti e vizi dei Prodotti non potrà eccedere il valore del Prodotto pari al prezzo pagato dal Compratore.
- 12.3 E' escluso in ogni caso il diritto del Compratore alla risoluzione del contratto.
13. **Riserva di proprietà**
- 13.1 E' convenuto che i Prodotti consegnati restino di proprietà di NARDI fino a quando non sia pervenuto a quest'ultimo il completo pagamento; NARDI è pertanto autorizzata ad accedere ai locali dove il Compratore conserva di Prodotti per ritirarli.
14. **Inadempimento del Compratore**
- 14.1 Nel caso in cui il Compratore risulti inadempiente o vi sia comunque fondato motivo di ritenere che lo stesso non sia in grado di adempiere puntualmente i propri obblighi contrattuali, NARDI, a suo insindacabile giudizio, potrà sospendere l'esecuzione dei contratti in corso fino al completo saldo degli eventuali insoluti da parte del Compratore, considerare il Compratore decaduto dal beneficio del termine, eventualmente pattuito, richiedere il rilascio di idonee garanzie bancarie.
15. **Obblighi di riservatezza**
- 15.1 Tutte le notizie inerenti al know-how di cui NARDI è titolare, nonché le altre informazioni aziendali e commerciali, di cui il Compratore verrà a conoscenza nel corso delle trattative e dell'esecuzione del contratto (le Informazioni Confidenziali) devono intendersi riservate e non divulgabili a terzi. Le Informazioni Confidenziali potranno essere utilizzate esclusivamente nei limiti necessari per la corretta esecuzione del contratto e l'utilizzo dei Prodotti.
- 15.2 Il Compratore è responsabile verso NARDI degli eventuali danni commerciali e di immagine derivanti dal mancato rispetto delle disposizioni del presente articolo.
16. **Diritti di proprietà industriale ed intellettuale**
- 16.1 Il Compratore si impegna a non rivelare, pubblicare o divulgare, copiare, imitare, commercializzare o utilizzare in qualsiasi modo una qualsiasi parte dei brevetti e/o dei modelli e/o dei disegni e/o del know-how tecnico - commerciale di proprietà di NARDI e sarà responsabile di tutti i costi, i danni, le spese e le perdite subite da NARDI in conseguenza della violazione di questo obbligo.
- 16.2 L'utilizzo dei marchi, dell'immagine e della documentazione di NARDI, inclusi, senza pretese di esaustività, cataloghi e foto o immagini dei Prodotti (ove specificatamente autorizzati), ed i nomi commerciali dei Prodotti stessi deve essere sempre effettuato solo per la promozione dei Prodotti, nell'interesse di NARDI e in modo corretto e non ingannevole per il pubblico.
- 16.3 In particolare, tutti i diritti di utilizzo delle foto e immagini di NARDI appartengono esclusivamente a NARDI; pertanto è vietato ogni utilizzo delle medesime, in qualunque forma, senza previa espressa autorizzazione scritta di NARDI.
17. **Vendite on-line**
- 17.1 La promozione e/o la vendita dei Prodotti in internet, sui siti di e-commerce è soggetta a preventiva autorizzazione di NARDI e a relativo accordo, in quanto assoggettata a specifiche condizioni per ragioni di trasparenza verso i consumatori e a tutela dell'immagine, del marchio e della reputazione di NARDI.
- 17.2 In ogni caso:
 a) chiunque voglia vendere su proprio sito on-line i Prodotti deve avere almeno un negozio fisico con showroom, salvo diversa autorizzazione specifica di NARDI;
 b) la promozione o la vendita dei Prodotti on line su piattaforme, portali o siti non di proprietà del venditore online è vietata salvo preventiva autorizzazione scritta di NARDI;
 c) il sito di e-commerce sul quale i Prodotti vengono promossi, pubblicizzati o venduti si deve conformare alla politica di immagine di NARDI, pertanto NARDI si riserva di non autorizzare la vendita sul sito;
18. **Promozione dei Prodotti - Nomi commerciali**
- 18.1 L'utilizzo del o dei marchi di NARDI o delle foto dei Prodotti, le campagne promozionali o pubblicitarie ed in generale le modalità di promozione dei Prodotti sono soggette alla preventiva autorizzazione scritta di NARDI, sia online che offline. L'autorizzazione è sempre specifica per ed è personale per il soggetto autorizzato.
- 18.2 Chiunque venda i Prodotti sia offline che a mezzo internet:
 i. deve utilizzare i nomi commerciali di NARDI per identificare gli specifici Prodotti; e
 ii. non può cambiare il nome dei Prodotti o accostare o sovrapporre altro nome ai medesimi; e
 iii. deve precisare che il Prodotto è fabbricato da NARDI; e
 iv. deve evitare un utilizzo dei marchi e dei nomi con modalità tali da creare confusione nel pubblico circa la provenienza o la natura dei Prodotti.
- 18.3 In tutti i casi l'autorizzazione all'utilizzo dei nomi commerciali, delle immagini o foto di NARDI o il diritto di promuovere e/o vendere i prodotti online, con le modalità concordate, può essere revocata da NARDI in ogni momento con semplice comunicazione scritta, qualora NARDI ritenga che le condizioni previste nell'art. 17 o in questo articolo 18 siano state violate. In caso di revoca della autorizzazione il soggetto che riceve la revoca deve rimuovere i Prodotti e il riferimento ai marchi ed ai nomi commerciali di NARDI dal sito di e-commerce immediatamente, ed al più tardi entro 24 ore dalla revoca e cessare la relativa attività; nessuna richiesta o rimborso può essere preteso in conseguenza di tale revoca.
- 18.4 Il Compratore si impegna, anche ai sensi e agli effetti dell'art. 1381 cc, a far sì che i soggetti ai quali egli rivende i Prodotti rispettino gli articoli 17 e 18.
19. **Legge applicabile e foro competente**
- 19.1 Le presenti condizioni generali di contratto e tutti i contratti con NARDI sono disciplinati dalla legge italiana.
- 19.2 Per qualsiasi controversia relativa alla vendita dei Prodotti, e/o alle presenti Condizioni Generali di Vendita, sarà esclusivamente competente il foro della sede di NARDI.
- 19.3 Tuttavia, in deroga a quanto stabilito sopra, la sola NARDI ha comunque la facoltà di portare la controversia davanti alla autorità giudiziaria del luogo dove ha sede il Compratore.

1° Ottobre 2018

NARDI SPA – GENERAL SALES CONDITIONS B2B

1. General Information

- 1.1 All sales contracts for the Products will be subject to these General Terms and Conditions of Sale which replace any previous term and condition of sale.
- 1.2 By sending an order or accepting a quote, the Buyer accepts these General Conditions of Sale.
- 1.3 Any Buyer general purchase conditions cannot be considered applicable.
- 1.4 The Product specifications, price lists and catalogues can be modified by NARDI at any time.
- 1.5 Standard articles are only those indicated in the catalogue in force when ordering. The technical data and photographs shown in the catalogues are to be considered merely indicative.

2. Termination of the Agreement

- 2.1 Verbal or telephone orders and any changes to orders must be confirmed in writing by the Buyer and only that accepted in writing by NARDI will be binding. The order confirmations sent by NARDI, if they contain variations with respect to the order received, are considered accepted if not contested by the Buyer within three days after being sent.
- 2.2 In case of orders for customized Products, the Buyer must send the information needed to produce the Product in a clear and precise way. NARDI is not required to verify the correctness and completeness of the instructions received and will not be liable if the Buyer fails or incorrectly communicates data or information.

3. Price

- 3.1 The prices indicated in this price list are those recommended for the End User and are always VAT excluded.
- 3.2 The price for the Buyer is that which will be expressly indicated in the order confirmation sent by NARDI to the Buyer.

4. Payment

- 4.1 The Buyer must pay the price strictly according to the terms and conditions indicated in the Order Confirmation; all costs related to the payment are charged to the Buyer.
- 4.2 In the absence of any other indication, the Buyer will have to pay the full price in advance and by bank transfer. Customized supplies are always subject to the payment of a deposit against the Order and to specific payment conditions.
- 4.3 The place agreed for payment is CHIAMPPO (VI) Italy.
- 4.4 Unless otherwise agreed, transport and shipping costs, insurance of goods during transport, customs clearance of products and any other related accessory operations, customs duties and taxes are always the responsibility of the Buyer.
- 4.5 In the event of late payment of any amount due to NARDI, in addition to default interest, pursuant to Legislative Decree 231/2002 and Directive 2000/35 / EC, the Buyer must pay NARDI the reimbursement of administrative costs for credit recovery.

5. Delivery location

- 5.1. Place of delivery of the Products is the NARDI warehouse at its registered office in Chiampo, Via delle Stangà 14, Italy.
- 5.2. The terms for return (so-called INCOTERMS) only regulate the rights and obligations of the parties in relation to the shipment, but do not change the place of execution of the delivery obligation that remains the NARDI warehouse.

6. Delivery Date

- 6.1 The delivery date is ex-works and is purely indicative and not binding for NARDI. Any delays in delivery, shipping or transport will not give rise to any penalty, compensation for damages, interest charges, nor termination, even partial, of the contract, for NARDI.

7. Product packaging

- 7.1 NARDI provides packaging for delivery or shipment of the Products in the standard form, as usual for these Products, and the relative cost is included in the price. If the Buyer requests special packaging, or in NARDI's opinion it is required by the shipping method, any additional costs may be charged to the Buyer.
- 7.2 Contributions for packaging other than Italian are not included in the price and are the responsibility of the Buyer in the country of

destination, unless otherwise specified.

8. Shipment

- 8.1 In the absence of specific indications, the terms for return are understood as EX WORKS (CCI Incoterms of Paris) headquarters of NARDI Via delle Stangà 14- 36072 Chiampo (VI).
- 8.2 Whatever the terms of return agreed by the parties, NARDI frees itself from the risk at the latest when the first carrier withdraws or takes over the Products.
- 8.3 When the withdrawal of the Products is borne by the Buyer, the Buyer must comply with the protocol for the withdrawal of the Products processed by NARDI.

9. Verification obligations upon receipt of the goods

- 9.1 The Buyer must undertake to examine the Products, without delay, upon receipt.
- 9.2 Only when the goods are transported by NARDI, in the event that the Products or their packaging are damaged or in the presence of missing goods, the Buyer is required to sign the transport document or PDA with specific reservation, always indicating the reason for the reservation. A copy of this document must be sent to Nardi by e-mail within 8 days of receipt of the goods. Claims will not be handled without a copy of the transport document signed with reserve and after the aforementioned deadline. Except for damages not immediately verifiable upon receipt of the goods, which must be reported by e-mail, under penalty of forfeiture, within 8 days from receipt of the goods.
- 9.3 The Buyer must in any case verify the integrity of the items before transferring them to third parties. After transfer, any claims for damages due to transport will not be accepted.

10. Guarantee

- 10.1 NARDI undertakes, at its sole choice, to replace, repair or refund defective products, only if the defects are caused by the raw material used or the manufacture and only after having examined the defective product.
- 10.2 The guarantee, according to the terms of the law, starts from the date of the products are delivered by NARDI to the Buyer. NARDI will not accept returns or disputes after these terms or under different conditions.
- 10.3 The Products are guaranteed against manufacturing defects under normal conditions of use. As an example, no warranty applies to Products:
 - a) that have been modified or altered or tampered with in any way by any person other than NARDI or his representative;
 - b) that have been used or stored under environmental conditions other than those indicated by NARDI or in any case not suitable for the Product.
- 10.4 The guarantee does not cover parts of the Products subject to normal wear and/or deterioration or defects resulting from unsuitable transport.
- 10.5 Using the Products after discovering the defects frees NARDI from any guarantee or liability.
- 10.6 It will be the Dealer's responsibility to replace the Product for the Final User in the shortest possible time, also using goods in stock; unless otherwise agreed or the circumstances require a dedicated shipment, the replacement Product will be sent by NARDI with the first useful shipment.

11. Claims

- 11.1 Any lack of conformity, or defect of the Products, must be communicated by e-mail, under penalty of forfeiture, no later than eight days: a) from the date the Products are received by the Buyer in case of apparent defects (i.e. such that should have been discovered by a diligent Buyer); b) from the date the defects are discovered, in case of hidden defects, and in any case no later than the deadline set forth in art. 10.2, after delivering the Products to the Buyer.
- 11.2 Complaints must indicate all the information necessary to identify the problem, the quality control number (present on the packaging and on the Product), copy of the invoice or receipt with the relative

date of purchase, any photos or documentary proofs of the Complaint and the indication of the contact person.

12. **Limitation of Liability**

12.1 Except in the case of willful misconduct or gross negligence, NARDI will not be liable for damages resulting from or connected to lack of conformity of the Products or delays in delivery.

12.2 If, in any case, NARDI is responsible, the amount of compensation for defects and flaws in the Products cannot exceed the value of the Product equal to the price paid by the Buyer.

12.3 In any case, excluding the Buyer's right to terminate the contract.

13. **Retention of title**

13.1 It is agreed that the Products delivered remain the property of NARDI until the payment is received by the latter; NARDI is therefore authorized to access the premises where the Buyer retains Products to withdraw them.

14. **Failure of the Buyer**

14.1 In the event that the Buyer is at fault or there is reason to believe that he is unable to fulfil his contractual obligations on time, NARDI, at its sole discretion, may suspend the implementation of the contracts in progress until the Buyer settles any outstanding payments, depriving the Buyer of the benefits of the terms agreed to, and request the issuance of suitable bank guarantees.

15. **Confidentiality obligations**

15.1 All news relating to the know-how of which NARDI is the owner, as well as other business and commercial information revealed to the Buyer during the negotiation and execution of the contract (Confidential Information) must be considered confidential and not disclosed to third parties. Confidential Information may only be used within the limits necessary for the correct execution of the contract and use of the Products.

15.2 The Buyer is liable to NARDI for any commercial and image damage deriving from failure to comply with the provisions of this article.

16. **Industrial and intellectual property rights**

16.1 The Buyer undertakes not to reveal, publish or disclose, copy, imitate, market or use in any way any part of the patents and/or models and/or drawings and/or technical-commercial know-how owned by NARDI and will be responsible for all costs, damages, expenses and losses incurred by NARDI as a result of the violation of this obligation.

16.2 The use of NARDI trademarks, images and documentation, including, with no pretension of being exhaustive, catalogues and photos or images of the Products (unless specifically authorized), and the commercial names of the Products must always be made only for promoting the Products, in the interest of NARDI and in a correct and not misleading way for the public.

16.3 In particular, all rights to use NARDI's photos and images belong exclusively to NARDI; therefore, any use of these in any form without the prior written authorization of NARDI is prohibited.

17. **On-line sales**

17.1 The promotion and/or sale of Products on the Internet, on e-commerce sites, is subject to prior authorization from NARDI and the relative agreement, as it is subject to specific conditions for reasons of transparency towards consumers and protection of the NARDI image, brand and reputation.

17.2 In any case:

a) anyone who wants to sell the products online on their website must have at least one physical store with showroom, unless otherwise specified by NARDI;

b) the promotion or sale of the Products online on platforms, portals or sites not owned by the online seller is forbidden unless authorized beforehand in writing by NARDI;

c) the e-commerce site on which the Products are promoted, advertised or sold must conform to the NARDI image policy, therefore NARDI reserves the right not to authorize the sale on the site;

18. **Product Promotion - Commercial Names**

18.1 The use of the NARDI trademark(s) or photos of Products, promotion or advertising campaigns and in general the methods for promoting

the Products are subject to NARDI's prior written authorization, both online and offline. The authorization is always specific to and personal to the authorized subject.

18.2 Anyone who sells the Products both offline and via internet:

i. must use the NARDI trade names to identify the specific Products; and
ii. cannot change the name of the Products or approach or overlap another name to them; and

iii. must specify that the Product is manufactured by NARDI; and
iv. must avoid using trademarks and names in ways that create confusion in the public regarding the origin or nature of the Products.

18.3 In all cases the authorization to use the commercial names, images or photos of NARDI or the right to promote and/or sell the products online, in the agreed manner, can be revoked by NARDI at any time by simple written communication, if NARDI believes that the conditions set forth in art. 17 or in this article 18 have been violated. In case of revocation of the authorization the subject who receives the revocation must remove the Products and the reference to the trademarks and NARDI commercial names from the e-commerce site immediately, and at the latest within 24 hours of the revocation and cease the related activity; no request or reimbursement can be claimed as a result of such revocation.

18.4 The Buyer undertakes, also pursuant to and in accordance with art. 1381 of the Civil Code, to ensure that the subjects to whom he resells the Products comply with Articles 17 and 18.

19. **Law in force and jurisdiction**

19.1 These general contract terms and conditions and all contracts with NARDI are governed by Italian law, with the exception of the rules governing the conflict between laws of different jurisdictions. The United Nations Convention on Contracts for the International Sale of Goods (the Vienna Convention of 1980) does not apply.

19.2 Any dispute concerning the sale of Products and/or these General Conditions of Sale, will be under the jurisdiction of the competent court of the place where NARDI has its head offices.

19.3 However, notwithstanding the above, only NARDI has the right to bring the dispute before the legal authority of the place where the Buyer is located, without prejudice to the exclusive applicability of Italian law.

20. **Miscellaneous**

20.1 These general conditions of sale have been written in Italian therefore, in the event of discrepancies, the Italian version will prevail as the original text, even in the presence of translations, except for clause 19 - Applicable law and jurisdiction.

1st October 2018

NARDI s.p.a.

Chiampo (VI) Italy
tel. +39 0444 422100
info@nardioutdoor.com

www.nardioutdoor.com

P.IVA - REG.IMPRESSE VI ISO IT 02114700244
R.E.A. 207085 - Cap.Soc. 6.000.000 e int.vers.

