



Read this document carefully before using this device. The guarantee will be expired by device damages if you don't attend to the directions in the user manual. Also we don't accept any compensations for personal injury, material damage or capital disadvantages.

ENDA ECH SERIES UP/DOWN COUNTER & RPM/TACHOMETER

Thank you for choosing ENDA ECH series devices.

- ▶ 48x48mm and 72x72mm sizes.
- ▶ 2x6 digits indicator.
- ▶ Programmable as Counter and RPM/Tachometer.
- ▶ 6 Digits Batch Counter.
- ▶ 9 Digits Total Counter.
- ▶ Period time differences, pulse time, turnover and speed measurement.
- ▶ Easy to use front panel keypad.
- ▶ Counts Up or Down according to input phase difference.
- ▶ Input frequency can be selected.
- ▶ Input signal can be calibrated to the desired value by multiplying between 0.000001 and 99.9999.
- ▶ Decimal point can be set between 1 and 5.
- ▶ Sensor input type can be selected by using keypad (PNP, NPN).
- ▶ Dual setpoint and dual contact relay.
- ▶ SET1 can be selected to dependent on SET2.
- ▶ Output contact relay can be adjusted to continuous output or between 0.01 and 999.9-second intervals.
- ▶ Output delay time can be adjusted in Tachometer Mode.
- ▶ Functional reset selection.
- ▶ 0 - 500000 Offset selection.
- ▶ Parameter access protection.
- ▶ Easy installation.
- ▶ RS485 Modbus communication interface (Specify at order).
- ▶ CE marked according to European Norms.



Order Code : ECH <input type="text"/> <input type="text"/> <input type="text"/> - <input type="text"/> <input type="text"/> <input type="text"/> <input type="text"/> - <input type="text"/> <input type="text"/>		
1	2	3
1 - Size 4400.....48x48x87mm 7700.....72x72x97mm	2 - Supply Voltage 230VAC...90-250V AC 24VAC.....24V AC SM.....9-30V DC / 7-24V AC	3 - Modbus Selection RSIRS-485 Modbus Blank....N/A

TECHNICAL SPECIFICATIONS



RoHS
Compliant

ENVIRONMENTAL CONDITIONS

Ambient / Storage Temperature	0 ... +50°C/-25 ... +70°C (with no icing)
Max. relative humidity	80% Relative humidity for temperatures up to 31°C, decreasing linearly to 50% at 40°C.
Rated pollution degree	According to EN 60529 ; Front Panel : IP65, Rear Panel : IP20
Height	Max. 2000m

⚠ KEEP AWAY device from exposed to corrosive, volatile and flammable gases or liquids and DO NOT USE the device in similar hazardous locations.

ELECTRICAL CHARACTERISTICS

Supply	90-250V AC +%10 -%20, 50/60Hz, 24V AC ±%10, 50/60Hz or 9-30V DC / 7-24V AC ±%10 SMPS
Power Consumption	Max. 5VA
Wiring	Power connection : 2.5mm ² screw-terminal, Signal connection : 1,5mm ² screw-terminal connections
Data Protection	EEPROM (Min. 10 years)
EMC	EN 61326-1: 2013 (Performance criterion B satisfied for EN 61000-4-3 standard).
Safety Requirements	EN 61010-1: 2010

INPUTS

Count inputs CPA, CPB	2 Channels (Max. 50KHz, between 5V and 30V pulses). Can be selected as PNP and NPN input.
Counting frequency (Hz)	Can be programmed to 20hz, 50hz, 100Hz,500hz, 1000hz, 5000hz, 10KHz,20Khz, 30Khz and 40Khz.
Reset Input	PNP : Positive Reset (Can be adjusted between 1ms and 100ms for 5V and 30V pulses). NPN : GND terminal can be reset by connecting to "RESET IN" terminal.

OUTPUTS

Control Output (OUT1 and OUT2)	Relay : 250V AC, 8A (for resistive load), NO
SSR1 and SSR2 Output	Open collector output (S.S. OUT) : Max. 30V DC, 50mA
Sensor (Auxiliary) Supply Output	12V DC, Max. 50mA (without regulation)
Life expectancy for relay	Without load: 300.000 switching; 250V AC, 8A (resistive load) 300.000 switching.
Accuracy	± % 0.01 ± 1ms

⚠ Note : "Relay" and "S.S.OUT" outputs runs simultaneously. i.e, When "OUT1" or "OUT2" relay is operated, "SSR1" or "SSR2" transistor is activated.

HOUSING

Housing Type	Suitable for flush-panel mounting according to DIN 43 700.
Dimensions	ECH4400 : G48xY48xD87mm, ECH7700 : G72xY72xD97mm.
Weight	Approx. 230g (after packing)
Enclosure Material	Self extinguishing plastics

⚠ Avoid any liquid contact when the device is switched on. DO NOT clean the device with solvent (thinner, gasoline, acid etc.) and / or abrasive cleaning agents.



SISEL MÜHENDİSLİK ELEKTRONİK SAN. VE TİC. A.Ş.
Şerifali Mah. Barbaros Cad. No:18 Y.Dudullu 34775
ÜMRANİYE/İSTANBUL-TÜRKİYE
Tel : +90 216 499 46 64 Pbx. Fax : +90 216 365 74 01
url : www.enda.com.tr



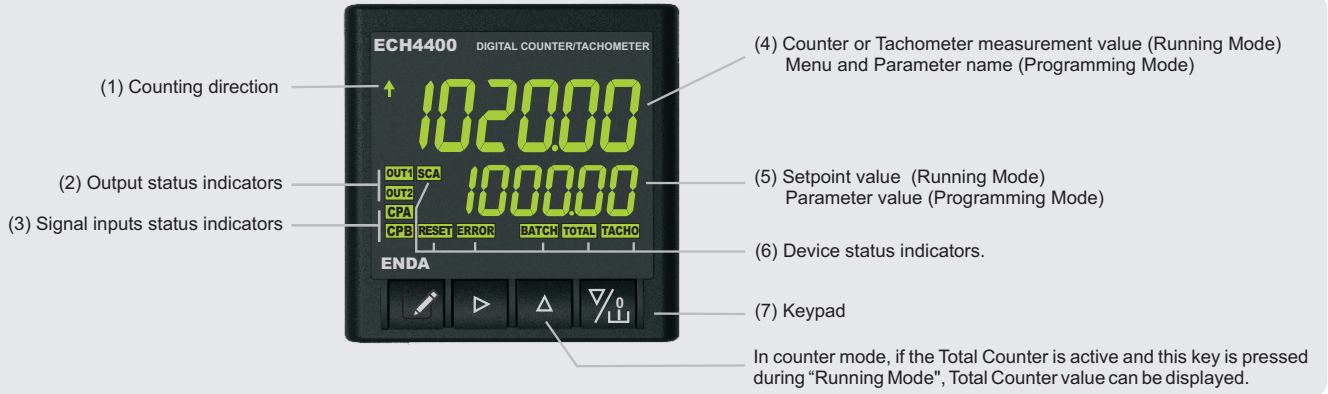

(1) Counting Direction	Up / Down arrows (same as PV indicator color)
(2) Output status indicators	Two pieces (same as SV indicator color)
(3) Signal inputs status indicators	Two pieces (same as SV indicator color)
(4) PV Indicators	7 segment, 6 digits. LCD indicator colors can be selected as red, green and orange. (Character height 10 mm).
(5) PV Indicators	7 segment, 6 digits. LCD indicator colors can be selected as red, green and orange. (Character height 7 mm).
(6) Device status indicators	Six pieces (same as SV indicator color)
(7) Keypad	Micro switch

SETTING UP PRESET VALUES



While in "Running Mode", by pressing to key, **Preset1** or **Preset2** setpoint values can be selected. Selected setpoint value displayed on the upper indicator and adjustable digit flashes. If no key is pressed for 4 seconds, "Running Mode" is entered.

PRESSED VALUES

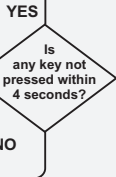
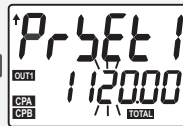
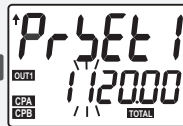
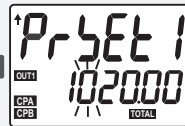
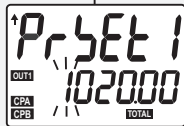

By using key, **Preset1** time is selected and by pressing key desired digit is selected. Selected digit flashes and by using keys desired value adjusted.

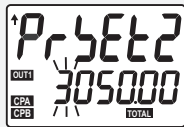

For **Preset2**, Same method is applied such as **Preset1** value settings.



If **Tacho** mode is selected and the **INPLYP** parameter is set to **ib** or **ibR**, CPA input can be monitored at the bottom display.



If **Tacho** mode is selected and the **INPLYP** parameter is set to **ib** or **ibR**, CPB input can be monitored at the bottom display.

COUNTER SETTINGS

⚠ If *dE.nodE* parameter is selected as *Counter*, following parameters will be activated.

Accessing to "Running Mode" from "Programming Mode" :

if no key is pressed within 20 seconds, during "Programming Mode", data is stored automatically and "Running Mode" is entered. Alternatively, the same function occurs first pressing key and "Programming Mode" is entered. Then keys are pressing together, data is recorded and "Running Mode" is entered.

If key is pressed while holding key, "Programming Mode" is entered.

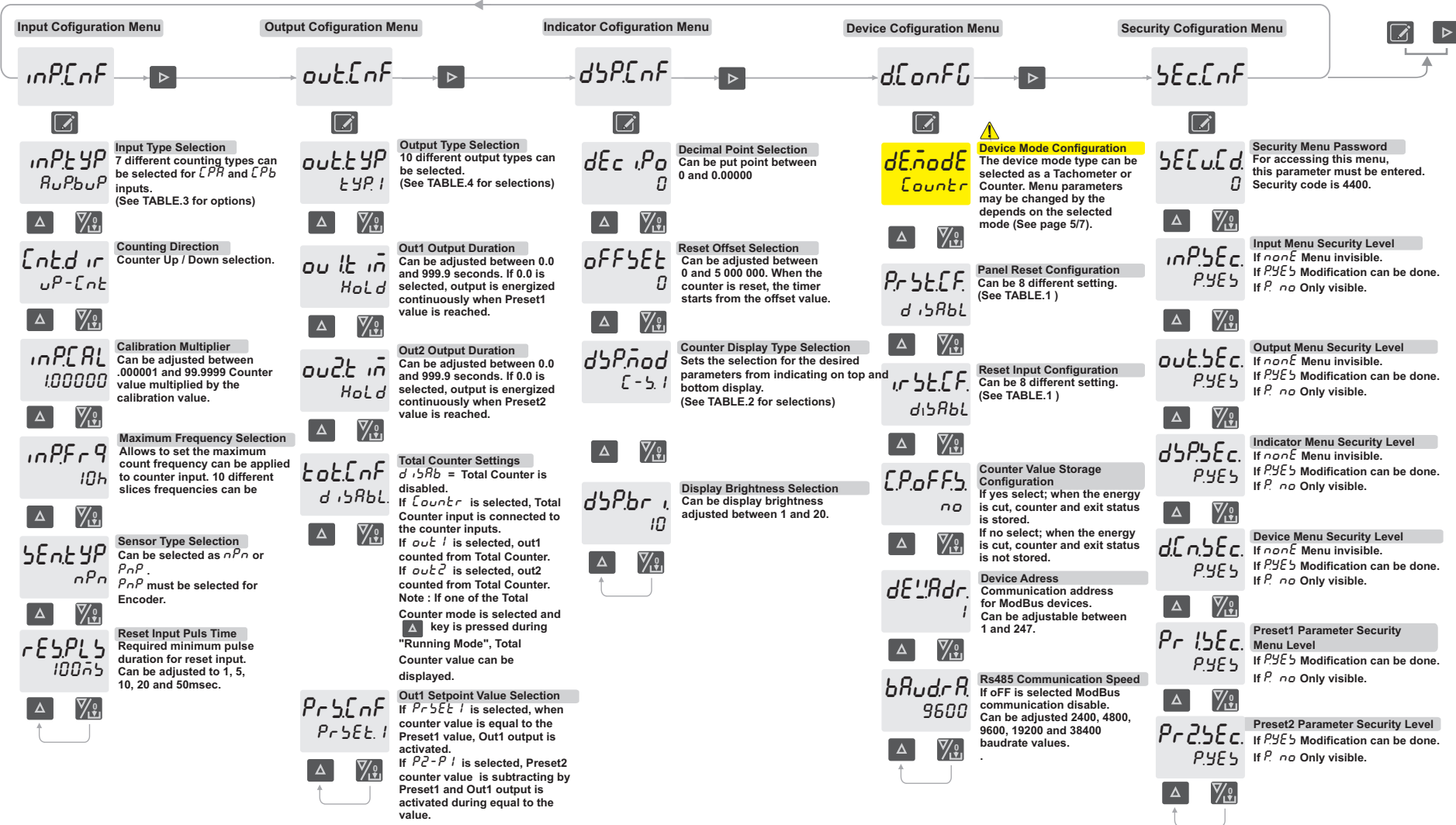

TABLE.1
Reset Configuration Table:

Pr5t.CF or %t.CF	Parameter Message	action to be taken
0	<i>d5AbL</i>	Reset is not done
1	<i>C-r</i>	Counter Reset On
2	<i>t-r</i>	Total Reset On
3	<i>b-r</i>	Batch Reset On
4	<i>Ct-r</i>	Counter and Total Reset On
5	<i>Cb-r</i>	Counter and Batch Reset On
6	<i>tb-r</i>	Total and Batch Reset On
7	<i>Ctb-r</i>	Counter, Total and Batch Reset On

TABLE.2
Parameter selection table

d5P.nod"R value	Parameter Message	UPPER Display	Lower Display
0	<i>C-5.1</i>	Counter	SET1
1	<i>C-5.2</i>	Counter	SET2
2	<i>C-b</i>	Counter	Batch
3	<i>b-5.1</i>	Batch	SET1
4	<i>b-5.2</i>	Batch	SET2
5	<i>th-tL</i>	Total H	Total L

Attention !!
 * If Batch counter mode is not selected, mode 2, mode 3 and mode 4 can not be selected
 * If the Total Counter is disabled, mode 5 can not be selected.
 * If one of the Total Counter mode is selected and mode 5 is not selected, by pressing key during "Running Mode", Total Counter value can be displayed.
 * While Total Counter displayed, by pressing key, Total Counter value can be reset.

PARAMETER SETTINGS



The selected parameter of the digit will flash when the key is pressed. Value can be changed by using navigation keys. The next digit can be selected with the key and the same method can be applied as the previous step. If the decimal point of the selected parameter can also be adjusted, the message *-dP* appears on the display during the digit selection. While this message is displayed, the decimal point is brought to the desired place with the keys. If the key (Up) is pressed continuously for 0.6 seconds, the value to be increasing rapidly. The same method applies to the decrement (Down) key.



TABLE.3

COUNTER INPUT TYPE TABLE

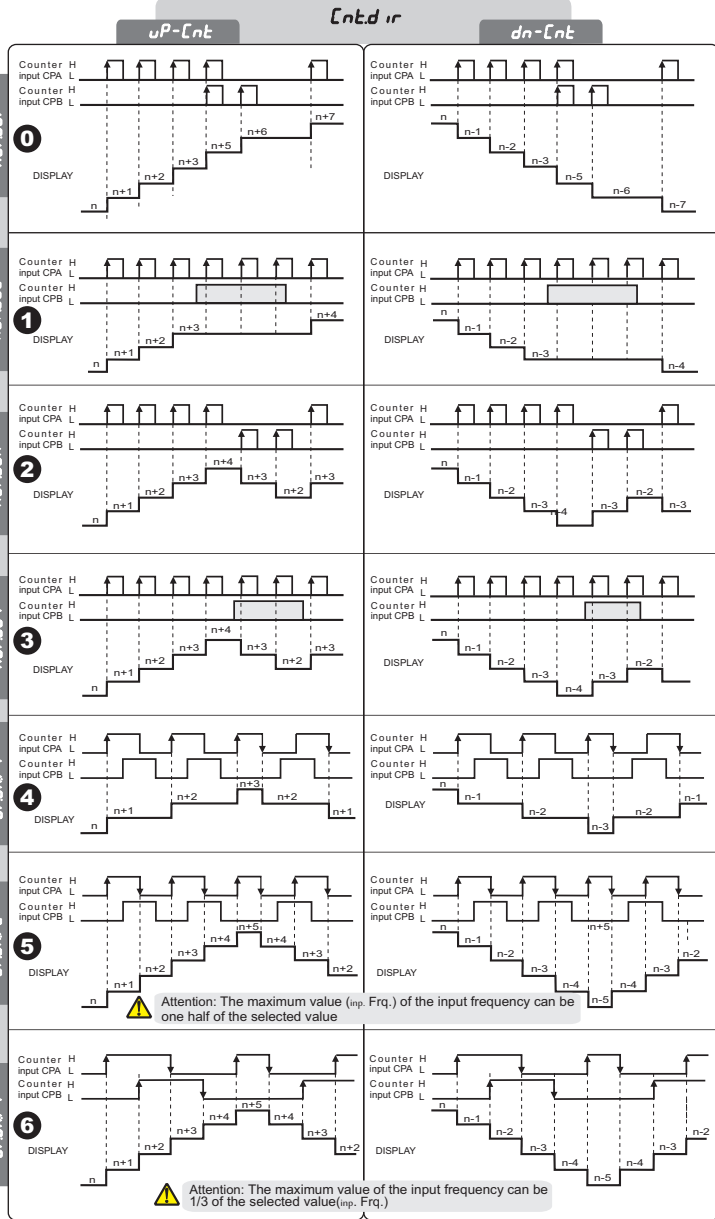

NOTE: 1

INPUT TYPE

Input Symbol	NPN input (Voltage input no)	PNP input (Voltage input)
H	input short circuit	4,5V - 30V DC
L	input open circuited	0V - 2V DC



Input frequency must not exceed the specified value. If input frequency exceed the specified value, the device does not make accurate count.

TABLE.4

COUNTER OUT TYPE TABLE

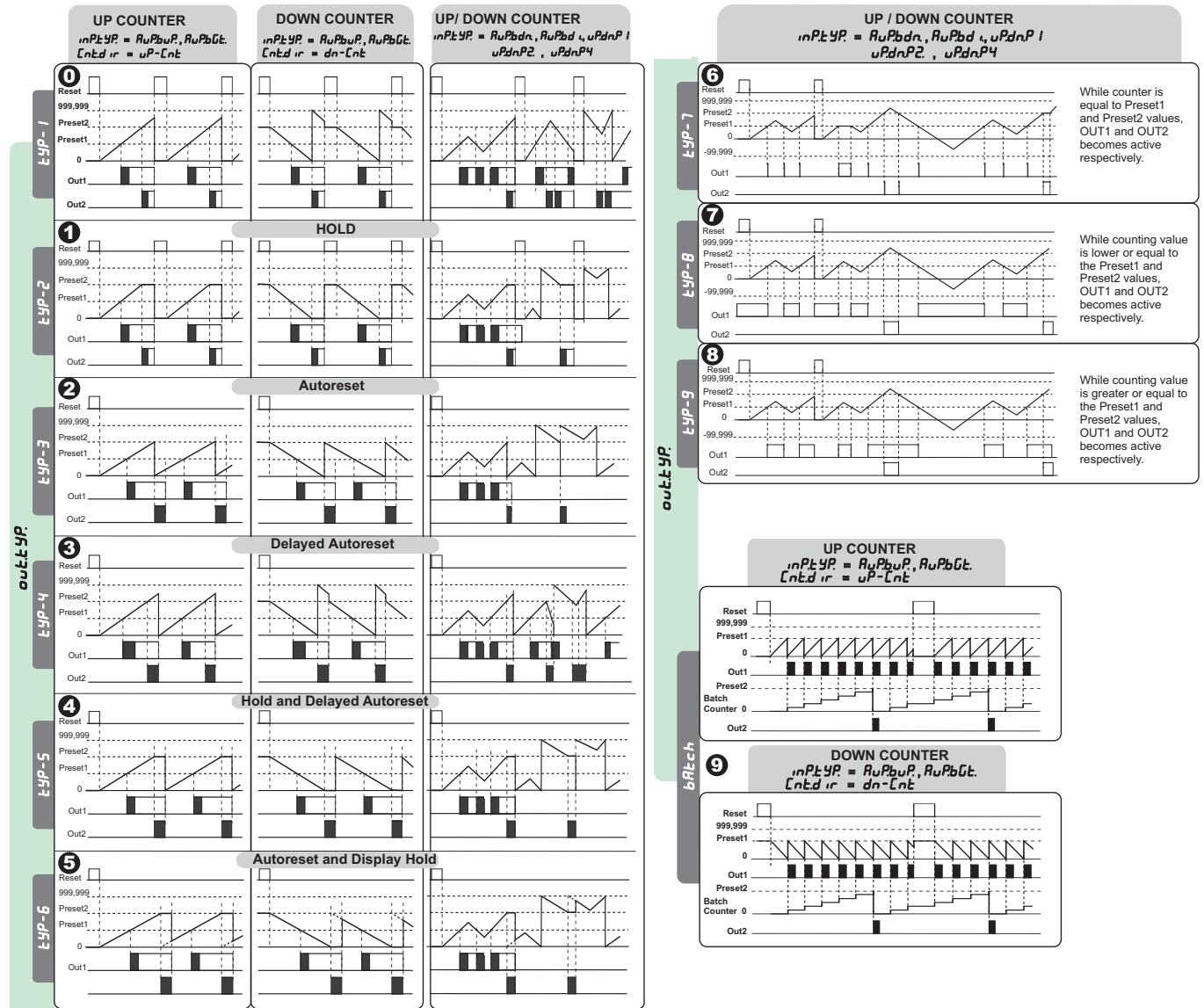

While *batch* counter mode is selected, decimal point is invisible.

Because, *PrsEt2* and *brtCh* values are integer.

■ If *ouIt n̄* and *ou2t n̄* is adjusted between 0.01 and 999.9 sec. pulse output is obtained

□ If *ouIt n̄* and *ou2t* is adjusted between 0.0 and 999.9 sec. continuous output is obtained.



REV/SPEED MEASURING MODE PROGRAMMING DIAGRAM

⚠ If $dE\dot{n}odE$ parameter is selected as $tRcha$ following parameters will be activated.

If **[Enter]** key is pressed while holding **[Right]** key, "Programming Mode" is entered.

Accessing to "Running Mode" from "Programming Mode":

If no key is pressed within 20 seconds, during "Programming Mode", data is stored automatically and "Running Mode" is entered. Alternatively, the same function occurs first pressing **[Enter]** key and "Programming Mode" is entered. Then **[Enter]** **[Right]** keys are pressing together, data is recorded and "Running Mode" is entered.

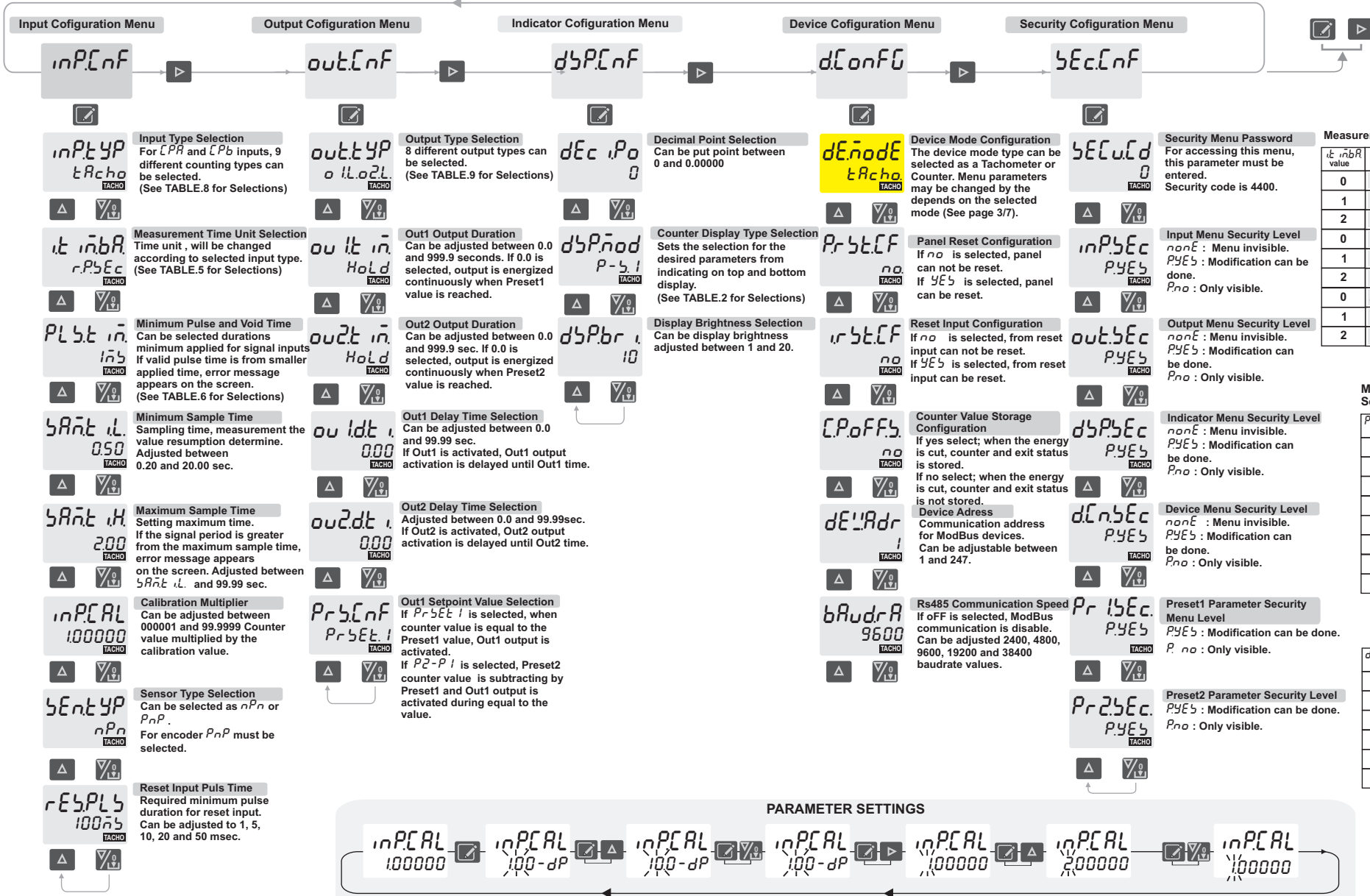

TABLE.5
Measurement Time Unit Selection Table

$tRchn$ value	Parameter message	Explanation	$inPtYP$
0	rP5Ec	Puls in 1 second	tRchn
1	rPn in	Puls in 1 minute	tL2rR
2	rPhour	Puls in 1 hour	tL2
0	nP5Ec	meter / second	L in5Pd
1	nPn in	meter / minute	
2	nPhour	metre / hour	
0	n1c5Ec	microseconds	PER iod
1	nL5Ec	milliseconds	tR in t
2	100n5	100 milliseconds	PLst in

TABLE.6
Minimum Pulse Void Time Selection Table

PLst in value	Parameter message	Explanation
0	40n5	40 msec
1	20n5	20 msec
2	10n5	10 msec
3	1n5	1 msec
4	0.5n5	0.5 msec
5	0.1n5	0.1 msec
6	0.05n5	0.05 msec
7	0.02n5	0.01 msec

TABLE.7
Parameter Selection Table to Display

$dsPnod$ value	Parameter message	UPPER Display	LOWER Display
0	P-5.1	Measuring	SET1
1	P-5.2	Measuring	SET2
2	P-R5.1	Measuring	On SET1
3	P-tP	Measuring	Total Rev
4			
5			

The selected parameter of the digit will flash when the **[Enter]** key is pressed. Value can be changed by using **[Up]** **[Down]** navigation keys. The next digit can be selected with the **[Right]** key and the same method can be applied as the previous step. If the decimal point of the selected parameter can also be adjusted, the message $-dP$ appears on the display during the digit selection. While this message is displayed, the decimal point is brought to the desired place with the **[Up]** **[Down]** keys. If the **[Up]** key (Up) is pressed continuously for 0.6 seconds, the value to be increasing rapidly. The same method applies to the decrement (Down) key.



TABLE.8 PULSE MEASUREMENT INPUT TYPE TABLE

TABLE.9 PULSE MEASURED OUTPUTS TYPE TABLE

<p>0 Pulse Measurement Method (rps: pulse/second, rpm: pulse/minute, rph : pulse/hour)</p> <p>CPA input second</p> <p>CPB(HOLD)input second</p> <p>Process value: Previous value, (Calibration/T1x60) rpm, (Calibration/T2x60) rpm, (Calibration/T2x60) rpm</p> <p>Attention: Pulse and void times input signal appropriate must be selected.</p>	<p>1 Phase Difference Input Pulse Measurement Method (rps: pulse/second, rpm: pulse/minute, rph : pulse/hour) Direction Indicator</p> <p>CPA Input second</p> <p>CPB Input second</p> <p>Process value: Previous value, (Calibration/T1x60) rpm, (Calibration/T2x60) rpm, (Calibration/T3x60) rpm</p> <p>Attention: Pulse and void times input signal appropriate must be selected.</p>								
		<p>2 CPA With CPB Inputs Puls Rate Finding Method</p> <p>CPA input second</p> <p>CPB input second</p> <p>Process value: Previous value, (1/Ta) / (1/Tb)</p>	<p>3 Speed Measurement Method (m/s : meter / second, m/m : meter / minute, m/h : meter / hour) Can Be Selected</p> <p>CPA input second</p> <p>CPB input second</p> <p>Process value: Previous value, (Calibration value / T1)m/s, (Calibration value / T2)m/s, (Calibration value / T3)m/s</p> <p>Attention: Pulse and void times input signal appropriate must be selected.</p>						
				<p>4 Period Measurement Method</p> <p>CPA input second</p> <p>CPB(HOLD)input second</p> <p>Process value: Previous value, (T1+T2+ +Tn)/n</p> <p>Attention: Pulse and void times input signal appropriate must be selected.</p>	<p>5 Time Difference Measurement Method</p> <p>CPA input second</p> <p>CPB input second</p> <p>Process value: Önceki değer, T1, T2, T3</p> <p>Attention: Pulse and void times input signal appropriate must be selected.</p>				
						<p>6 Puls Width Measurement Value</p> <p>CPA input second</p> <p>CPB(HOLD) input second</p> <p>Process Value: Previous value, T1, T2, T4</p> <p>Attention: Pulse and void times input signal appropriate must be selected.</p>	<p>7 Pulse Census Method</p> <p>CPA input second</p> <p>CPB input second</p> <p>RESET IN input second</p> <p>Process value: Previous value, counting value: 9, sayma değeri: 10, SIFIR</p> <p>Attention: Pulse and void times input signal appropriate must be selected. (Counting values Calibration = for 1)</p>		
								<p>8 Pulse Census Method</p> <p>CPA input second</p> <p>CPB input second</p> <p>RESET IN input second</p> <p>Process value: Previous value, counting value: 9, counting value: 13, ZERO</p> <p>Attention: Pulse and void times input signal appropriate must be selected. (Counting values Calibration = for 1)</p>	<p>9 CHA with CHB Inputs Pulse Difference Finding Method</p> <p>CPA input second</p> <p>CPB input second</p> <p>Process value: Previous value, ((1/Ta) - (1/Tb))x60 rpm, ((1/Ta) - (1/Tb))x60 rpm, ((1/Ta) - (1/Tb))x60 rpm</p> <p>ATTENTION ! If this method selected, measured pulse from CPA input must be greater or equal from CPB inputs pulse If CPA small CPB; <i>inPULB</i> this error message is visible. H, iGh</p>

<p>0 </p> <p>1 </p> <p>2 </p> <p>3 </p>	<p>4 </p> <p>5 </p> <p>6 </p> <p>7 </p>		
		<p>0 </p> <p>999,999</p> <p>Preset2</p> <p>Preset1</p> <p>0</p> <p>Rotate way Next Back</p>	<p>4 </p> <p>5 </p> <p>6 </p> <p>7 </p>

! If *inPULYP = tRcd ir.* is selected, following output types will be activated.

NOTE: 1

	INPUT TYPE	
Input Symbol	NPN input (Voltage input not)	PNP input (Voltage input)
H	Input shourchange	4,5V - 30V DC
L	Input open circuit	0V - 2V DC

■ If *ou1t in* and *ou2t in* is adjusted between 0.01 and 999.9 sec. pulse output is obtained.

□ If *ou1t in* and *ou2t in* is adjusted between 0.0 sec. (Hold) continuous output is obtained.

ou1dt i and *ou2dt i* is adjusted between 0.0 and 999.9 sec. Output delayed of until adjusted time . When set 0 output is instantly taken

CONNECTION DIAGRAM

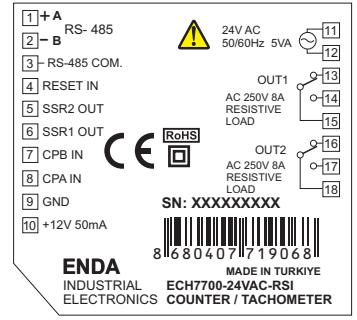
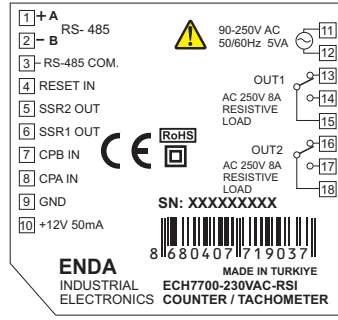
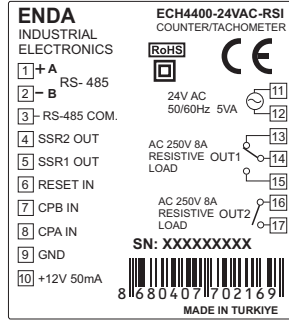
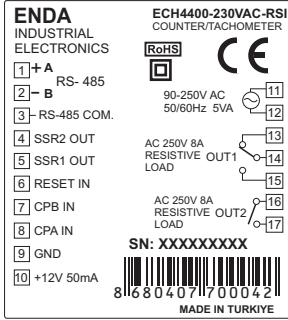

SENSOR CONNECTION SAMPLES

Connection samples for PNP sensor type

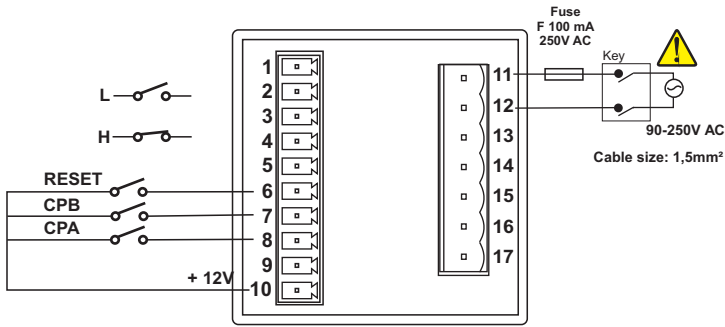

Connection samples for NPN sensor type

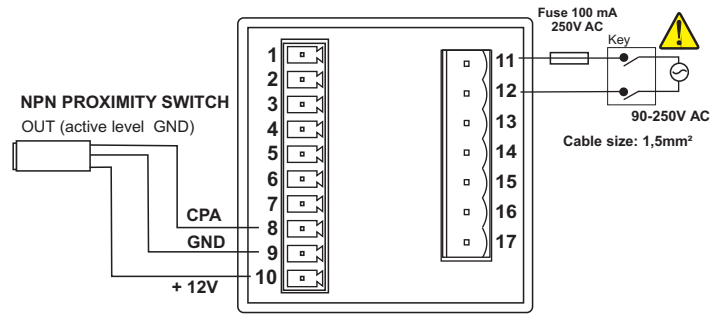
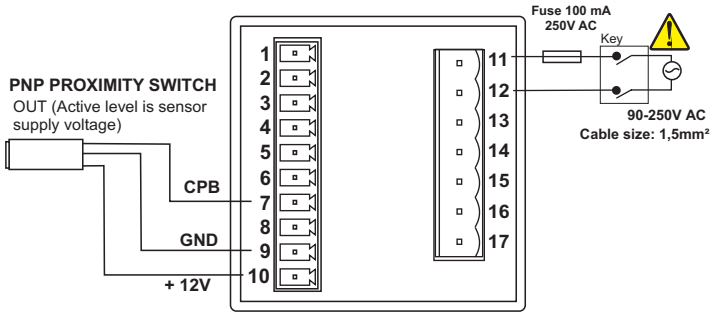
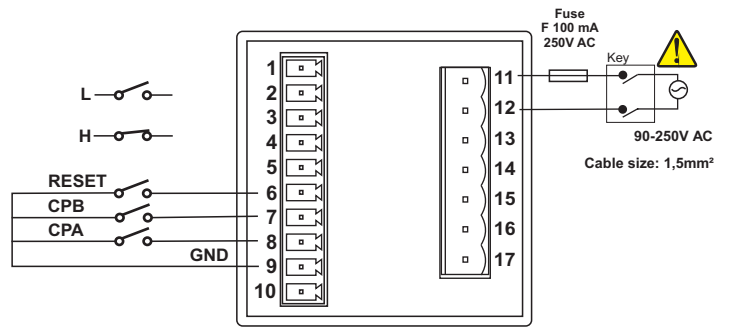

! Logic output of the device is not electrically isolated.

- Note :**
- 1) Mains supply cords shall meet the requirements of IEC60227 or IEC60245.
 - 2) In accordance with the safety regulations, the power supply switch shall bring the identification of the relevant instrument and it should be easily accessible by the operator.

Holding screw 0.4-0.5Nm

Equipment is protected throughout by DOUBLE INSULATION.

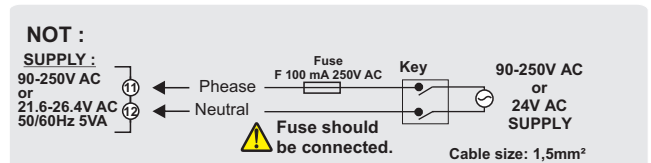

Order Code : ECH -

1 - Size	2 - Supply Voltage	3 - Modbus Selection
4400.....48x48x87mm 7700.....72x72x97mm	230VAC...90-250V AC 24VAC.....24V AC SM.....9-30V DC / 7-24V AC	RSIRS-485 Modbus Blank.....N/A

DIMENSIONS

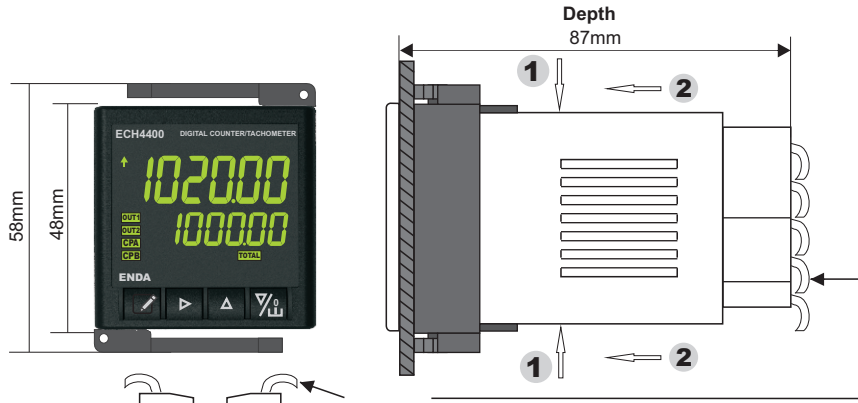

To removing the device from the panel:
 - While pressing both side of the device in direction **1** and push it in direction **2**.

NOTE:

- 1) While performing panel mounting, additional space should be allocated for cables.
- 2) Panel thickness should be maximum **9mm**.
- 3) If there is no **100mm** free space at back side of the device, it would be difficult to remove it from the panel.

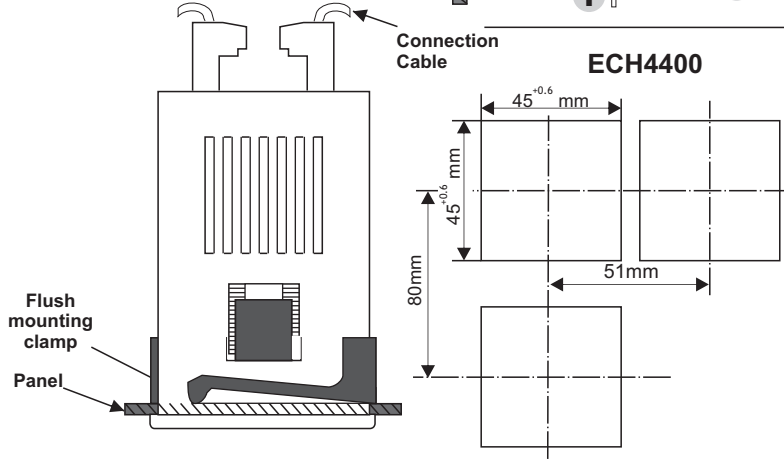

ENDA ECH Series are intended for installation within control panels. Make sure that the device is used only for intended purpose. The shielding must be grounded on the instrument side. During an installation, all of the cables that are connected to the device must be free of electrical power. The device must be protected against inadmissible humidity, vibrations, severe soiling. Make sure that the operation temperature is not exceeded. All input and output lines that are not connected to the supply network must be laid out as shielded and twisted cables. These cables should not be close to the power cables or components. The installation and electrical connections must be carried out by a qualified staff and must be according to the relevant locally applicable regulations.

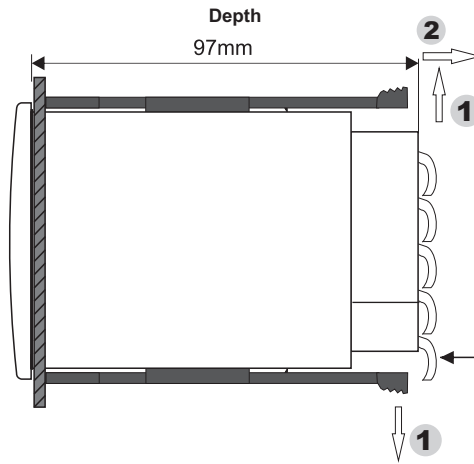

To removing the device from the panel:
 - While pressing both side of the device in direction **1** and push it in direction **2**.

NOTE:

- 1) While performing panel mounting, additional space should be allocated for cables.
- 2) Panel thickness should be maximum **9mm**.
- 3) If there is no **100mm** free space at back side of the device, it would be difficult to remove it from the panel.

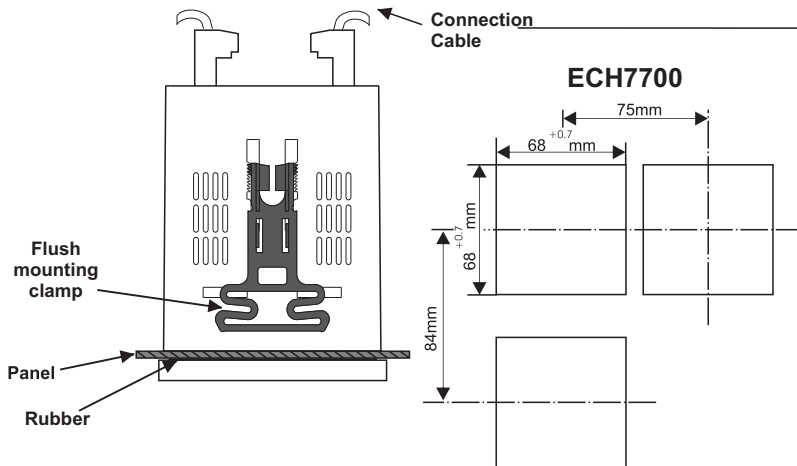

ENDA ECHxx00 COUNTER/TACHOMETER MODBUS ADDRESS MAP

1.1 Counter/Tachometer Memory Map for Timer Holding Registers

Parameter Number	Holding Register Address Decimal (Hex)	Data Type	Data Content	Read /Write	Factory Settings		
				Permissions			
Counter/Tachometer Configuration Parameters	H0	0000d (0000h)	Dword	Setpoint for Preset1 value. (Adjustable between 0-999999d. Format :32 Bit Hex = 0-999999d) First word LSW, second word MSW Sample: Adjusting for 550000d (86470h); LSW = 6470h, MSW = 0008h	R W	100000	
	H2	0002d (0002h)	Dword	Setpoint for Preset2 value. (Format must be as in the H0 parameter)	R W	200000	
	H4	0004d (0004h)	Word	Counter input type selection. (See TABLE.3 for adjustment)	R W	0	
	H5	0005d (0005h)	Word	Counter input frequency selection. 0 = 20Hz, 1 = 50Hz, 2 = 100Hz, 3 = 500Hz, 4 = 1000Hz, 5 = 5Khz 6 = 10Khz, 7 = 20Khz, 8 = 50Khz, 9 = 80Khz	R W	0	
	H6	0006d (0006h)	Word	Counter counting direction selection. 0 = Up counting, 1 = Down counting	R W	0	
	H7	0007d (0007h)	Word	Sensor type selection. 0 = NPN, 1 = PNP	R W	0	
	H8	0008d (0008h)	Word	Reset input pulse time selection. 0 = 1ms, 1 = 5ms, 2 = 20ms, 3 = 50ms, 4 = 100ms	R W	0	
	H9	0009d (0009h)	Dword	Setpoint for Calibration. (Adjustable between Format :32 Bit BCD = 1-999999) First word LSW second word MSW Sample: Adjustable between 150000 BCD (0150000h); LSW = 0000h, MSW = 0150h	R W	100000	
	H11	0011d (000Bh)	Word	Decimal point selection for Calibration. (0 = .000000, 1 = 0.00000, 2 = 00.0000)	R W	1	
	H12	0012d (000Ch)	Word	Tachometer input type selection. (See TABLE.8 for adjustment)	R W	0	
	H13	0013d (000Dh)	Word	Tachometer time base selection. (See TABLE.5 for setting)	R W	0	
	H14	0014d (000Eh)	Word	Tachometer pulse time selection. (See TABLE.6 for adjustment)	R W	3	
	H15	0015d (000Fh)	Word	Tachometer sampling time selection. Selectable between 0.20 s with 20.0 s.	R W	50	
	H16	0016d (0010h)	Word	Tachometer maximum sample time selection. Selectable between H8 and 99.99 s	R W	200	
	H17	0017d (0011h)	Word	Counter output type selection. (See TABLE.4 for adjustment)	R W	0	
	Output Parameters	H18	0018d (0012h)	Word	Total Counter configuration selection. 0 = Total Counter disable, 1 = Counter input connects: Total Counter 2 = OUT1 output connects: Total Counter, 3 = OUT2 output connects: Total Counter	R W	0
		H19	0019d (0013h)	Word	Setpoint value selection for OUT1 0 = Preset1 OUT1 output value, 1 = Preset2 - Preset1 OUT1 output value	R W	0
H20		0020d (0014h)	Word	OUT1 output time setting. Adjustable between 0.0 and 999.9 sec. 0= continuously activated	R W	0	
H21		0021d (0015h)	Word	OUT2 output time setting. Adjustable between 0.0 and 999.9 sec. 0= continuously activated	R W	0	
H22		0022d (0016h)	Word	Tachometer output type select (See TABLE.9 for adjusment)	R W	0	
H23		0023d (0017h)	Word	Tachometer OUT1 output delay time. Adjustable between 0.0 and 999.9 sec.	R W	0	
H24		0024d (0018h)	Word	Tachometer OUT2 output delay time. Adjustable between 0.0 and 999.9 sec.		0	
Display Configuration Parameters		H25	0025d (0019h)	Dword	Decimal point selection parameter. 0 = Decimal point no, 1 = 0.0 , 2 = 0.00 , 3 = 0.000, 4 = 0.0000, 5 = 0.00000	R W	10
		H27	0027d (001Bh)	Word	Offset value (Format must be as in the H0 parameter)	R W	0
		H28	0028d (001Ch)	Word	Counter display configuration selection. (See TABLE.2 for adjustment)	R W	0
	H29	0029d (001Dh)	Word	Tachometer display configuration selection. (Seen TABLE.7 for adjustment)	R W	0	
	H30	0030d (001Eh)	Word	Display brightness setting parameter. Adjustable between 1 and 20 .	R W	10	
	H31	0031d (001Fh)	Word	Counter/Tachometer selection parameter. (0 = Counter mode, 1 = Tachometer mode).	R W	0	
	H32	0032d (0020h)	Word	Counter panel reset configuration selection. (See TABLE.1 for adjusment)	R W	0	
	H33	0033d (0021h)	Word	Counter reset input configuration selection. (See TABLE.1 for adjusment)	R W	0	
	H34	0034d (0022h)	Word	Tachometer panel reset configuration selection. (0 = No, 1 = Yes)	R W	0	
	H35	0035d (0023h)	Word	Tachometer reset input configuration selection. (0 = No, 1 = Yes)	R W	0	
Device Configuration	H36	0036d (0024h)	Word	When the energy is cut, measurement value stored. (0 = No, 1 = Yes)	R W	0	
	H37	0037d (0025h)	Word	Device address value for Modbus (Adjustable between 1 and 247)	R W	1	
	H38	0038d (0026h)	Word	Connection speed for Modbus: 0 = 1200 bps, 1 = 2400 bps, 2 = 4800 bps, 3 = 9600 bps, 4 = 14400 bps, 5 = 19200 bps, 6 = 38400 bps, 7 = 57600 bps	R W	3	
	H39	0039d (0027h)	Word	Counter/Tachometer configuration menu security parameter. Adjustable between 0 and 2. 0 = Menu invisible, 1 = Menu parameters is programmable, 2 = Menu parameters is only visible	R W	1	
	H40	0040d (0028h)	Word	Output parameters menu security parameter. Adjustable between 0 and 2 0 = Menu invisible, 1 = Menu parameters is programmable, 2 = Menu parameters is only visible	R W	1	
	H41	0041d (0029h)	Word	Display configuration menu security parameter. Adjustable between 0 and 2 0 = Menu invisible, 1 = Menu parameters is programmable, 2 = Menu parameters is only visible	R W	1	
	H42	0042d (002Ah)	Word	Device configuration menu security parameter. Adjustable between 0 and 2 0 = Menu invisible, 1 = Menu parameters is programmable, 2 = Menu parameters is only visible	R W	1	
	H43	0043d (002Bh)	Word	Preset 1 (H0) parameter security parameter. Adjustable between 1 and 2 1 = Menu parameters is programmable, 2 = Menu parameters is only visible	R W	1	
	H44	0044d (002Ch)	Word	Preset 2 (H2) parameter security parameter. Adjustable between 1 and 2 1 = Menu parameters is programmable, 2 = Menu parameter is only visible	R W	1	
	H45	0045d (002Dh)	Word	Function control parameter If (23040d (5A00h) value is entered, device is returned to factory settings. If 23041d (5A01h) value is entered, must be reset according to H33 value. If 23042d (5A02h) value is entered, counting value is reset. If 23043d (5A03d) value is entered, Total Counter reset If 23044d (5A04h) value is entered, Batch counter reset If 23045d (5A05h) value is entered, Tachometer values is reset	R W	0	

ENDA ECHxx00 COUNTER/TACHOMETER MODBUS ADDRESS MAP

1.2 Memory Map For Input Registers

Parameter Number	Input Register address Decimal (Hex)	Data Type	Data Content	Read / Write Permission
I0	0000d (0000h)	Dword	Counter counting values (Format :32 Bit Hex = Adjustable between -999999 and 999999d) First word LSW, second word MSW Sample: Reading value for 550000d (86470h); LSW = 6470h, MSW = 0008h.	R
I2	0002d (0002h)	Dword	Batch counter counting value (Format :32 Bit Hex = Adjustable 0 and 999999d) First word LSW, second word MSW Sample: If reading value is 550000d (86470h) ; LSW = 6470h, MSW = 0008h	R
I4	0004d (0004h)	Dword	Total Counter counting value (Format :32 Bit Hex = Adjustable between -999,999,999 and 999,999,999d) First word LSW, second word MSW	R
I6	0006d (0006h)	Dword	Counter hold value (Format is as in the I0 input register)	R
I8	0008d (0008h)	Dword	Active Preset1 value (Format is as in the I2 input register)	R
I10	0010d (000Ah)	Dword	Tachometer measurement value (Format is as in the I2 input register)	R
I12	0012d (000Ch)	Dword	CPA pulse value (Format is as in the I2 input register)	R
I14	0014d (000Eh)	Dword	CPB pulse value (Format is as in the I2 input register)	R

1.3 Memory Map for Input Registerlers

Parameter Number	Holding Register addresses Decimal (Hex)	Data Type	Data Content	Read / Write Permission
I0	0000d (0000h)	Word	Timer1 time value (Must be read according to BCD format)	R
I1	0001d (0001h)	Word	Timer2 time value (Format is as in the I0 parameter)	R
I2	0002d (0002h)	Word	Out1 pulse time value (Must be read according to BCD format. Sensitivity 0.00sn)	R
I3	0003d (0003h)	Word	Out2 pulse time value (Format is as in the I2 parameter)	R

1.4 Memory Map for Output Status Indicator Bits

Parameter Number	Discrete input addresses	Data Type	Data Content	Read / Write Permission
D0	(0000)h	Bit	OUT1 Output status (0 = OFF ,1 = ON)	R
D1	(0001)h	Bit	OUT2 Output status (0 = OFF , 1 = ON)	R
D2	(0002)h	Bit	Panel reset key status (0 = Reset key inactive, 1 = Reset key is active)	R
D3	(0003)h	Bit	Reserve	R
D4	(0004)h	Bit	Reset input status (0 = Reset input inactive, 1 = Reset input is active)	R
D5	(0005)h	Bit	Gate input status (0 = Gate input inactive, 1 = Gate input is active)	R
D6	(0006)h	Bit	Start input status (0 = Start input inactive, 1 = Start input is active)	R
D7-D15	0007d (0007h) 0015d (000Fh)	Bit	Reserve	R

1.5 Memory Map for Software Revision Input Registers

Software Revision	0920d (0398h)	14 Word	Software name and update date is in ASCII format and 14 word. Example : EM4400-01 28 Feb 2015. Memory Format : Word Word Word Word Word Word Word Word Word Word Word Word Word Word Word 1 2 3 4 5 6 7 8 9 10 11 12 13 14 C E 4 4 0 0 0 - 1 4 2 A g u 2 1 0 . 6	R
NOTE : To view each word correctly by changing the byte sequences should be displayed as ASCII TEXT				

2. MODBUS ERROR MESSAGES

Modbus protocol has two types error, communication error and operating error. Reason of the communication error is data corruption in transmission. Parity and CRC control should be done to prevent communication error. Receiver side checks parity and CRC of the data. If they are wrong, the message will be ignored. If format of the data is true but function doesn't perform for any reason, operating error occurs. Slave realizes error and sends error message. Most significant bit of function is changed '1' to indicate error in error message by slave. Error code is sent in data section. Master realizes error type via this message.

ModBus Error Codes

Error Code	Name	Meaning
01	ILLEGAL FUNCTION	The function code received in the query is not an allowable action for the slave. If a Poll Program Complete command was issued, this code indicates that no program function preceded it.
02	ILLEGAL DATA ADDRESS	The data address received in the query is not an allowable address for the slave.
03	ILLEGAL DATA VALUE	A value contained in the query data field is not an allowable value for the slave.

Message example;

Structure of command message (Byte Format)

Device Address		(0A)h
Function Code		(01)h
Beginning address of coils.	MSB	(04)h
	LSB	(A1)h
Number of coils (N)	MSB	(00)h
	LSB	(01)h
CRC DATA	LSB	(AC)h
	MSB	(63)h

Structure of response message (Byte Format)

Device Address		(0A)h
Function Code		(81)h
Error Code		(02)h
CRC DATA	LSB	(B0)h
	MSB	(53)h

As you see in command message, coil information of (4A1)h = 1185 is required but there isn't any coil with 1185 address. Therefore error code with number (02) (Illegal Data Address) sends.

