

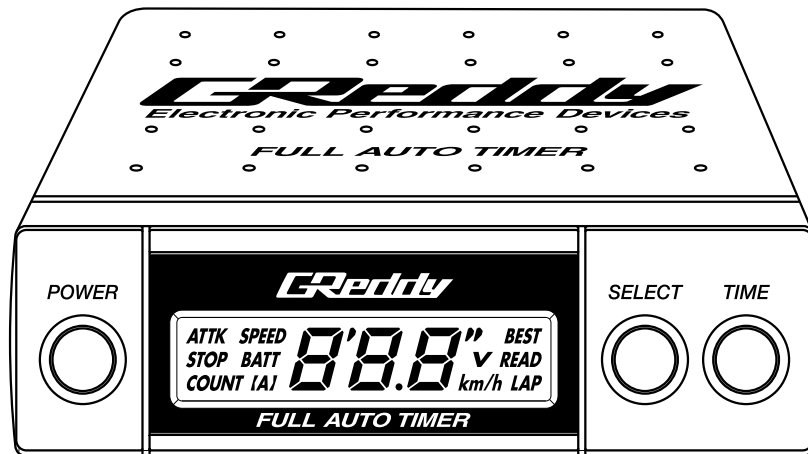

Take it easy!

GReddy **FULL AUTO TIMER**

Instruction Manual



GReddy

Parts List

Important

Please check the list below to make sure you have all of the following parts before you proceed. If you are missing parts please contact the GReddy Authorized Dealer you purchased the unit from.

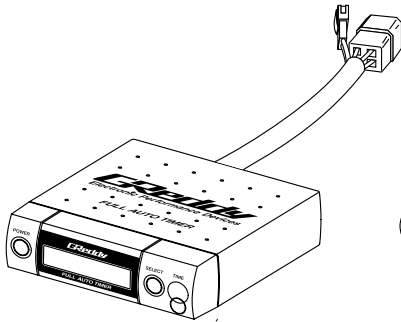

Turbo Timer
1pc.

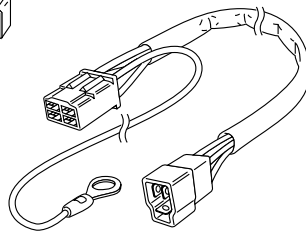

Main Harness
1pc.

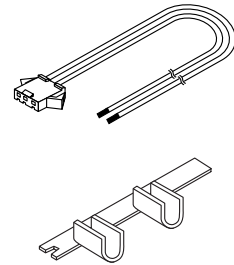

Power Harness
1pc.

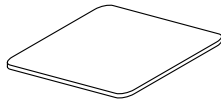

Double-sided Tape
1 set

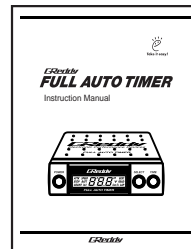

Instruction Manual
1pc.

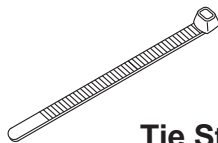

Tie Strap
3 pcs.

Minimum Tools Required	Tools for a Professional Installation
<ul style="list-style-type: none"> * Pliers * Dikes * Phillips and Flat Screw drivers * 10mm Wrench * Wire Tester (15V-min) 	<ul style="list-style-type: none"> * Soldering Iron & Solder * Drill and Drill Bits * Electrical Tape * Wire Connectors

Installation (using Optional Turbo Timer Harness)

- (1) Follow the key switch to it's electrical connector, then unplug the harness and place the Optional Turbo Timer harness in-line with the key switch harness.
- (2) Connect the supplied power harness in between the 3-pin connector of the optional harness and the 4-pin connector of the Turbo Timer.
- (3) Then connect the black wire with the loop connector to a good chassis ground.(to steel body)

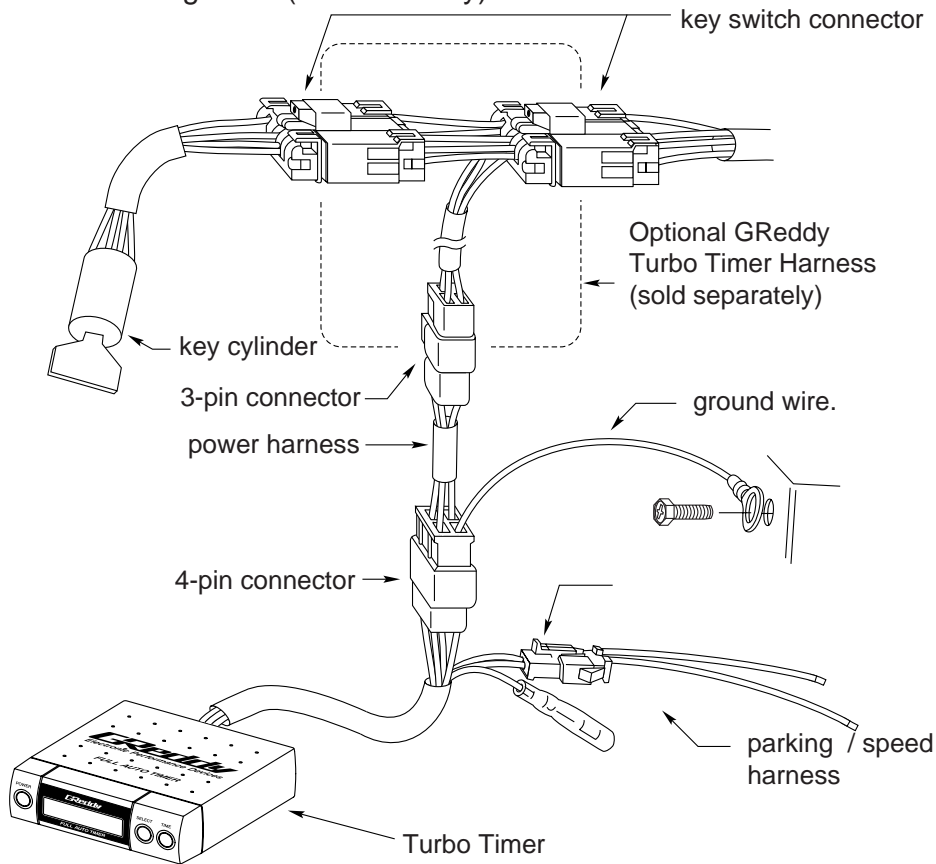

Important!

A bad ground connection can lead to a mechanical failure, therefore please attach the ground to a non-painted surface of the vehicles steel body.

Installation (without Optional Turbo Timer Harness)

- (1) Follow the key switch to it's electrical connector, then unplug the harness. Find the appropriate wires with either a factory service manual or a volt meter. (see 2.3 for wiring)
- (2) Cut off the 3-pin connector on power harness. Then splice and solder the appropriate wires to the power harness. (be sure to cover connections)
- (3) Then connect the black wire with the loop connector to a good chassis ground.(to steel body)
- (4) Reconnect the key switch harness.

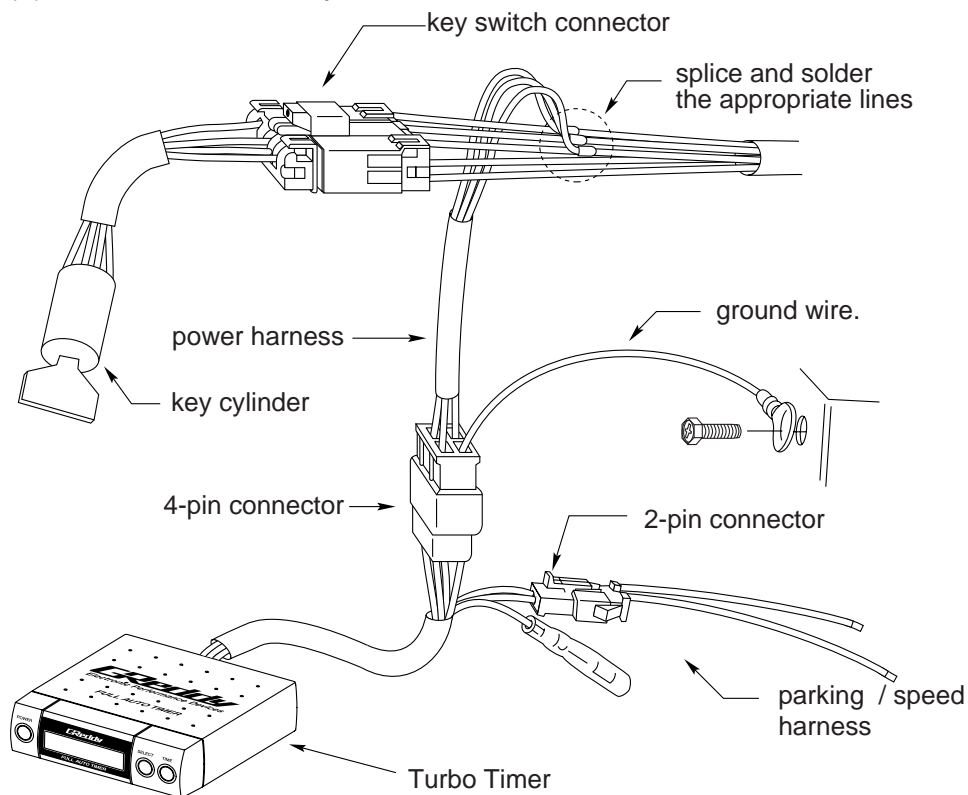

Important!

A bad ground connection can lead to a mechanical failure, therefore please attach the ground to a non-painted surface of the vehicles steel body.

Wiring Diagram

The wires coming out from the key switch usually consist of:

12 v - 12 volt constant power

ON - Ignition power

ACC - Accessory power

ST - Starter signal

Other than these four wires, the vehicle may have two ON wires.

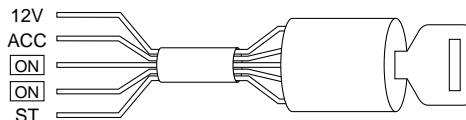
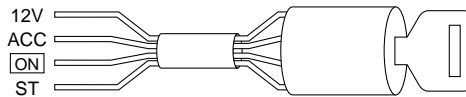

Wiring Procedure:

- (1) Cut the Power harness close to the 3-pin connector
- (2) Use a volt meter or test light to find the appropriate wires. Connect the Red wire to the 12v, the Green to to ON, and the Blue to ACC using solder.
- (3) Cover all connections carefully with electrical tape.

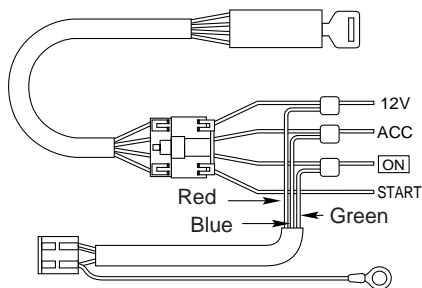

Standard Ignition

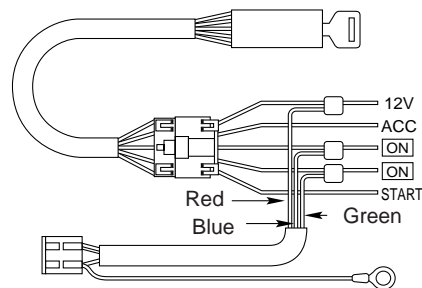

w/ 2 Ignition Wires

Warning

With vehicles that have 2 ignition (ON) wires, connect the Green wire to the ignition (ON) wire which does not drop voltage when the starter is activated. Then connect the Blue wire to the other ignition wire.

Harness Connections

Parking Brake Feature:

- (1) Remove the cover over the parking brake and find the parking switch wire(s). (see your factory service manual)
- (2) * If there is one wire, make sure the wire:
shows 0 volts, when the parking brake is engaged.
and shows 12 volts, when the parking brake is released.
* If there are two wires, find the wire that:
shows 0 volts, when the parking brake is engaged.
and shows 12 volts, when the parking brake is released.
- (3) Route the Brown wire from the 2-pin connector to the parking brake switch you found in (2).
- (4) Connect the Brown wire to the wire found in (2)
- (5) Replace the parking brake cover.

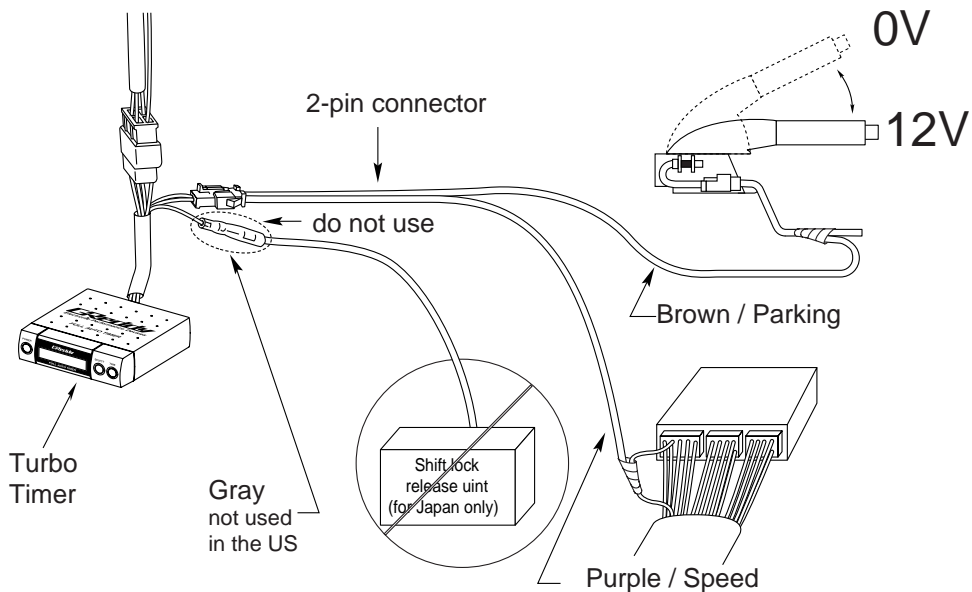

Speedometer / Auto timer Feature:

(Some vehicles do not have a speed signal to connect)

- (1) Check your factory service manual for the proper speed signal wire.
- (2) Access the speed signal wire on the ECU harness.
- (3) Connect the Purple wire to the speed signal wire.

Note: This feature should only be attempted by a trained mechanic, serious electrical damage can result from improper installation.

Turbo Timer Functions

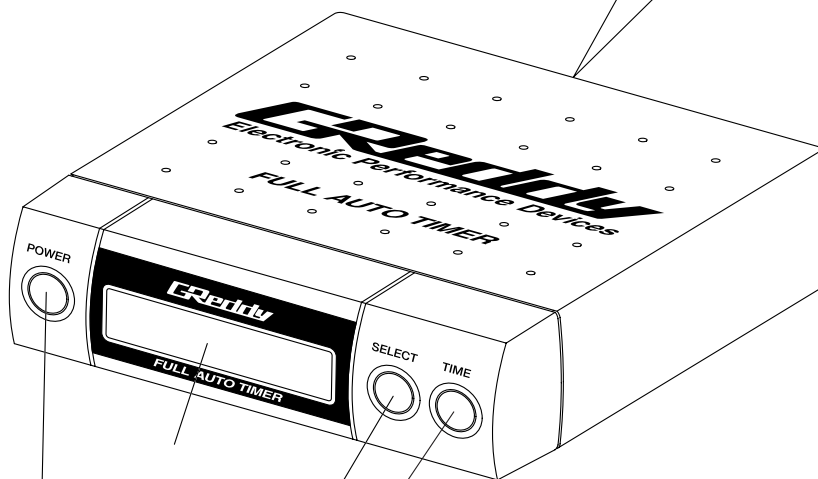
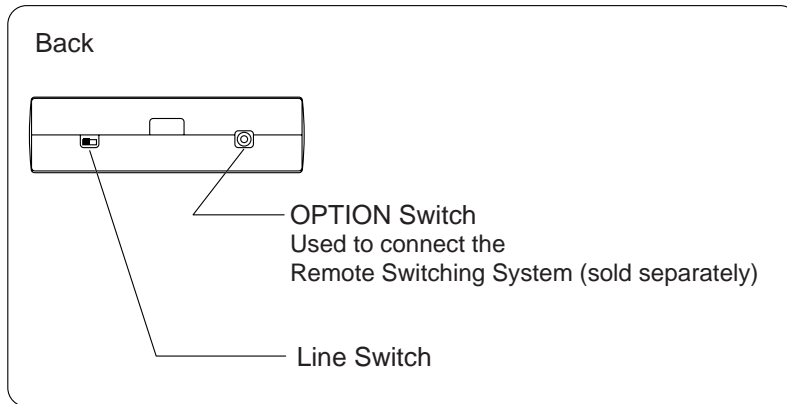

TIME Button (Referred as "T")
Used when switching the main modes.
Used to change the countdown time and set-up time.



SELECT Button (Referred as "S")
Used when switching the sub modes.
Used to start the stopwatch mode.



POWER Button (Referred as "P")
Turns the Turbo Timer "ON" or "OFF"
Used when switching the main and sub modes.
Shuts off engine and timer during count down.

Display Description

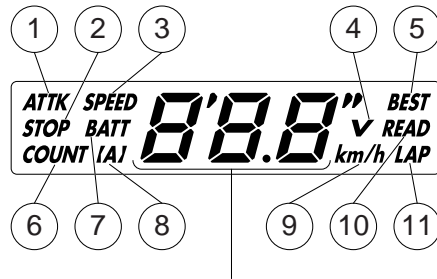

- ① **ATTK** Attack Mode indicator. Flashes when Attack timer is activated.
- ② **STOP** Stopwatch Mode indicator. Flashes when the stopwatch is activated.
- ③ **SPEED** Speed Mode indicator.
- ④ **V** Displayed while in Battery Mode.
- ⑤ **BEST** Best lap time indicator. Flashes the best lap time during Stopwatch Mode.
- ⑥ **COUNT** Count Down Mode indicator.
- ⑦ **BATT** Battery Mode indicator.
- ⑧ **[A]** Auto Mode indicator in the Count Down Mode.
- ⑨ **km/h** Displayed while in Attack mode or Speed Mode.
- ⑩ **READ** Displayed while in Stopwatch Mode.
- ⑪ **LAP** Displayed with lap time while in Stopwatch mode.

Display Description

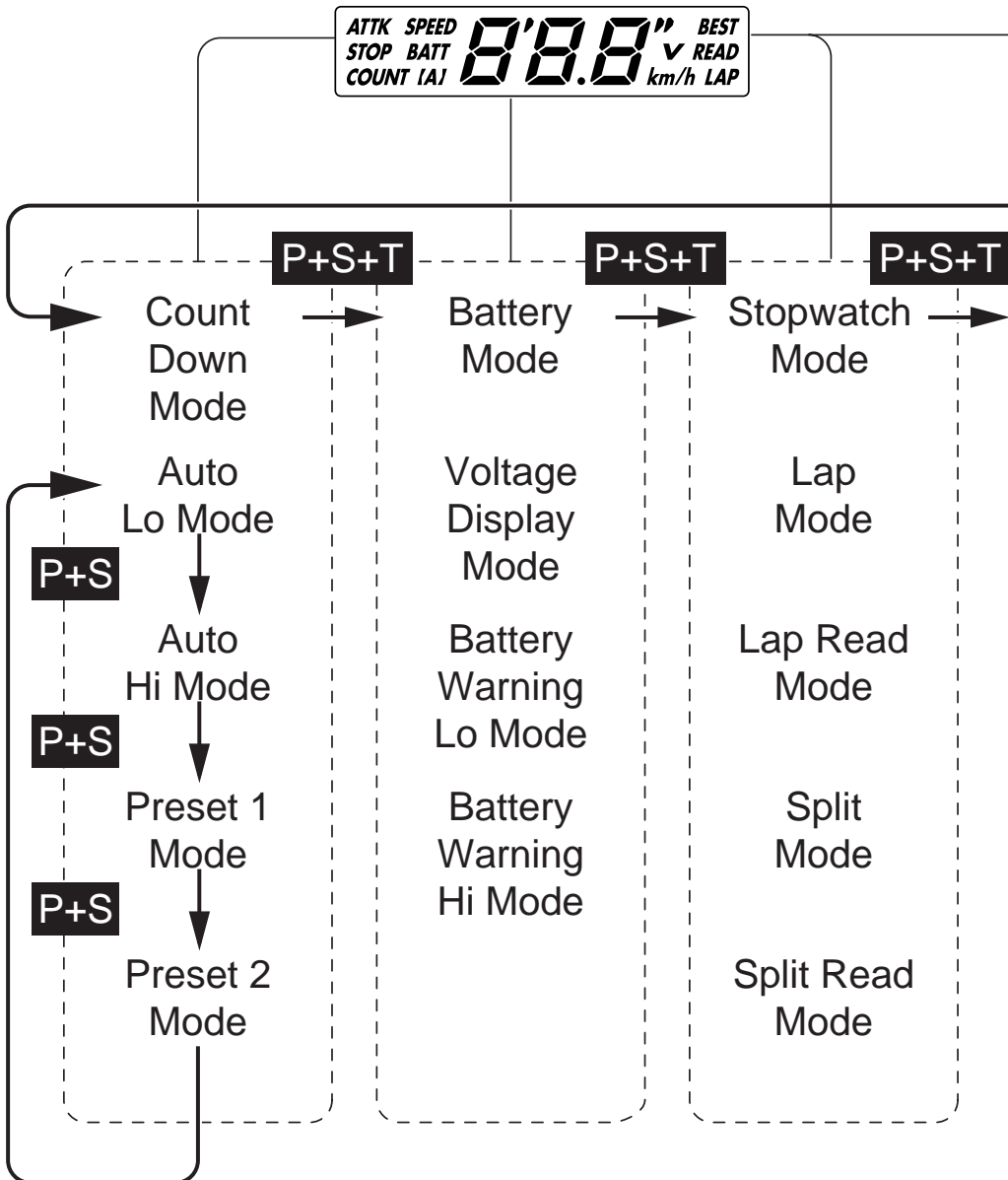

Display Description

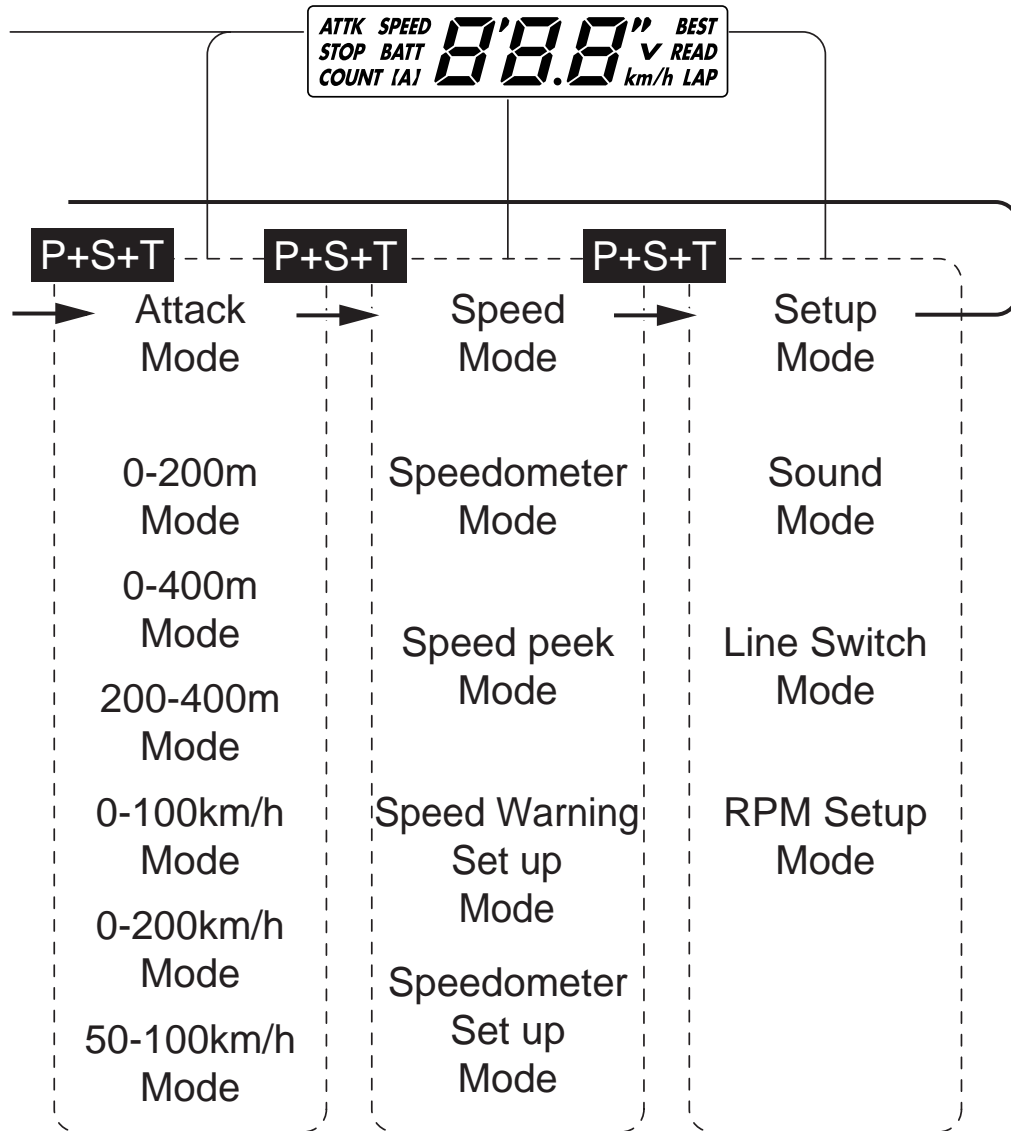

Operation Check

Parking Brake Safety Feature Operation Check

- (1) Engage parking brake.
 Manual Transmission: Place into Neutral
 Automatic Transmission: Place into Park.
 Start the engine. Make sure the Turbo Timer powers up with the music and display lights operating. (note: The Turbo Timer may be turned "Off" if so, press the "POWER" button once to turn on the unit)
- (2) Press **P + S** to select to "P-1" or "P-2" Mode.
- (3) 1'00" will show in display.
- (4) First depress the brake pedal, so that the car does not roll, then turn the ignition "Off" with the key switch.
- (5) The Turbo Timer will then give a warning "beep" and display "Sid" Next the unit should begin the counting-down mode.
- (6) Reengage the Parking Brake.
 Check to see if the "Sid" display disappears and the unit continues to count-down.
- (7) Now release the Parking Brake.
 the count down should stop and "OFF" displayed. Then the Timer and engine should immediately turn off.

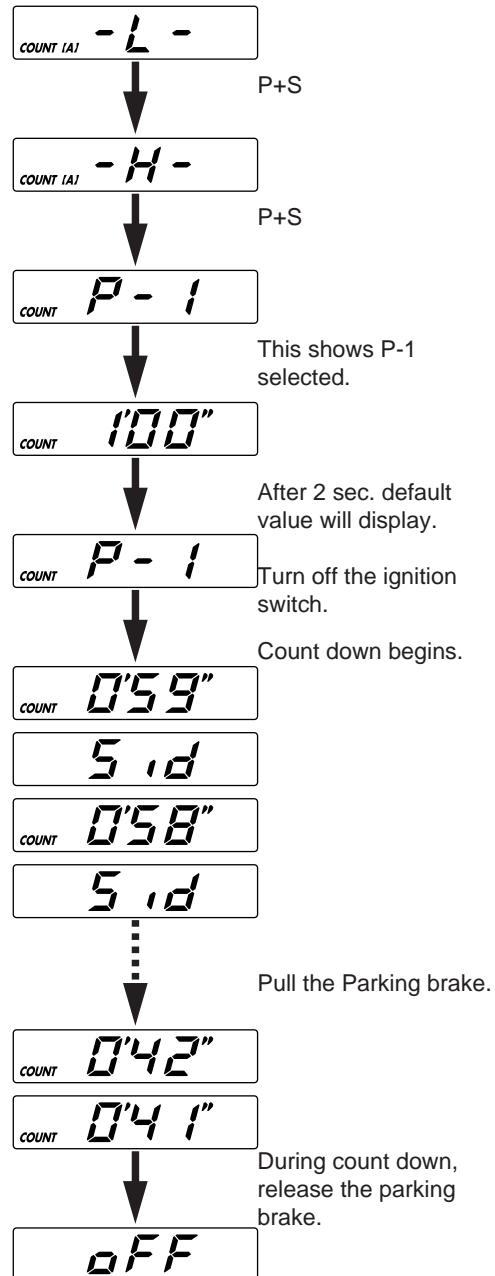

Operation Check

Vehicle Speed Signal Safety Feature Operation Check

Warning !

Before moving your vehicle, be sure that the area around your vehicle is clear. If not, you may cause an accident.

- (1) Go over check procedure 4.3 "Parking Brake Feature Check" before continuing.

COUNT 1'00"

Turn off the key switch

COUNT P-1

COUNT 0'59"

S id

COUNT 0'58"

S id

- (2) Carefully, place the vehicle into gear and move the vehicle slowly. Turbo Timer and engine should then turn off.

COUNT 0'42"

During count down, Place the car in gear and move the vehicle.

COUNT 0'41"

This concludes the check procedures.

OFF

Timer and engine should turn off.

If the Turbo Timer did not power up, or these safety features are not working, please recheck all the wiring connections and then contact your Authorized GReddy Dealer.

Countdown Mode

Auto Countdown Mode

Auto Timer Mode automatically calculates a suggested count down time for your vehicle, according to your car's RPM. You may also choose 2 count down time offset ratios "Hi" or "Lo". This will add a preset time to your calculated count down time.

On some vehicles, there is a possibility that the Auto Mode will not function properly due to difference in usable rpm range.

The Turbo Timer begins calculating, when your RPM reaches approximately 3000 RPM for "LO" mode and 2000 RPM for "HI" mode.

A minimum value can be set from 0 sec. to 1 min 30 sec. by increments of 10 sec. The factory setting is 0 sec.

Auto Timer Minimum Setting

- (1) Press the **P+S** switch to display -L- or -H-. Two sec. later, the current minimum offset value will be displayed.
- (2) By pressing the **T** switch (once), you can increase the minimum value by 10 sec. increments
- (3) By holding down the **T** switch, you can increase the minimum value by 30 sec. increments
- (4) 3 sec. after releasing the **T** switch, the unit will alert a confirmation beep. Then the unit will switch back to -L- or -H- mode. (2 sec. later the current minimum value will be displayed.)

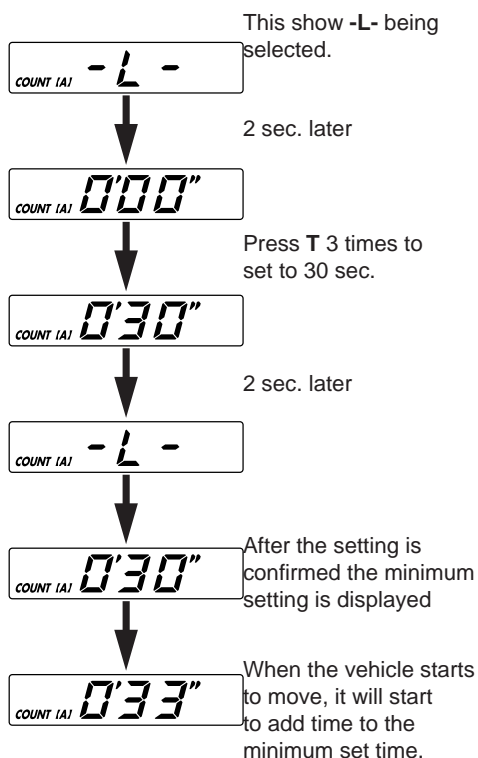

Countdown Mode

Preset Mode

There are two Preset Countdown mode you can select from.
Preset mode can be set from 0 sec. to 9 min 59 sec. by increments of 10 sec.

The factory setting is: 1 min. for P-1
3 min. for P-2

Preset Countdown Mode Setting

- (1) Press the **P+S** button to display P-1 or P-2. Two sec. later, the current minimum offset value will be displayed.
- (2) By pressing the **T** button (once), you can increase the preset value by 10 sec. increments
- (3) By holding down the **T** button you can increase the preset value by 30 sec. increments
- (4) 3 sec. after releasing the **T** button, the unit will alert a confirmation beep. Then the unit will switch back to P-1 or P-2 mode.

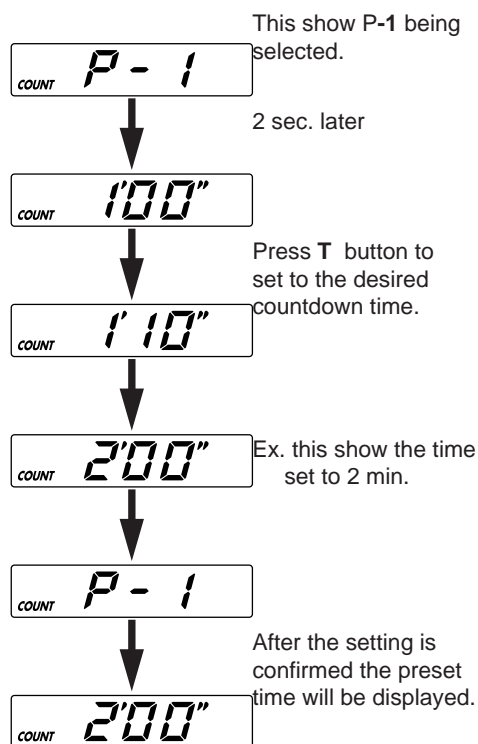

Battery Mode

Battery Voltage Display Mode

This feature displays the "real-time" battery voltage. There is a voltage warning feature that can be turned on and off. The warning buzzer and the back light will flash when the voltage exceeds the set voltage.

- (1) To go to the Battery Mode from Countdown Mode, press **P+S+T** buttons and release **S** button first.
- (2) **V** will display with the "real-time" voltage.

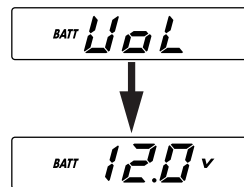

"Real-time" battery voltage will display.

Battery Mode

Voltage Warning Display Mode

When the Warning is set, the warning buzzer and the back light will flash when the voltage exceeds the set voltage.

This feature will only work while in battery mode.

(1) Press the **P+S** button to display -L- or -H-. Two sec. later, the current minimum offset value will be displayed. At this time the back light will turn red.

(2) By pressing the **T** button (once), you can increase the voltage value by 0.1V increments.
Range for -L- setting is 10.0 ~ 12.0V
Range for -H- setting is 14.0 ~ 16.0V

(3) By holding down the **T** button you can increase the voltage value by 0.5V increments

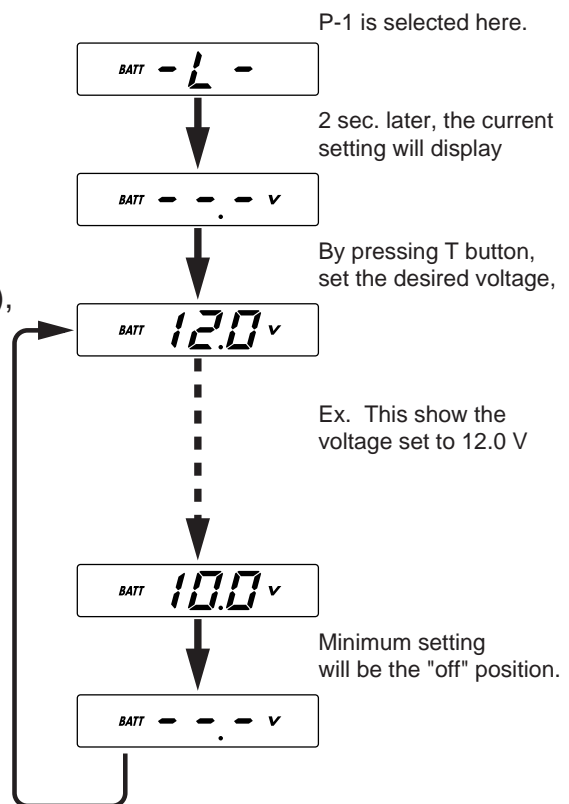

Stopwatch Mode

Lap Mode

This feature can record up to 30 lap times from 0 ~ 9' 59" 99. Also while recording the time, the best lap will be indicated by "BEST" on the display.

- (1) Press the **P+S+T** button to go to Stopwatch Mode. Two sec. later, **0'00"** will display.



2 sec later, Standby mode will display.



*if there are recorded time stored in the memory, the **0'00"** will flash. To clear the memory, hold down **T** button over 5 sec.



press S button to start.



press T button

- (2) By pressing the **S** button once, the stopwatch will start.



If the displayed time is the best lap time, "BEST" will show up on the display.



- (3) Press the **T** button to store and display the lap time. To stop, press the **S** button once.



press S button to stop the last recorded lap time will display.

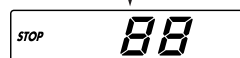

Stopwatch Mode

Lap Read Mode

This feature allows the user to look over the recorded lap times. Up to 30 lap time can be recalled one by one. The best lap time will be indicated with "BEST" shown in the display.

(1) While in Stopwatch Mode, press the **P+S** button to go to Lap Read mode. L-1 will display indicating lap 1.

(2) Press the **T** button once to go to the next lap time stored

(3) After the last lap time is displayed, it will return to L-1.

To clear the memory, hold down **T** button over 5 sec.

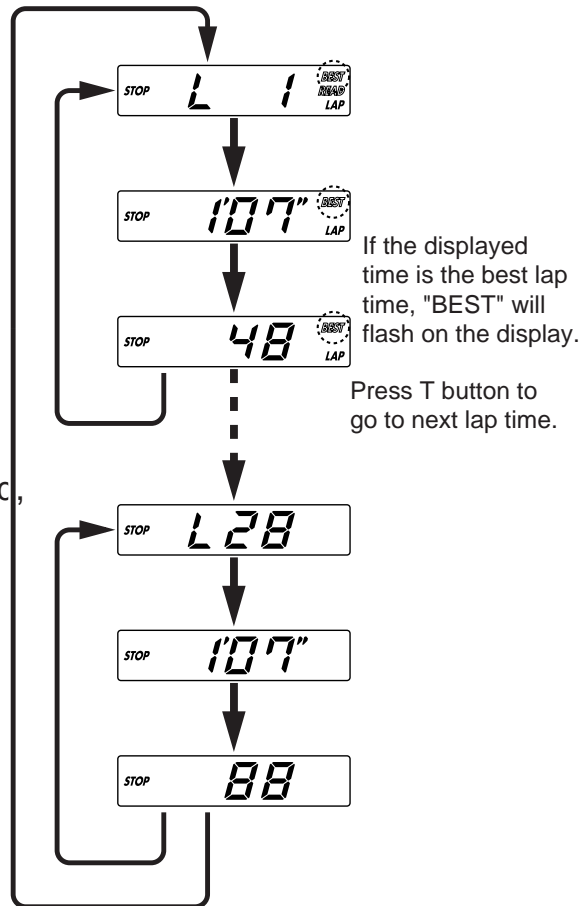

Stopwatch Mode

Split Mode

This feature can record up to 10 split times from 0 ~ 9' 59" 99. Lap time can also be recorded at the same time.

- (1) While in the Stopwatch mode, press the **P+S** button to go to Split Mode. Two sec. later, **0'00"** will display.

*if there are recorded time stored in the memory, the **0'00"** will flash. To clear the memory, hold down **T** button over 5 sec.

- (2) By pressing the **S** button once, the stopwatch will start. At each split point, press **T** button to store and display the lap time.

- (3) After the lap time, the display will show the current count time. To stop, press the **S** button once.

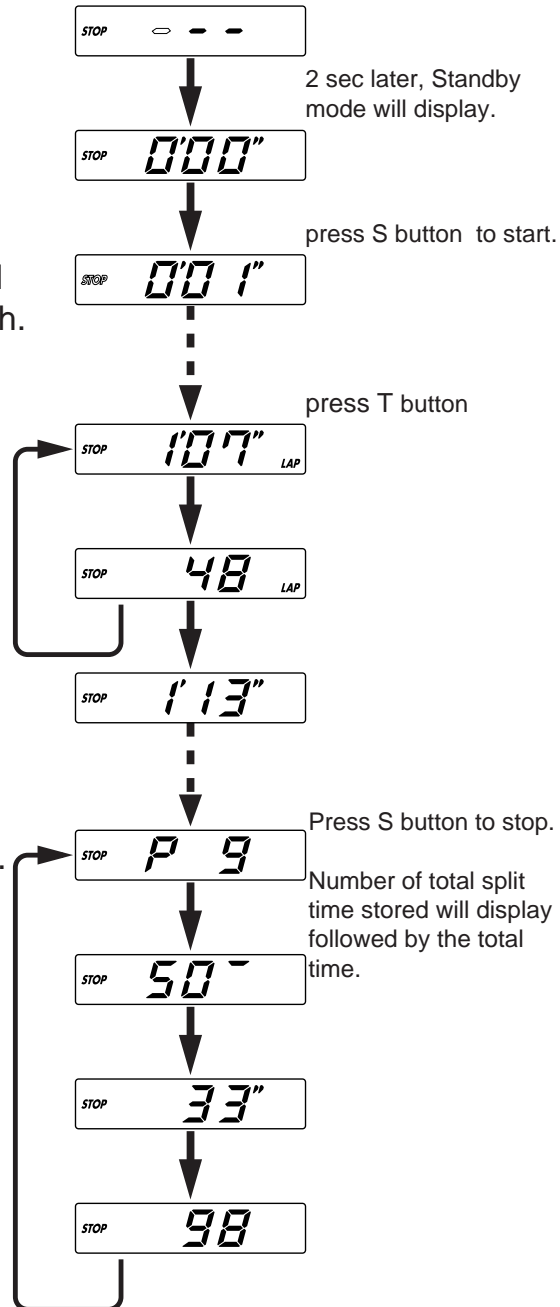

Stopwatch Mode

Split Read Mode

This feature allows the user to look over the recorded split times. Up to 10 split time can be recalled one by one in order. Lap time can also be recalled at the same time.

(1) While in Stopwatch Mode, press the **P+S** button to go to Split Read mode. P-1 will display indicating Split point 1 followed by the recorded time.

(2) Press the **T** button once to go to the next split time stored. At any time hold down the **S** button to recall the lap time. Once you release the **S** button, it will return to split times.

(3) After the last split time is displayed, it will return to P-1.

To clear the memory, hold down **T** button over 5 sec.

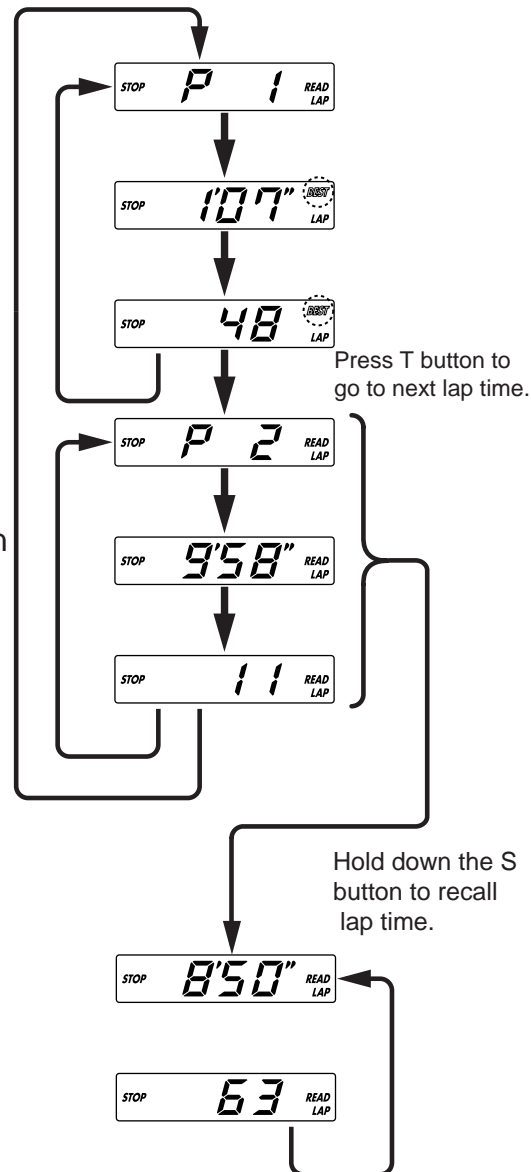

Attack Mode

0-200m, 0-400m, 200-400m, 0-100km/h, 0-200km/h, 50-1000km/h Mode

This feature allows the user to record 0-200m, 0-400m, 200-400m, 0-100km/h, 0-200km/h, 50-1000km/h times.

Important! - This feature should only be used on a race track where it is safe. Please never try on the public highways.

*This feature requires the wiring of the vehicle speed sensor signal wire.

*To record 0-200km/h time, the vehicle must be equipped with speed limiter cut device.

(1) Press **P+S+T** to go to main Attack Mode. In the attack mode, press **P+S** button to go to one of the sub Attack Mode. 0' 00" will display indicating that the unit is in stand-by mode.

* When this feature is selected while the vehicle is moving, 0' 00" will flash indicating that the unit is not in stand-by mode. Always stop the vehicle before selecting this feature.

* When the unit is in stand-by mode, press the **T** button to start the count down start. This will not work for the 200-400m & 50-100km/h mode.

* If there are data stored in the Attack Mode memory, --- will flash. To clear the memory, hold down **T** button over 5 sec. or change to different sub mode.

(2) The auto start timing is triggered by the vehicle speed sensor. The timing will start as soon as the vehicle starts to move.

(3) The recorded time will be displayed until the mode is changed or cleared.

* To restart the timing in the same mode, or to cancel the timing, hold down **T** button over 5 sec. to clear. Then the unit will return to stand-by mode.

Attack Mode

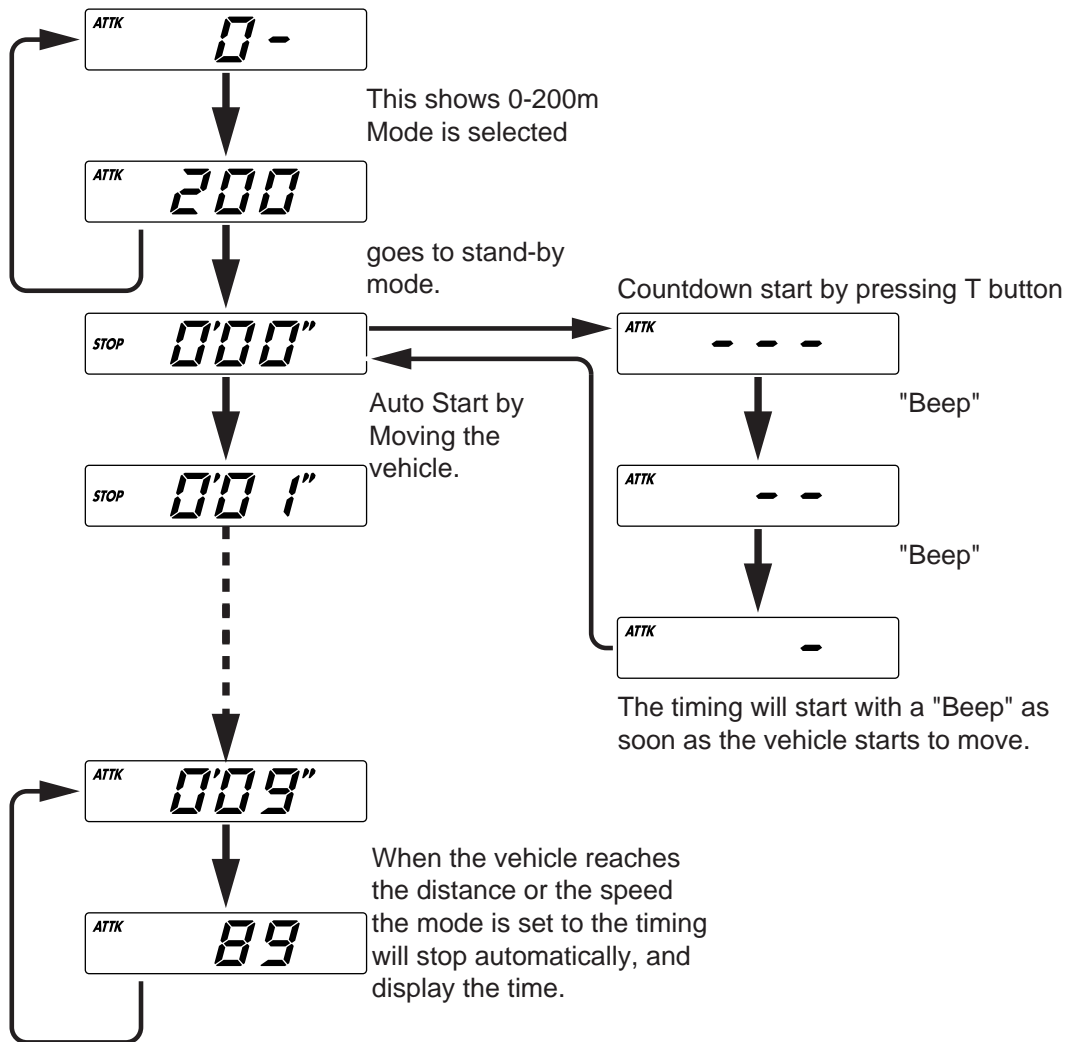

Speed Mode

Speedometer Mode

This feature allow the user to monitor the "real time" vehicle speed. With use of the Speed Warning feature, buzzer and flashing back light will warn the driver when the speed exceeds the set warning speed.

(1) Press the **P+S+T** button to go to main Speed Mode.

* Speedometer display range is 0 ~ 399km/h.

SPEED **SPd** km/h



The current speed will display.

SPEED **0** km/h

Speed Peek Mode

This feature will display the highest speed recorded while in Speed Mode.

(1) While in main Speed Mode, press the **P+S** button to go to Speed Peek Mode. -P- will display followed by the current peek speed.

SPEED **-P-** km/h



The current peek speed will display.

SPEED **0** km/h

* To clear the memory, hold down **T** button over 5 sec.

Speed Mode

Speed Warning Mode

This feature allow the user to set the warning speed to warn the driver when the speed exceeds the set warning speed with a buzzer and flashing back light.

*This feature only work while in the Speed Mode

(1) While in Speed Mode, press the **P+S** button to go to Speed Warning Setup mode. SET will display followed by the current warning setting.

* the warning range is:
0 ~ 399 km/h.

(2) Press the **S** button to change the set position. Press the **T** button to change the numbers.

(3) Press the **S** button when the speed is set. This will complete the set up.

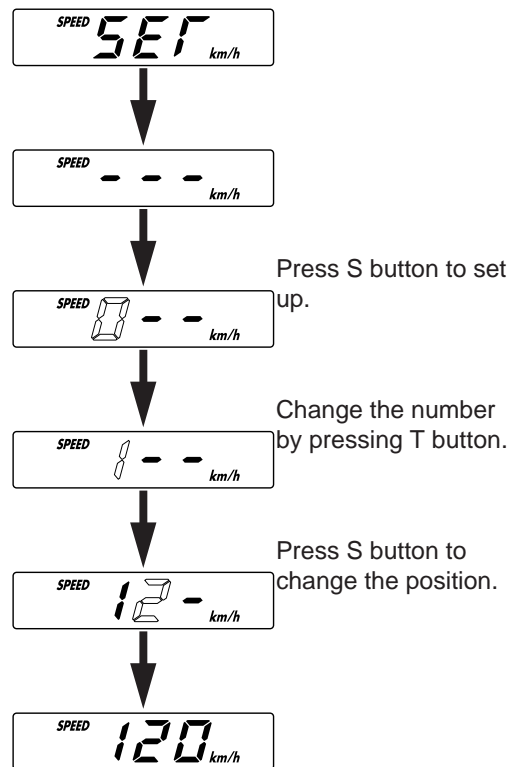

Speed Mode

Speedometer Setup Mode

This feature allow the user to set the Turbo Timer speedometer to match the vehicle's speedometer.

- (1) While in Speed Mode, press the **P+S** button to go to Speedometer Setup mode.
- (2) Get the vehicle speed up to 40km/h. Press the **T** button to set the speed.
- (3) When the setup is complete, 40km/h will display.

* To clear the memory, hold down **T** button over 5 sec. and repeat the procedure above.

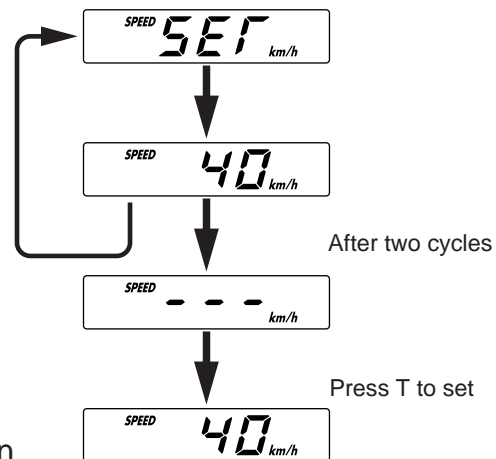

Important! - Make sure you perform this step with a passengers help. Have the passenger operate the Turbo Timer while the driver concentrate on driving safely.

* There is a possibility that the vehicle's speedometer and the actual vehicle speed.

Setup Mode

Sound Mode

This feature allow the user to turn the sound ON or OFF.

(1) While in Setup Mode, press the **P+S** button to go to Setup mode. Sud will display indicating Sound Mode.

(2) Hold down the **T** button for 5 sec to turn OFF.

* Hold down the **T** button for 5 sec again to turn the sound back on.

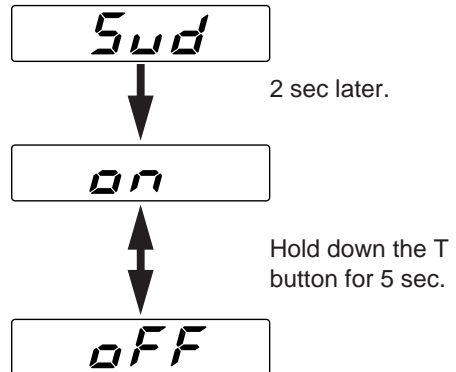

Setup Mode

Line Switch Mode

This feature is used when the count down does not properly operate. If the engine shuts down when the IG key is turned off with out counting, follow these instructions.

(1) While in Setup Mode, press the **P+S** button to go to Line Switch mode.

(2) Hold down the **T** button for 2 sec to change to Acc.

* Hold down the **T** button for 2 sec again to change back to IG

(3) Change the switch on the back of the head unit to Acc.

* Make sure that both of these setting matches for proper operation.

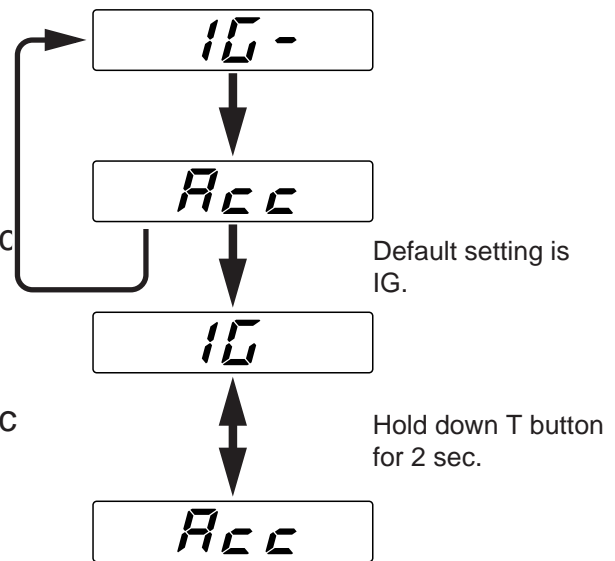

Back of the head unit

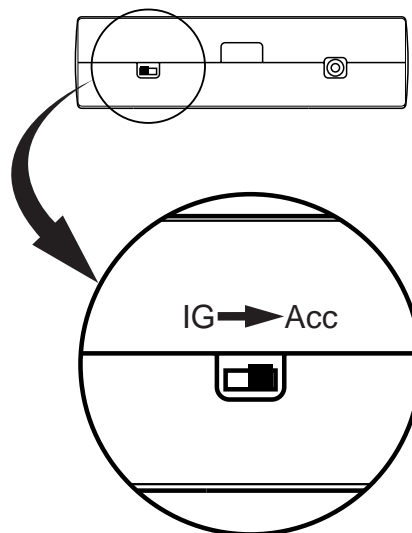

Setup Mode

RPM Set Mode

This feature is used when the Auto Mode does not operate properly or to set the Turbo Timer RPM to match the vehicle's tachometer.

(1) While in Setup Mode, press the **P+S** button to go to RPM Set mode.

(2) The current RPM will display, If the RPM does not match the vehicle's tachometer, bring the engine speed to constant RPM (2000 or 3000) and press S button once. The number on the very left will start to flash.

* After this step, let the engine idle.

* Set the RPM to the engine speed where the S button was pressed.

(3) Press the **T** button to change the numbers. Press the **S** button to change the set position.

* Make sure that both of these setting matches for proper operation.

